

This document reproduces the complete and unabridged text of a United States Army Field Manual first published by the Department of the Army, Washington DC.

All source material contained in the reproduced document has been approved for public release and unlimited distribution by an agency of the US Government. Any US Government markings in this reproduction that indicate limited distribution or classified material have been superseded by downgrading instructions that were promulgated by an agency of the US government after the original publication of the document.

No US government agency is associated with the publishing of this reproduction.

Digital viewer interface reformatting, viewer interface bookmarks and viewer interface links were revised, edited, ammended, and or provided for this edition by I.L. Holdridge.

This page and the viewer interface reformatting  
© I.L. Holdridge 1999.  
All rights reserved.

# LIGHT ARMOR OPERATIONS

## CONTENTS

	Page
PREFACE.....	ii
CHAPTER 1. INTRODUCTION.....	1-1
CHAPTER 2. COMMAND, CONTROL, AND COMMUNICATIONA.....	2-1
CHAPTER 3. CONTINGENCY OPERATIONS.....	3-1
CHAPTER 4. LIGHT ARMOR PLATOON.....	4-1
CHAPTER 5. LIGHT ARMOR COMPANY.....	5-1
CHAPTER 6. LIGHT ARMOR BATTALION.....	6-1
CHAPTER 7. COMBAT SUPPORT.....	7-1
CHAPTER 8. COMBAT SERVICE SUPPORT.....	8-1
APPENDIX A. Airlift Operations.....	A-1
APPENDIX B. Light Infantry Division.....	B-1
APPENDIX C. Arborne Division.....	C-1
APPENDIX D. Air Assault Division.....	D-1
APPENDIX E. Fratricide Reduction.....	E-1
GLOSSARY.....	Glossary-1
REFERENCES.....	References-1
INDEX.....	Index-1

DISTRIBUTION RESTRICTION. Approved for public release; distribution is unlimited.

## **PREFACE**

FM 17-18 is the Army's manual containing doctrine, tactics, and techniques for the employment of light armor units. It will assist light armor battalion commanders, their staffs, company commanders, and platoon leaders in the conduct of combat operations with light infantry. It also provides light infantry leaders with a familiarization of the capabilities of light armor units and offers techniques for deploying them effectively. The tactics, techniques, and procedures discussed in this manual also apply to armored units when employed as part of a light infantry operation.

This manual addresses two objectives. First, it gives an overview of doctrinal principles for the employment of light armor forces. Secondly, it describes tactics, techniques, and procedures for light armor platoons, companies, and battalions where they may differ from armored forces.

This manual is fully compatible with doctrine as contained in FM 100-5, and is consistent with current doctrine in FM 100-15 and FM 71-100. It assumes that the user has a fundamental understanding of these manuals and FM 101-5-1, FM 71-2, FM 71-1, and FM 17-15. It serves as a reference for personnel involved in the conduct of training.

The proponent of this publication is HQ TRADOC. Submit changes for improving this publication on DA Form 2028 (Recommended Changes to Publications and Blank Forms) and forward it to Commandant, US Army Armor School, ATTN: ATSB-SBD-D, Fort Knox, KY 40121.

Unless this publication states otherwise, masculine nouns and pronouns do not exclusively refer to men.

**CHAPTER 1  
INTRODUCTION**

The land warfare strategy of the US military has changed. The nation no longer relies on large, forward-deployed forces, supported by reinforcing forces from the continental United States (CONUS). The military forces have developed a strategy of rapidly projecting combat power from CONUS to protect national interests. The Army now focuses on deploying and fighting as part of contingency and reinforcing forces. Light armor gives the Army a versatile, deployable, and lethal force structure that can operate with light infantry-based contingency forces worldwide.

<b>CONTENTS</b>	
	Page
<b>Section I. The Role of Light Armor . . . . .</b>	<b>1-1</b>
General . . . . .	1-1
The Scope of Operations . . . . .	1-3
Light Armor in Operations Other Than War. . . . .	1-4
<b>Section II. The Threat. . . . .</b>	<b>1-6</b>
The Potential Threat Array . . . . .	1-7
The Operational Environment . . . . .	1-7
<b>Section III. Light Armor Capabilities and Limitations. . . . .</b>	<b>1-8</b>
Capabilities . . . . .	1-8
Limitations . . . . .	1-8
<b>Section IV. Fundamentals of Light Armor Employment. . . . .</b>	<b>1-9</b>
Offensive Operations . . . . .	1-9
Defensive Operations . . . . .	1-10
Retrograde Operations . . . . .	1-11
Reconnaissance Operations . . . . .	1-12
Security Operations . . . . .	1-12
Battlefield Operating Systems . . . . .	1-13

**Section I. The Role of Light Armor**

**GENERAL**

Light armor will use its unique capabilities to conduct combat operations, often in support of contingency plans, across the operational continuum (peacetime, conflict, and war). It will be required to operate in a wide range of political, military, and geographical environments. Its tactical missions include providing security, reconnaissance, and antiarmor firepower to the light infantry division (LID) or airborne corps, as well as standard armor operations to engage and destroy enemy forces using mobility, firepower, and shock effect in coordination with other combat arms. These missions may require rapid strategic and tactical deployment worldwide.

**M8 Light Tank.** Currently, light armor units are equipped with the M551A1 (TTS) armored reconnaissance airborne assault vehicle. The M551A1 will be replaced by the M8 light tank. The light tank will be an air-deliverable, all-weather, mobile, protected direct-fire platform. It will be able to engage enemy bunkers, buildings, armor systems, and personnel in close or built-up terrain. The light tank has a three-man crew and is armed with a 105-mm cannon with autoloader and caliber .50 and 7.62-mm machine guns.

The light tank will add a new dimension to the combined-arms capability of light forces, but it is not intended to replace the main battle tank. *The primary purpose of M8 light tank forces is to operate with light infantry during rapid-deployment contingency operations (CONOPS).* They immediately provide the rapid-deployment commander with an armored system that can counter a variety of threats until heavier forces arrive in theater. Initial light tank forces can be air-delivered using low velocity air drop (LVAD) procedures, followed closely by forces arriving by airlifting transportation assets (see Appendix A).

**Missions.** Light armor forces may be required to support the following missions:

- Operations other than war, such as—
  - Insurgency/counterinsurgency.
  - Combating terrorism.
  - Emergency relief operations.
  - Shows of force and demonstrations.
  - Noncombatant evacuation operations (NEO).
  - Strikes and raids.
  - Peacekeeping and peace enforcement.
  - Other operations as specified by higher commanders.
- Rapid reinforcement of forward-deployed forces.
- Wartime contingency operations.

These missions will require separately supportable light armor units to conduct a variety of tasks, including—

- Close assaults with light infantry.
- Reduction of strongpoints, bunkers, and roadblocks.
- Operations in built-up areas (BUA).
- Defense with light infantry.
- Force security.
- Flexible, mobile reserve operations for the light infantry task force (TF), brigade, division, and corps to provide rapid response to enemy mounted forces.
- Rear area operations.

**Contingency Operations.** Light armor is most likely to be employed as part of CONOPS, which dictate an increased role for armor operating with light forces. Light armor significantly reduces the risks light forces face during CONOPS. Its capabilities also enhance the combat capability and lethality of the light force.

As part of an airborne corps, the light armor unit may be required to execute opposed-entry operations and provide immediate direct-fire support for initial-entry light forces. Entry into contingency theaters may require opposed entry by air. As noted, elements of the light armor force will be capable of insertion by LVAD or airlanding, as required. Appendix A discusses these procedures in more detail.

Light armor increases the contingency force's mobile, protected lethality immediately upon deployment. It provides accurate, destructive fires that the operational commander can use to shape the battlefield, defeat the enemy, or fill the gap until other armored forces arrive.

Light armor forces support the contingency force commander's requirement to conduct operations in wartime as well as in operations other than war. They can execute peacetime CONOPS aimed at influencing enemy decisions through political and psychological shock effect, or they can engage and defeat the enemy in combat.

## THE SCOPE OF OPERATIONS

The strategic environment within a theater comprises a variety of conditions (political, economic, military) and potential threats. The interaction of these factors can result in a wide range of operations for the light armor unit. These operations are conducted within a scope of operations consisting of three general environments: peacetime, conflict, and war. This discussion of the scope of operations focuses on the conditions that define each environment and the types of operations light armor may conduct.

Light armor can operate along the entire scope of operations. It may support a contingency that is the only ongoing operation in peace or conflict or be deployed in an environment of war in a separate, concurrent operation within the same theater or a different one. Although the discussion of the environments describes each separately, there are no precise distinctions as to where one environment ends and another begins.

**Operations Other than War.** Operations other than war entail political-military confrontations between contending states or groups, frequently involving protracted struggles of competing principles and ideologies. In the scope of operations, it includes the peacetime and conflict environments. Ranging from subversion to use of armed force, it is waged by a combination of political, economic, informational, and military elements. Operations other than war occur most often in the third world, but it can have regional and global security implications.

**Peace.** Political, economic, informational, and military measures, short of combat operations or active support of warring parties, are employed to achieve national objectives. Within this environment, US forces may conduct training exercises to demonstrate resolve; conduct peacekeeping operations; participate in nation-building activities; conduct disaster relief and humanitarian assistance; provide security assistance to friends and allies; or execute shows of force. During peace, confrontations and tensions may involve the clear threat or the actual use of armed force; such a situation may reach a point of transition to a state of conflict.

**Conflict.** Conflict is an armed struggle or clash between organized parties within a nation or between nations to achieve limited political or military objectives. While regular forces are often involved, irregular forces frequently predominate. Conflict is often protracted, confined to a restricted geographic area, and constrained in weaponry and level of violence. In this state, military power in response to threats may be exercised in an indirect manner while supporting other elements of national power. Limited objectives may be achieved by the short, focused, and direct application of force.

Conflict also describes situations in which continuing clashes or crises occur over boundary disputes and land and water territorial claims. Conflict also includes situations in which

opposing political factions engage in military actions to gain control of political leadership within a nation. Conflict approaches the threshold of a state of war as the number of troops, frequency of battles, number of nations, and level of violence increase over an extended period of time. Conflict also can evolve into a state of war anytime the sovereignty of a nation is threatened.

Military operations involving light armor occur most often in this state. Operations may include offensive, defensive, retrograde, security, and reconnaissance missions.

**War.** War is the sustained use of armed force between nations or organized groups within a nation; it involves regular and irregular forces in a series of connected battles and campaigns to achieve vital national objectives. War may be limited, with some self-imposed restraints on resources or objectives. Conversely, it may be general, with the total resources of a nation or nations employed and national survival of one or more combatants at stake. Total war between superpowers is the most catastrophic, though least likely, form of warfare. It could engulf countries, alliances, or entire continents and become true global warfare, with battles raging in a number of theaters.

In the state of war, light armor would most likely be involved in an operation on the periphery of the main effort, such as an economy of force or security role. Light armor would also be useful as part of a CONOPS in a part of the theater away from the main effort. The deployability of light armor would allow it to move rapidly to another area or theater in the event other crises arose.

## LIGHT ARMOR IN OPERATIONS OTHER THAN WAR

The Army's mission in operations other than war are divided into activities. See FM 100-5 for additional information on these activities. These are all neatly defined, distinct categories, yet they often overlap. Peacekeeping forces, for example, must protect against terrorism; on the other hand, a terrorist incident may result in a peacetime enforcement operation.

All such missions require continuous emphasis on intelligence. Before the force is committed, intelligence must be collected, processed, and focused to support all planning, training, and operational requirements. Intelligence is crucial during execution of operations other than war. The threats faced by military forces in these operations are more ambiguous than those in other situations because guerrillas and terrorists can blend with the civilian population. (See FM 100-20 for additional information on operations other than war.)

**Armor Employment Considerations.** The following paragraphs discuss the roles of light armor, airborne armor, and fully armored forces (tank and mechanized infantry units) as they relate to operations other than war.

**Light.** Normally, light armor is the most appropriate armor force to conduct a rapid crisis response. Two major considerations when employing light armor are suitability and availability. All factors of mission, enemy, terrain, troops and time available (METT-T) must be weighed carefully in selecting the most suitable force to support accomplishment of the host nation's overall objective.

**Airborne.** The major difference between airborne armor forces and other light armor forces is the capability of parachuting into an area. An airborne light armor unit conducts ground tactical operations in the same manner as other light armor units. The primary advantage of using this type of force is that it enables the airborne commander to position an armor force in a short time. In most cases, airborne operations will insert forces into suitable areas in all phases of operations other than war. In addition, this method provides a relatively clandestine means of inserting elements into a controlled or contested area. Airborne operations are dependent on several factors, including aircraft availability, terrain, and weather.

Armored. Armored forces are usually employed with accompanying infantry. As with mechanized infantry forces, however, armored forces may have difficulty maneuvering in restrictive terrain. Major advantages are their armor protection, highly lethal firepower, speed, and shock effect; these advantages are maximized in open terrain. Their capabilities are hindered and their vulnerabilities increased in restricted terrain. (See FM 71-2 for further information on armored and mechanized employment).

The light armor commander must adapt the doctrine presented in this manual to each specific situation within a particular environment. For example, each country presents unique challenges for commanders in dealing with insurgency and terrorism. Principles, policies, and programs applied successfully in one situation may be unsuitable if applied in the same manner in another situation.

Duration of light armor employment varies by situation. Insurgency or counterinsurgency may require long-term commitment of light armor elements in combat operations of short or long duration or, sometimes, in advisory or supporting roles. Capabilities of the supported force and the strength of its opposition are factors influencing involvement of combat forces and length of their stay. Some peacetime CONOPS may require a lengthy commitment, while others, such as demonstrations and raids, may be finished quickly. Anti-terrorism (a defensive operation) is a continuous requirement, whereas counterterrorism (offensive) is usually of short duration. The extent of light armor commitment may range from providing mobile training teams to conducting operations by the whole battalion as part of a division, corps, or joint task force (JTF).

**Specific Roles in Operations Other Than War.** The following paragraphs discuss the role of light armor throughout the activities in operations other than war.

Insurgency/Counterinsurgency. These operations cover assistance the US may provide to a friendly nation or group in combating or prosecuting an insurgency. Initially, US forces assess the threat to the host government and to US interests. The US supports selected resistance movements opposing oppressive regimes working against US interests. Such support is coordinated with friends and allies.

Insurgences rely on mobilization of people and resources from within the country to be successful. Because they must build legitimacy, their efforts include political, social, and (when possible) economic development. They are successful if they gain more legitimacy than the government. Basic principles of internal defense and development (IDAD) apply, especially in areas under insurgent control. Because support for insurgency is often covert, many of the operations connected with it are special activities and do not involve light armor. Light armor units are called on only when a situation requires their specific capabilities, including direct-fire support, security to indigenous resistance forces, or training, advice, and development if the insurgent force has an armor specific need. Command and control (C2) relationships are normally situation specific.

US support for counterinsurgency rests on the IDAD concept (see FM 100-20 for more details). This entails use of all the leadership, organizational, and materiel resources available to the host government. It is designed to mobilize support for the host government and preempt insurgent mobilization efforts. Security forces (military, paramilitary, and police) should defeat the insurgents' combat elements and neutralize their leadership to establish an environment of security in which development can occur.

If the host nation requests support and US interests are involved, the US National Command Authority (NCA) may direct the US Army to provide economic, political, and military assistance. Divisional operations may require civil affairs; population and resources control; psychological operations (PSYOP); intelligence; tactical operations; and training assistance. Light armor involvement, however, will normally only be in tactical operations.

One potential combat role for light armor is in counterinsurgency missions. Light armor will usually operate as platoons and companies task organized to a larger TF, brigade, or



JTF. In other scenarios, the light armor battalion will deploy as a unit or will be task organized with a division or corps. See FM 90-8 for further information on counter guerrilla operations.

**Combating Terrorism.** This role has two components: counterterrorism and antiterrorism. Counterterrorism, offensive measures taken by specially trained forces, is not discussed in this manual. In special situations, light armor could be used in offensive operations in a counterterrorism role. It would probably perform a demonstration or diversion or provide increased firepower. Antiterrorism includes all defensive actions that each soldier must practice.

**Peacekeeping Operations.** These are military operations conducted with the consent of the belligerent parties to maintain a negotiated truce and to facilitate diplomatic resolution. The US may participate in peacekeeping operations as a member of an international organization, in cooperation with other countries, or unilaterally.

A peacekeeping mission may require forces to deal with extreme tension, sabotage, and minor military conflicts from known or unknown belligerents. Common missions in peacekeeping operations include cease-fire supervision, police actions, prisoner-of-war exchanges, demilitarization, and demobilization. Armor units, including light armor, do not normally participate in United Nations peacekeeping operations; however, peacekeeping as part of a cease-fire, demilitarization, or demobilization may require light armor support.

**Peace Enforcement Operations.** Some situations may require deployment of US military forces to impose peace. These operations are often labeled peacekeeping, but are better described as peace enforcement. They differ greatly in execution from peacekeeping missions. While the ultimate objective may be to maintain peace, the initial phase in peace enforcement is to achieve it. Peace enforcement is often unilateral, possibly with some consent from the beneficiary, and it is imposed by the peace enforcement unit. Light armor forces may be needed as a security force or in a limited role to conduct a show of force or demonstration to discourage the belligerents from inciting conflict.

**Other Operations.** In certain environments, military operations become necessary when diplomatic initiatives have been, or are expected to be, ineffective in achieving extremely time-sensitive, high-value objectives. Failure to influence a belligerent nation or activity through diplomatic means may necessitate the use of military forces to protect US national interests, rescue US citizens, provide emergency relief, or defend US assets. Operations involving light armor may include strike operations, rescue and recovery, demonstrations or shows of force, NEOs, and security for relief forces (see Chapter 3).

## **Section II. The Threat**

Geopolitical factors continue to affect US military strategy. The Army must continue to deter aggression worldwide. If deterrence fails, it must be prepared to defeat enemies across the full spectrum of conflict: from all-out war against a superpower, to a conflict against a hostile regional power, to operations other than war against less sophisticated, but no less determined, insurgent forces.

Light armor must prepare to fight a variety of threat forces. These may range from crudely equipped insurgents to a technologically advanced conventional force. Regular forces can be expected to conduct standard offensive, defensive, and reconnaissance missions. Irregular forces use stealth, surprise, covert and guerrilla actions, and hit-and-run tactics.

## THE POTENTIAL THREAT ARRAY

Because of its versatility, light armor can expect to conduct combat operations across the spectrum of contingencies against determined enemies equipped with modern weapon systems. These may include nuclear, biological, or chemical (NBC) weapons, forcing light armor to conduct operations in contaminated environments. In restrictive terrain mine warfare becomes a likely threat, especially with the wide variety of antitank mines on the world market today. Additionally, an enemy's use of scatterable mines may constitute a significant advantage. Most engagements will be at closer range (300 to 800 meters) than in typical armored operations because of the types of restrictive terrain in which light armor will operate. The following is a list of potential threat targets that light armor forces must be prepared to engage:

- Nonarmored targets:
  - Bunkers.
  - Automatic weapons positions.
  - Antitank guided missiles (ATGM).
  - Troops.
  - Artillery.
  - Air defense weapon systems.
  - Motor vehicles.
  - Helicopters.
- Lightly armored vehicles.
- Tanks.

## THE OPERATIONAL ENVIRONMENT

The operational environment is a composite of the conditions, circumstances, and influences that affect employment of military forces and decisions of the unit commander. Light armor units may participate in contingency missions that cover the range of combat operations. The light armor force can expect to be employed in any environment and terrain, including tropical, mountainous, urban, and desert areas. It should train to operate in theaters that have an austere support base and poor infrastructure. Operating with light infantry, light armor must be ready to maneuver over restrictive terrain. The following paragraphs discuss the classifications of the operational environment.

**Permissive.** Host-nation military and law enforcement agencies have control of the area of operations (AO) and have the intent and capability to assist operations that a unit intends to conduct.

**Semipermissive.** The host-nation forces, whether opposed or receptive to operations that a unit intends to conduct, do not have total effective control of the territory and population in the intended AO.

**Nonpermissive.** The AO is under control of hostile forces that have the intent and capability to effectively oppose or react to the operations a unit intends to conduct. (See Joint Publication 1-02 for more information.)

## Section III. Light Armor Capabilities and Limitations

### CAPABILITIES

Light armor units have the capability to—

- Support the close fight as part of a combined arms team using accurate antiarmor fires and direct fire.
- Operate on a conventional or NBC battlefield.
- Use thermal sights to greatly enhance the night fighting capabilities of the combined arms team.
- Operate in an opposed entry role.
- Use strategic and tactical mobility to advantage.
- Provide armor protection against small arms, machine gun, and overhead artillery fire.
- Detach quickly from their parent unit and be employed during initial stages of contingency or reinforcing operations.
- Accept routine attachment of operational control (OPCON) of engineer assets and light infantry or antiarmor companies.
- Deploy tailored armor and/or reconnaissance packages with inherent C2 and logistical support. This includes requirements to pre-position units in contingency areas of operations.
- Accomplish rapid movement and limited penetrations.
- Exploit success and pursue defeated enemy elements as part of a larger force.

### LIMITATIONS

The limitations of light armor units include the following:

- The M8 light tank does not possess the level of protection of a main battle tank.
- The lightly armored M8 is vulnerable to enemy infantry with antiarmor weapons and may not withstand the impact of enemy tank fires, missiles, or antitank mines.
- Light armor is dependent on Air Force assets for deployment to the combat theater of operations. Its heavy equipment requires a large number of aircraft during the strategic deployment of an entire battalion.
- Currently, light armor requires support from the forward support battalion (FSB) and division or corps combat service support (CSS) elements to sustain operations.
- Consumption of supply items is moderate to high, especially in Classes III, V, and IX.
- Light infantry units do not have the organic transportation assets to support the light armor's CSS needs, especially in Classes III, V, and IX.
- Mobility and firepower are restricted in extremely close terrain.
- Some support equipment, such as recovery and fuel vehicles, can deploy only by airlanding assets.
- Airborne and light divisions can often provide only limited air defense and engineer support to the light armor force.

## Section IV. Fundamentals of Light Armor Employment

Light armor forces will provide combat capability throughout the battlefield and will be an integral part of the joint combined-arms contingency force. Light armor platoons and companies may be employed in conjunction with nonmounted forces of squad through brigade size as mission requirements dictate. Light armor battalions may also be employed as a division or corps maneuver force and receive support from combat, combat support (CS), and CSS units on the battlefield.

Light infantry can employ light armor units as part of its security operations. Armor and infantry can work together to conduct effective screening force operations, both offensive and defensive, to slow and direct the flow of enemy forces. Light armor, even when outnumbered, can be used to shape the battlefield, causing the enemy to deploy its armored forces into engagement areas (EA) that can be targeted with Air Force or Army aviation attack helicopters.

Light armor forces are also appropriate as reserves. Their mobility and firepower allow them to be used to strike the enemy at the critical time and place to seize or regain the initiative and ensure the destruction of the enemy force.

Light armor may also be required to perform standard security and reconnaissance missions. These may be conducted with divisional ground or air cavalry elements or alone when cavalry is not available or is not in sufficient quantities. These missions include—

- Guard (with reinforcement).
- Screen.
- Zone or area reconnaissance.
- Reconnaissance in force.
- Route reconnaissance and security.

Light armor can also perform standard armor missions that require massed, direct, heavy-caliber firepower, mobility, and shock effect. Enemy antitank capability must be carefully analyzed before light armor undertakes the following missions:

- Movement to contact.
- Hasty attack.
- Deliberate attack.
- Exploitation.
- Pursuit.

### OFFENSIVE OPERATIONS

In the offense, light armor forces should be assigned missions that capitalize on their maneuver and firepower capabilities. These include missions to destroy enemy forces, develop intelligence about the enemy, seize or control terrain, deceive and divert the enemy, deprive the enemy of resources to demoralize him, hold the enemy in position, and destroy and disrupt enemy command, control, and logistics facilities.

Light armor is used to defeat a defending enemy force by seeking decisive results in the enemy's rear and flank areas. Close combat and assaults against enemy armored forces fail to exploit light armor's strengths of speed, mobility, and agility. This does not mean light armor cannot be used during assaults. In some situations, there may be no alternative. Commanders should carefully weigh the factors of METT-T when making these decisions.

Light armor is employed using two distinct methods: as the direct- or semi-indirect fire support element or as the maneuver element. Protection, mobility, and speed are the key elements that must be synchronized between the mounted element and the dismounted element.

Light armor leaders must understand and employ the following fundamentals of offensive operations:

- Fight as a combined arms team. Light armor always fights as part of a combined arms team. Capabilities and limitations of light armor and infantry make them complementary when employed as a team.
- Know the enemy. The light armor leader must know and understand the capabilities of the enemy's weapon systems and defensive doctrine, including the enemy's capability to conduct ambushes.
- See the battlefield. The leader must know and be able to identify key terrain. He should also learn to identify covered and concealed routes during movement. The light armor leader must anticipate how the enemy will use the terrain and then determine how to counter it.
- Use weapon systems to best advantage. The light armor leader must know the capabilities and limitations of his own weapon systems. Knowing the best kill probability ranges of all weapons (main gun, machine guns, light infantry weapons) is a key. Leaders can improve kill probabilities by engaging enemy vehicle flanks.
- Concentrate combat power. The light armor leader must be able to control and concentrate weapon systems. To do this, he uses proper C2 techniques and trains his unit to shoot, move, and communicate effectively under all conditions. The leader also makes maximum use of available indirect fires.
- Use maneuver to best advantage. Light armor must move rapidly, strike first, and maintain the momentum until the enemy has been killed or captured.
- Coordinate continuous support. Light armor leaders must always be aware of their logistical status. Logistics support is extremely difficult in the austere environment of light forces. Leaders must understand the procedures for critical support, such as evacuation of personnel and equipment or resupply of ammunition and fuel. This is important because task organization changes are more frequent when light armor operates with a contingency JTF.
- Be flexible. Light armor leaders achieve flexibility by ensuring units are properly trained, by adhering to standing operating procedures (SOP) and battle drills, and by becoming tactically proficient. They must understand the commander's intent and anticipate changes in the situation that will help complete the mission.

## DEFENSIVE OPERATIONS

The three purposes of defensive operations are to—

- Gain time while waiting for more favorable conditions to conduct offensive operations.
- Economize forces in one area so superior forces can concentrate for decisive offensive operations elsewhere.
- Maintain control or possession of an objective.

The light armor unit is not ideally suited for conducting independent defensive operations. It normally operates as part of a larger force and should be assigned missions that capitalize

on its capabilities. The light tank enhances the overall defense by providing the light infantry force with a high degree of mobility and firepower.

Light armor leaders and their troops must understand and employ the following fundamentals of defensive operations:

- Understand the enemy. The light armor leader must learn the following information about the enemy:
  - Reconnaissance capabilities.
  - Weapon systems available to the enemy. NBC, artillery, and ATGM capabilities are most critical.
  - The enemy's ability to conduct dismounted attacks and raids under limited visibility conditions.
- See the battlefield. The light armor leader must position himself forward where he can best control his forces. He must assertively use a variety of assets to understand as much as he can about the situation to his front, flank, and rear. Thermal sights will augment light armor's ability to see the battlefield under all visibility conditions. The leader must also attempt to prevent the enemy from seeing the battlefield by using concealment and operations security (OPSEC).
- Concentrate fires. Light armor leaders must plan to concentrate fires to achieve decisive results. Direct and indirect fires must be brought to bear on the enemy before it can bring effective fires on friendly positions. Fires must cover protective obstacles. Leaders must take the initiative by counterattacking by fire to exploit enemy weaknesses as they arise.
- Use the advantages of the defender. Maximize combat power by knowing the terrain better than the enemy. Make the best use of terrain by—
  - Using it as a shield against enemy observation and fires.
  - Fighting from covered and prepared positions when possible.
  - Using obstacles to maximize the effects of direct and indirect fire.
  - Engaging the enemy first at the most opportune time and place, using available weapon systems to best advantage.
  - Rehearsing the plan to ensure every man knows what to do.
  - Using mobility to best advantage.
- Fight as a combined arms team. Light armor will always fight as part of a combined arms team. As noted previously, the capabilities and limitations of light armor and infantry make them complementary when employed as a team.

## RETROGRADE OPERATIONS

Retrograde operations are movements to the rear or away from the enemy. The movement may be forced or voluntary, but it must be with the higher commander's approval. Units conduct retrograde operations to gain time, preserve force strength, avoid combat under undesirable conditions, or draw the enemy into an unfavorable position. The three types of retrograde operations are delay, withdrawal, and retirement.

In a delay, units give ground to gain time. They inflict the greatest possible damage on the enemy while maintaining freedom of action. In a withdrawal, all or part of a committed force disengages from the enemy voluntarily to preserve the force or free it for a new mission. In a retirement, a force not in active combat with the enemy conducts a movement to the rear, normally as a tactical road march.

Delay is one of the most demanding missions any unit can undertake. It is also the most common retrograde mission for light armor, which uses it to trade space for time. The ability to delay is essential to success on the battlefield when an enemy force outnumbers the contingency force or has superior armored forces. Light armor is the only force in the light division structure that can conduct a high-risk delay operation against a mounted enemy. Success depends heavily upon firepower and mobility. The contingency force commander can use light armor to delay when the force's strength is insufficient to attack or defend. He may use artillery-delivered FASCAM, helicopter-delivered Volcano, and M8 direct fires to intentionally draw the enemy into an EA and expose it to attack helicopters, USAF CAS, additional M8 direct fires, and wide-area mines (WAM).

### RECONNAISSANCE OPERATIONS

Reconnaissance operations provide the commander and staff with information about the terrain and enemy. Reconnaissance verifies or refutes analyzed intelligence information. As specified in FM 71-100, any element assigned to or operating with the LID may be tasked to perform reconnaissance operations. Light armor units conduct reconnaissance to obtain information by employing movement, observation and surveillance, fire and maneuver, and special equipment. They may be required to fight to gain intelligence through combined arms teamwork with ground or air cavalry or alone if cavalry is not present or available. Light armor performs three distinct types of reconnaissance: route, zone, and area. Depending on the level performed, reconnaissance may be a separate mission or part of another operation.

### SECURITY OPERATIONS

Security operations provide information about the enemy and provide reaction time, maneuver space, and protection to the light infantry. When properly task organized, augmented, and supported, light armor units may be tasked to perform two primary types of security missions—screen and guard. The differences among these missions are the degree of security provided. The light division can employ light armor with cavalry units as part of a security operation to conduct an effective guard or screening force operation in both the offense and the defense. These operations slow and direct the flow of enemy forces into the division AO. In addition, as part of tactical operations, light armor may conduct other security missions to protect the force and its mission. These include, but are not limited to, counterreconnaissance, deception, main supply route (MSR) and convoy security, and OPSEC. The following paragraphs summarize the main types of security missions.

**Screen.** A screen provides early warning. The screening force gains and maintains enemy contact, reports enemy activity, destroys or repels enemy reconnaissance, and impedes and harasses the enemy with long-range fires. Commanders must realize that a screen can become a guard mission in a matter of minutes; therefore, they must organize the screening force to provide the flexibility required to react to the specific situation.

**Guard.** A guard mission is assigned with the intent of protecting the force. It accomplishes all tasks of a screening force, providing the division, whether it is moving or stationary, with early warning, reaction time, and maneuver space to the front, flanks, or rear. A guard force protects the main force from enemy direct fire, observation, and surprise attack. It reconnoiters, screens, attacks, defends, and delays as required. Guard missions in a combat environment require a survivable antitank capability. Light infantry

and cavalry units lack the firepower necessary to conduct a guard mission without augmentation. Light armor units can augment these forces or, if augmented with other combined arms assets, conduct a guard mission alone.

**Cover.** A cover mission provides the main body with early warning, reaction time, maneuver space, and information about the enemy while deceiving the enemy regarding the location, size, and strength of the main body. A covering force is tactically self-contained and operates at a considerable distance to the front, flanks, or rear of a moving or stationary force. It accomplishes all tasks of screen and guard forces. Its mission is to develop the situation early and defeat the enemy's lead forces. The cover mission for a division normally requires a brigade-size force to provide adequate C2, maneuver units, CS, and CSS to accomplish the mission. It should be heavily supported by field artillery (FA), engineers, air defense, intelligence resources, and CSS. Light infantry brigades do not have the mobility and firepower to conduct a cover mission *even with* augmentation by light armor.

**Counterreconnaissance.** Counterreconnaissance is an inherent task, either active or passive in nature, conducted to thwart enemy reconnaissance and surveillance (R&S) efforts. Its purpose is to deny the enemy commander his eyes and ears, impeding his ability to determine the disposition of friendly forces. It includes combat action to destroy or repel enemy reconnaissance elements. If successfully executed, counterreconnaissance adds the element of surprise to offensive operations and prevents the rapid execution of the enemy's attack plan in the defense. Counterreconnaissance efforts are continuous and are conducted throughout the depth of the AO by all organic and supporting combat, CS, and CSS units. Light armor counterreconnaissance measures include, but are not limited to, fire and maneuver to destroy enemy forces, emplacement of obstacles to deny specific areas to the enemy, sustainment operations to maintain the counterreconnaissance effort, and effective C2 to integrate and synchronize all assets.

## BATTLEFIELD OPERATING SYSTEMS

This section describes battlefield operating systems (BOS) that light infantry and light armor units must coordinate and synchronize in all types of combat operations. The systems, however, are a planning tool to organize battle tasks, not a framework for execution or issuing orders.

**Intelligence.** Light armor employs intelligence and electronic warfare (IEW) to provide critical intelligence and to facilitate effective electronic warfare (EW) against enemy C2 systems and tactical forces. Light armor intelligence assets include organic tactical reconnaissance and security capabilities, division intelligence unit support, and EW unit support. The organic scout platoon and other units in contact, as well as the division MI battalion, provide intelligence to light armor units.

**Maneuver.** The LID uses light armor to seize and retain the initiative and to close with and destroy enemy forces in the close fight. The objective of maneuver for light armor is to place or move its combat elements into positions where they can bring direct fires to bear on the enemy. Light armor units can inflict the greatest damage on the enemy by avoiding head-on encounters and striking the vulnerable enemy flanks and rear where superior combat power can be achieved.

Maneuver also includes firepower. Light armor gives the infantry commander added firepower and lethality to integrate into all operations. It can be quickly massed for attacks and counterattacks by fire and/or maneuver.

Based on the light infantry mission, the commander allocates and positions light armor units where he can best employ their combat systems according to the terrain and expected enemy capabilities and actions. In some instances, divisions may employ light armor forces in conducting mobile combat against armored and mechanized threats. The commander must



identify the narrow windows of opportunity to maneuver light armor forces offensively and to force the enemy to halt its attack and/or change its plan.

Light armor forces may be appropriate as reserves. Their mobility and firepower allow them to strike the enemy at the critical time and place, seizing or regaining the initiative or destroying the enemy force. They can also stop sudden enemy penetrations or incursions into the rear. The division may commit light armor forces with elements of its aviation brigade in support of its deep operations. Depending on the mission, responsive artillery, engineer, intelligence, and CSS are necessary to support this operation.

**Fire Support.** FS assets are positioned to mass lethal fires throughout the depth of the battlefield. They are responsive to multiple targets and can rapidly shift priority of fires. FS is provided to light armor by its organic mortars, the division and corps FA, Army and USAF air support, and NGF. To properly execute their fire support requirements, light armor units must coordinate closely with the fire support element (FSE), the tactical air control party (TACP), and the air/naval gunfire liaison company (ANGLICO). The light armor FS plan is integrated into the scheme of maneuver consistent with the commander's intent.

**Air Defense.** Air defense assets prevent air attacks on friendly units, supplies, and facilities by identifying and destroying enemy aircraft. Light armor relies on the division's air defense weapon systems as well as on its own active and passive measures, which include camouflage, deception, and direct and indirect fire. Light division air defense systems are capable of limited protection of maneuver, CS, and CSS elements with Stinger and Avenger weapon systems.

**Mobility and Survivability.** Mobility, countermobility, and survivability operations enhance mobility for light armor units, degrade the enemy's ability to move on the battlefield, and provide protective emplacements to enhance personnel and equipment survivability. They are planned based on the commander's intent, mission, and concept of operation. The light division engineer battalion must be augmented with corps engineer assets to conduct extensive mobility, countermobility, and survivability missions.

Mobility operations include breaching friendly and enemy minefields and obstacles, crossing gaps and water obstacles, maintaining main supply route (MSR), and preparing combat trails between battle positions (BP).

Countermobility operations are combat multipliers that enhance the effects of friendly direct and indirect fires. They degrade the enemy's ability to execute its plan by disrupting combat formations, interfering with C2, and confusing enemy commanders. They provide friendly maneuver commanders with critical time and space (depth) that can be exploited by fire and maneuver. This is accomplished with an integrated system of obstacles and tires that disrupts, turns, blocks, or fixes enemy movement in support of close and rear operations. Countermobility operations create opportunities that light armor weapon systems can exploit. Commanders must ensure that obstacles support their intent, mission, and scheme of maneuver, but do not degrade their own mobility.

Survivability operations consist primarily of preparing fighting and protective positions that allow light armor to survive to fight again. Light division engineer units have limited capability to prepare armor survivability positions. NBC defensive measures also increase light armor's survivability. LID and corps chemical assets provide assistance. See Chapter 8 for information on chemical support.

**Combat Service Support.** CSS units are responsible for sustaining combat operations throughout the depth of the battlefield. They must provide supplies and other support in sufficient quantity and with enough flexibility to support the overall intent and concept of the commander. The inherent immaturity of the contingency theater makes CSS extremely difficult. In situations where strategic lift capability is insufficient to provide all the support needed, sustainment operations can succeed only through anticipation, continuity,

responsiveness, and improvisation. CSS for the light armor battalion comes from its organic support and maintenance platoons, division support units, and corps support units.

**Command and Control.** To be effective, C2 must be forward, redundant, flexible, and survivable. Command posts (CP) and communications systems are key components of C2 in light armor units. The commander uses them to obtain timely information, make responsive decisions, communicate orders, and ensure compliance with them. Effective C2 allows him to “sense” the total battlefield and adjust quickly to take advantage of enemy weakness. It also enhances the responsiveness of combat, CS, and CSS assets.

# COMMAND, CONTROL, AND COMMUNICATIONS

Command, control, and communications (C3), comprises coordinating, planning, directing, and controlling all unit activities. The C3 process serves two purposes. It gives the commander the means to communicate his intent to his staff and maneuver and support forces. It also enables staffs to quickly and effectively assist their commanders in planning and executing operations faster than the enemy can react. To be effective, C3 must be properly organized. Staffs must be well trained. Commanders and staffs must practice the C3 process so that procedures become instinctive.

## CONTENTS

	Page
Section I. Leadership . . . . .	2-2
Section II. The Planning Process. . . . .	2-2
Troop-leading Procedures . . . . .	2-2
The Command Estimate . . . . .	2-5
Abbreviated Planning . . . . .	2-8
Section III. Intelligence Preparation of the Battlefield. . . . .	2-9
Battlefield Area Evaluation . . . . .	2-10
Terrain Analysis. . . . .	2-11
Weather Analysis. . . . .	2-13
Threat Evaluation. . . . .	2-13
Threat Integration . . . . .	2-14
Section IV. Communications. . . . .	2-16
Responsibilities . . . . .	2-16
Mobile Subscriber Equipment. . . . .	2-16
Section V. Command and Control Techniques . . . . .	2-18
Orders . . . . .	2-18
Briefbacks . . . . .	2-18
Rehearsals. . . . .	2-18
Position Location Devices . . . . .	2-19
Readiness Conditions . . . . .	2-21
Section VI. Operations Security . . . . .	2-22
Countersurveillance . . . . .	2-22
Information Security . . . . .	2-24
Signal Security . . . . .	2-24
Physical Security. . . . .	2-24
Section VII. Continuous Operations. . . . .	2-24
Effects . . . . .	2-24
Key Leader Sustainment . . . . .	2-25
Unit Sustainment . . . . .	2-26

## Section I. Leadership

Leadership is a primary dynamic of combat power that affects the success of C3. In modern war, the enemy seldom conforms to expectations; defeating him demands bold and aggressive leadership. Leaders must be willing to take responsibility and use initiative, guided by their commander's intent. Leaders must be able to think clearly and quickly. Speed and decisive action are critical.

One of the keys to success of C3 is the ability of leaders at all levels to issue effective, mission-type orders. These orders must place restrictions on subordinates only to the degree that coordinated action of the command is assured. They must use terminology that is widely understood throughout the command. Above all, they must accurately communicate the commander's intent, which guides subordinate commanders in pursuit of the common goal in the absence of communications.

Light armor units are most effective when massed. However, they are often decentralized and separated by means of task organization with light infantry. This can occur down to platoon level; except for rare exceptions, platoon is the smallest light armor fighting element. In such an organization, commander-subordinate relationships must be characterized by mutual trust and respect. Commanders and subordinates must know how each other thinks. Commanders must teach subordinates not what to think, but how to think. Conversely, when armor units are decentralized and attached to light infantry, armor leaders must be assertive in advising the infantry commander and his staff on the best means for armor employment and logistical requirements. Constant communications with the armor liaison officer (LO) is paramount to ensure continuity between light and heavy forces.

## Section II. The Planning Process

To be successful, commanders must be able to make good decisions quickly. Staffs must be able to assist commanders in making those decisions and translating them into action faster than the enemy can react. Units that are able to respond quickly to changing situations will seize the initiative from the enemy and defeat it.

The planning process is a systematic approach to formulating tactical plans. Processes used are troop-leading procedures, the estimate of the situation (command estimate), the factors of METT-T, and intelligence preparation of the battlefield (IPB). These processes are interrelated. Figure 2-1 shows the flow of the planning process. The planning process is accomplished based on the time and other resources available. The following paragraphs briefly explain how the planning process is conducted. They include a discussion of commander and staff actions during troop-leading procedures. They also describe how the estimate, METT-T, and IPB are integrated into the troop-leading procedures and how they may differ for light armor units.

### TROOP-LEADING PROCEDURES

Troop-leading procedures are a continuous process. There are no distinct start and stop points. Steps are not independent; several can occur simultaneously. Troop-leading procedures apply to all levels of command. They can be adjusted to fit any tactical situation. For example, the less time a unit has, the more it must abbreviate the procedures.

The collection, analysis, and distribution of information is a continuous staff requirement. Information analyzed by a staff section is exchanged with other staff sections and used to update the situation. Periodic staff huddles are useful to successfully execute the mission, the staff must focus on the information the commander needs.

Troop-leading procedures provide a systematic approach for making decisions and a framework for organizing action upon receipt of a new mission. This section will not discuss troop-leading procedures in detail; they are described more thoroughly in numerous references, such as FM 71-2.

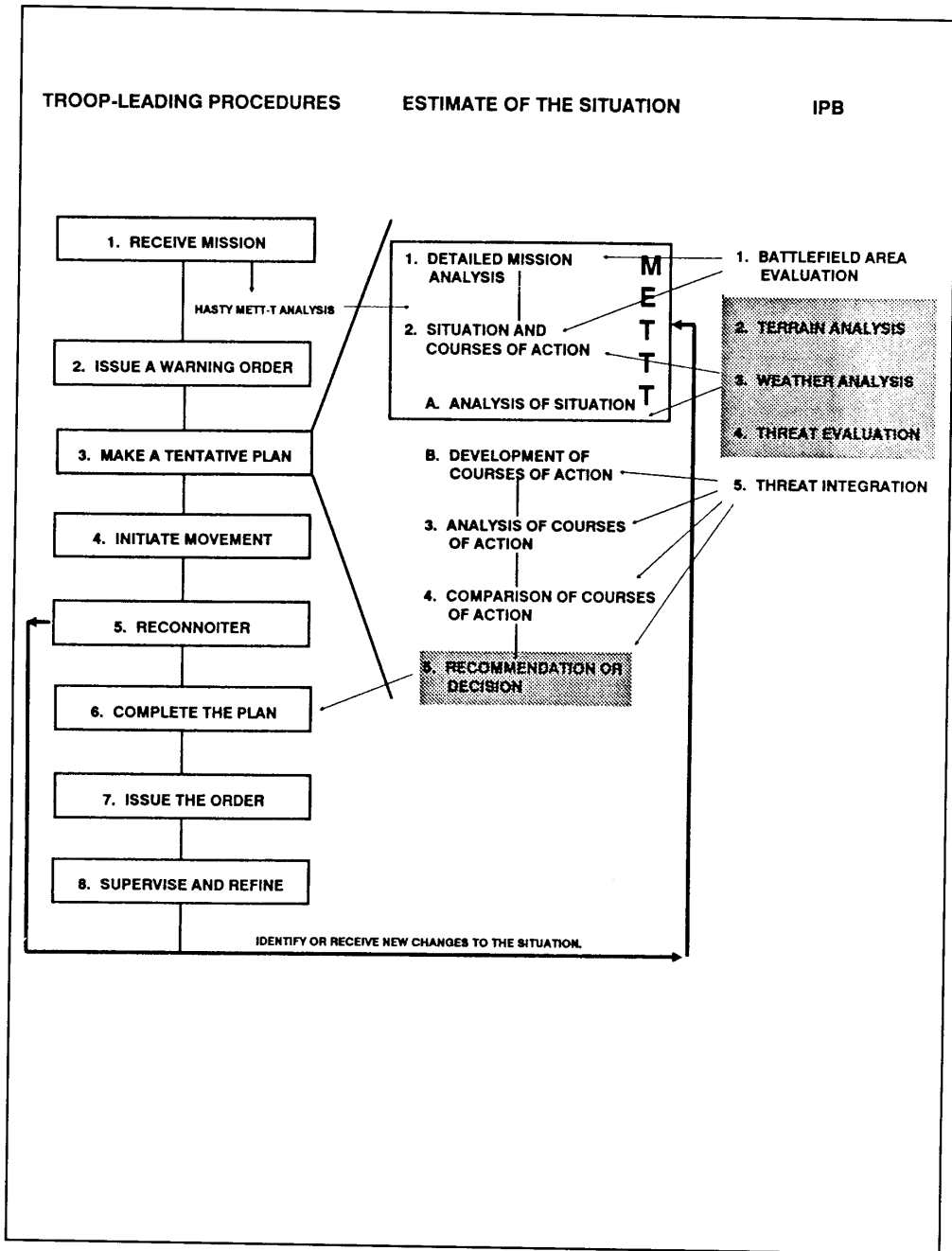

Figure 2-1. Integration of troop-leading procedures, command estimate, METT-T analysis, and intelligence preparation of the battlefield.

**Application of Troop-leading Procedures.** Troop-leading procedures are used at all echelons of command. This discussion will provide light armor commanders and staffs with an explanation of the processes involved in planning. The application of troop-leading procedures in practice will vary with each different situation.

Company commanders will not have the time to perform all the steps of the planning process. They cannot produce a detailed IPB product. They will have to visualize the elements of the IPB that relate to their battle space. This includes identifying enemy avenues of approach (including air and dead space), reconnoitering as far forward as possible, and viewing the AO from the enemy's perspective. Company commanders should not hesitate to seek assistance from the battalion staff. Ten to 15 minutes of staff coordination can avoid much wasted time and effort. Company commanders can also receive assistance during planning from their executive officers (XO), first sergeants (ISG), and fire support team (FIST) chiefs.

**Backward Planning.** One of the first steps in troop-leading procedures is to plan the use of available time. Backward planning is one such technique. It is used to develop an informal schedule, starting with the execution time in the mission statement and listing activities in reverse order back to the current time. The schedule should ensure that the commander and staff consume no more than one-third of the available time to prepare and issue orders to subordinate commanders. Using a preprinted form listing normal activities is a technique that commanders may use to make their schedules. The light armor battalion commander may use a preprinted timeline form for planning (see Figure 2-2).

LIGHT DATA	TIME	EVENT	TIME	TASKS TO BE COMPLETED
<div style="border: 1px solid black; width: 50px; height: 100%;"></div>	_____	Received Mission	_____	Situation Update Brief
			_____	Mission Analysis/Restated Mission
			_____	Warning Order Sent
			_____	Receive Cdr's Planning Guidance
			_____	Develop Estimates and War Game
			_____	Conduct Reconnaissance:
				-Position TRPs
				-Identify Battle Positions
	_____	BRIGADE OPORD	_____	Complete COA Analysis
			_____	COA Decision Brief:
				-War Game with Commander
				-DST Drafted
			_____	OPORD Preparation:
				-Finalize Scheme of Maneuver
				-Prepare/Wend IVIS Overlay
			-Initiate Reproduction	
		_____	Begin Pre-Positioning Class V	

Figure 2-2. Example of a backward planning timeline (defense).

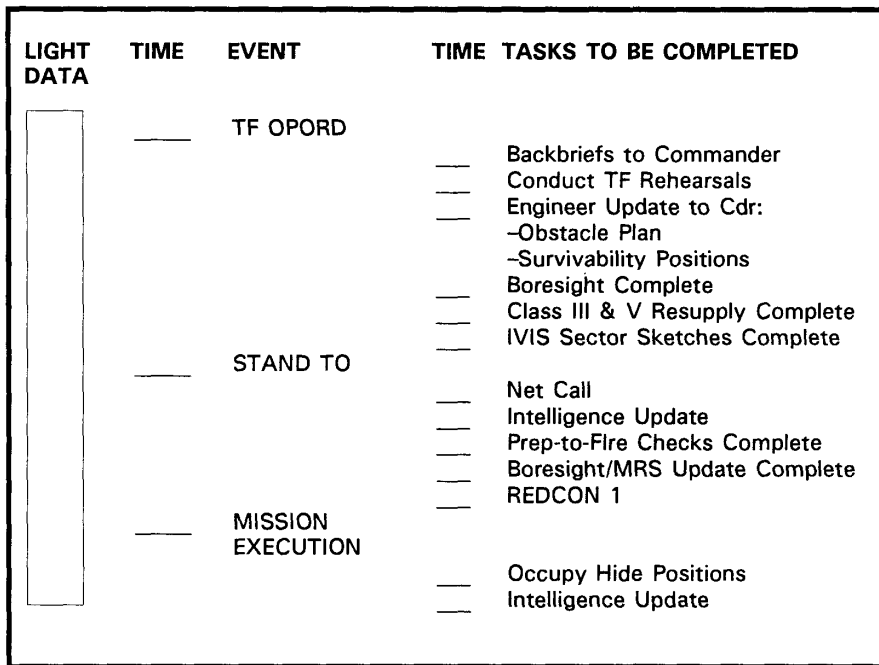

Figure 2-2. Example of a backward planning timeline (defense) (Cont).

## THE COMMAND ESTIMATE

The command estimate is an integral part of troop-leading procedures. It is the logical thought process to assist the commander with formulation of tactical decisions at any level. The Army developed the command estimate process to preclude planning procedures that require an inordinate expenditure of time or adherence to a rigid structure. See Figure 2-3 for a summary of the command estimate. FM 101-5 contains a detailed description of the command estimate.

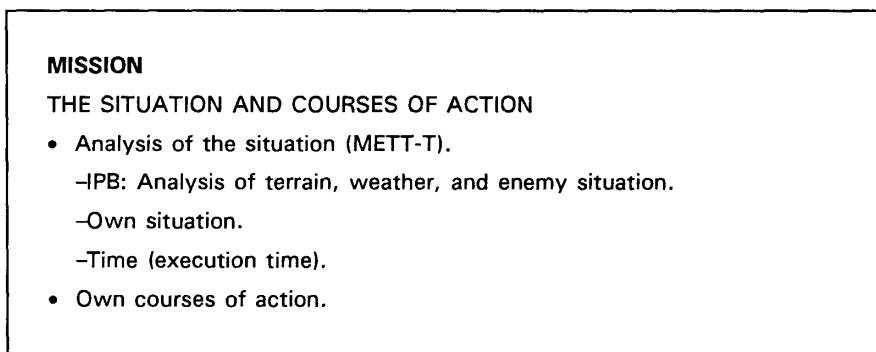

Figure 2-3. Command estimate.

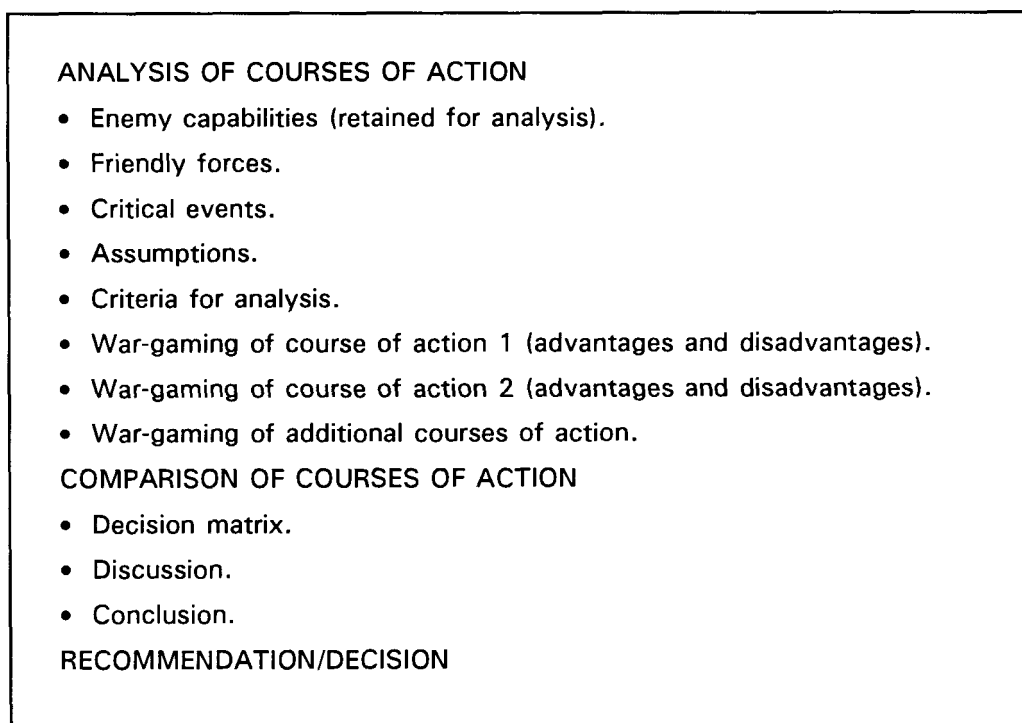

Figure 2-3. Command estimate (Cont).

**Staff Input.** The battalion staff provides information to the commander and operations and training officer (S3) to help in their command estimate process. Refer to appropriate doctrinal manuals for additional information on specific staff responsibilities in the estimate process.

**Command Estimate Checklist.** The command estimate checklist consists of the following elements:

- Receive the mission.
  - Issue warning order (WO).
  - Alert staff.
  - Time appreciation.
- Analyze the mission.
  - Intent of higher commander.
  - Intent of commander two levels up.
  - Review of AO to understand higher mission and intent.
  - Tasks to be performed (specified, implied, and essential).
  - Constraints (what must be done).
  - Restraints (what can be done).
  - Acceptable level of risk (time, space, and forces).
  - Restated mission.



- Issue guidance to staff.
  - Restated mission.
  - COA to consider or not to consider.
  - Time schedule.
  - Changes required to current task organization.
  - Movement instructions.
  - Reconnaissance and security instructions.
- Analyze the situation.
  - IPB (S2).
    - +Current enemy situation.
    - +Enemy capabilities and COA.
    - +Named areas of interest (NAI) and timelines.
    - +Exploitable enemy weaknesses.
  - Own situation (S1, S3, S4).
    - +Current.
    - +Projected.
- Develop alternative COA (S3).
  - Forces required based on the evaluation of enemy units, avenues of approach, objectives, and any other factors affecting force ratios, such as surprise, terrain, or flank positions.
  - Locations to engage enemy (target areas of interest [TAI] ), attack (line of departure [LD] and axes), and defend from BPs.
  - Array forces (two levels down).
    - +Main body.
    - +Reconnaissance/security (covering NAI and decision points [DP] ).
  - Scheme of maneuver.
  - Allocate subordinate headquarters.
- Analyze (war-game) COA (S3).
  - Identify critical events.
  - War-game.
    - +All plausible enemy COA.
    - +Action, reaction, and counteraction.
- Compare COA, including advantages versus disadvantages of each (S3).
- Decide on COA and inform staff and subordinate elements.
  - Base decision on staff recommendations (S2, S3, and S4).
  - Issue decision as concept of operations.
  - Issue further planning guidance.
  - Issue updated WO.
  - Issue fragmentary order (FRAGO) or operation order (OPORD).

## ABBREVIATED PLANNING

**Hasty Planning.** Hasty planning will be the norm after hostilities are initiated. The focus during the abbreviated planning process is time management and concurrent actions. Once the battalion staff has a thorough understanding of the formal command estimate process, it can conduct more efficient hasty command estimates. Hasty planning is situational; proficiency comes through practice. The XO runs the planning effort while the light armor battalion is in contact.

Once deployed into a tactical situation, the light armor unit will have limited time available to plan for a mission. A checklist for hasty command estimates that can be used by the battalion commander and staff is shown in Figure 2-4.

**Tactical Contingency Planning.** Commanders may identify contingency missions during the planning process, especially if the unit is in reserve. When faced with several possible missions, commanders should consider all critical tasks for each contingency. The following is a sample checklist for considering the critical aspects of a counterattack mission:

- Target array.
- EAs.
- Direction of attack into target.
- Routes.
- Alternate routes.
- FS C2.
- Air defense artillery (ADA) to prevent interdiction.
- Mobility plan for enemy family of scatterable mines (FASCAM).
- Passage of lines coordination.
- Cue to launch.

Units often have on-order and follow-on missions. Commanders should identify, plan, and coordinate critical tasks of these missions while planning for the primary or first mission.

Hasty Command Estimate - Checklist. When planning time is too short, the commander must abbreviate the process even more. The sample checklist below can be used by the commander and staff to develop the abbreviated estimate.

- Mission receipt (same).
- Mission analysis.
  - Intent of higher commander.
  - Intent of commander two levels up.
  - Essential tasks to be performed.
  - Restated mission.

Figure 2-4. Hasty command estimate - checklist.

- Initial guidance to staff.
  - Movement instructions.
  - Reconnaissance and security instructions.
  - Updated WO.
- Situation.
  - Current enemy situation (intelligence map).
  - Current friendly situation (operations map).
  - Deductions.
- COA (while looking at ground or operations map).
  - Locations to engage enemy.
  - Scheme of maneuver.
- Analysis of COA (using basic criteria such as time, simplicity, and effectiveness).
- Issue decision as concept of operations.
- Issue FRAGO.

Figure 2-4. Hasty command estimate - checklist (Cont).

### Section III. Intelligence Preparation of the Battlefield

IPB is a systematic and continuous process of analyzing the enemy, weather, and terrain in a specific geographical area. The IPB process integrates enemy doctrine with weather and terrain to determine how the weather and terrain will influence the enemy's fight.

IPB is an extremely important aspect of preparing intelligence for the commander. It is integral to the command estimate, as illustrated in Figure 2-1. Faced with large AOs, a limited number of maneuver units, and finite collection assets, the commander must rely on IPB to provide his focus in operations other than war. IPB must be continuously updated for the commander to act quickly and decisively.

The commander and all members of the staff participate in the IPB process. The S2 must determine, as closely as possible, the locations of insurgent elements to allow the commander the flexibility to act immediately against the enemy. The S3 uses the IPB to analyze the enemy, terrain, and weather in his estimate. He must know the IPB process. He must also evaluate the quality of the S2's input. The S1 and S4 use the IPB to determine the impact of enemy, terrain, and weather on personnel and logistical operations. The CS staff uses the IPB in a similar manner for their areas.

Since light armor units may become involved in contingencies worldwide, it is difficult for the S2 to have prepared analysis already completed for each possible area. The S2 must start the IPB process as early as possible. As "hot spots" flair up in the world, the S2 can review current OPLANs and begin terrain, weather, and threat analysis as a precaution. This allows him to update the information if the unit is alerted for deployment. Early identification of the AO will enable the S2 to start the terrain analysis. As a minimum, the situation template should be finished when the S3 begins his analysis of the situation.

IPB is a useful aid to planning. There is a tendency, however, to believe all assumptions made in IPB are true and to develop plans accordingly. This is dangerous because it could make friendly forces susceptible to surprise by the enemy. Commanders and staffs must be aware of this possibility. They must develop plans to prevent the command from being surprised by unexpected enemy actions. Some of the techniques provided in the following discussion will assist staffs at the battalion level in performing IPB.

A modified form of IPB is required to provide the commander with the intelligence estimate in operations other than war. These modifications stem from three critical factors inherent to most situations:

- The nature of the threat.
- The importance and welfare of the civilian population.
- The role of the host-nation government and military.

In operations other than war, insurgent forces will blend with the population. They will use a variety of tactics and levels of violence to accomplish their goals, including propaganda, terrorism, guerrilla tactics, and crime. While generic organizational categories and strategies have been identified, insurgents seldom conform to a common doctrine in operations other than war. IPB must be based on the specific situation and geographic area of concern.

Constant awareness of the population factor is critical to the long-term success or failure of operations other than war. Insurgency or counterinsurgency will involve combat, CS, and CSS operations near or among host-nation civilians. A primary objective of these operations will be to protect and secure the population and to separate them physically or psychologically from the insurgent. Such security and separation effort may be required continuously. They may place heavy constraints on the indiscriminate use of weapons and require carefully managed use of force. Key to planning in operations other than war is extensive analysis of all aspects of the civilian population during IPB, as well as IEW target development. The use of these procedures reduces the need for indirect fire or air-delivered weapons in favor of proactive intelligence operations and small unit direct action.

Ultimate success in operations other than war lies with the host nation. Host-nation civil and military authorities will primarily be responsible for military operations, civil affairs, PSYOP, and population resource control. US forces ideally should avoid these tasks, but may be required to provide advice or backup. Knowledge of the host nation's military tactics, operations, and intelligence functions, as well as its capabilities and limitations, are critical in effective integration of US military forces.

The five functions of the IPB process are battlefield area evaluation, terrain analysis, weather analysis, threat evaluation, and threat integration. As currently used for conventional conflict planning, these functions allow for effective integration, with some modifications, of the factors unique to operations other than war. The following discussion provides a step-by-step examination of considerations that may apply when light armor units are deployed in a nonconventional role.

## **BATTLEFIELD AREA EVALUATION**

Results of battlefield area evaluation are recorded on Overlay #1, the combined obstacles overlay. The overlay accomplishes the following:

- It identifies the AO. In all operations, including those other than war, the AOs are geographical areas designated by the next higher headquarters. They represent the areas where the commander has the authority and responsibility to conduct operations.

- It identifies the area of interest. This is determined by the commander on the recommendation of the S2. It contains enemy forces that could affect future operations. In the absence of guidance from the commander, make the area of interest at least half again the size of the AO.
- It identifies other considerations in battlefield area evaluation. Both AOs and interest are analyzed based on METT-T; in operations other than war, however, an evaluation of both areas as to host-nation civilian or military activity is also critical.

## TERRAIN ANALYSIS

Special products and detailed terrain analysis information can be provided by corps or division terrain teams for use in light armor units. Information developed from the terrain analysis is recorded on Overlay #1, the combined obstacles overlay. This analysis is based on the five military aspects of terrain (the sequence may vary according to the way IPB is developed):

- Obstacles.
- Cover and concealment.
- Observation and fields of fire.
- Key terrain.
- Avenues of approach.

The following paragraphs provide a detailed discussion of the information and considerations that are part of the terrain analysis process as it relates to operations other than war.

Because insurgent forces are generally fewer in number than counterinsurgent forces and lack sophisticated logistics, they normally avoid positional warfare. They usually avoid seizing, controlling, or defending conventionally defined “key terrain.” Also, rapid movement across difficult terrain is one of the insurgent’s major assets. Therefore, traditional combined obstacles overlays have limited bearing on analysis of threat movement. To insurgents, the most important aspects of terrain are those that provide logistics support and security.

The population is often the dominant factor in operations other than war. The population can provide both support and security to the insurgent and represents the only key “terrain feature” which must be “seized,” “controlled,” or “defended.” With the proper information and collection effort, the S2 can begin classifying the population in the battlefield area into logical groups (tribal, religious, ethnic, or political). Their affinities and loyalties must be evaluated, maintained, and updated. The S2 normally relies on higher headquarters and the host nation for this type of information.

Although the definition of key terrain remains the same in operations other than war as in other military operations, considerations involved in selecting key terrain differ significantly in counterinsurgent operations. In conventional operations, such factors as characteristics of the local population and the logistical resources of the area play little or no part in selecting key terrain. In fact, such aspects of the AO normally are considered by the S2 after he selects key terrain. Counterinsurgent operations may be rural or urban in nature, and determination of “key” terrain within the overall area will be influenced considerably by these other characteristics. Knowledge of these factors as they affect the use of the AO by both the friendly and enemy forces is essential for selecting key terrain. Examples include the following:

- A village or town that has no tactical significance, but has psychological or political significance as a provincial or district seat of government.

## FM 17-18

- Coffee, rice, or other crop fields, especially during the harvest season. These may have little tactical significance, but are extremely important to the livelihood of the civil population.
- Sources of food. If the guerrilla force is known to have a critical shortage of food, any source of food within the AO, such as a market or rice storage facility, may become key terrain.
- Drugs. In drug-producing areas, these may be key areas because of their economic value to guerrillas.
- Lines of communication. Trails and roads frequently become key terrain in areas such as the jungle and high mountains because they may be the enemy's only armored avenue of approach.
- Sources of medical supplies. Guerrilla forces frequently face serious shortages of medical supplies; therefore, any area or outlet where such supplies can be obtained may be key terrain.

An overlay may also be prepared to identify insurgent logistical sustainability, including populations providing water and food for guerrilla forces or areas that, because of their location, provide easy access to such supplies. The combination of overlays for population status and logistical sustainability can identify areas from which insurgents are likely to operate. Areas with a high probability of supporting insurgents include those that provide cover and concealment, a friendly or neutral population, and ready access to supplies. These areas can become NAI for further intelligence collection to confirm or deny an insurgent presence in the area and, considered with other indicators, to determine its intentions. Where areas of potential population or logistical support are separated from areas of cover and concealment, insurgents may move between the two.

Two other overlays that may be prepared during the terrain analysis process are the trap overlay and the road and trail overlay. The trap overlay identifies targets that insurgents may find attractive to sabotage or attack. These may include bridges, power stations and transmission lines, sites that favor ambushes, or even likely kidnap targets. Such areas are marked on the map with attention directed to possible insurgent access and escape routes. The trap overlay may be combined with the logistical sustainability overlay. The road and trail overlay gives special attention to lines of communication that are in potential insurgent areas, that support a potential insurgent area, or that are new. Many times, aerial imagery can reveal new trails.

Avenues of approach are identified, as in other operations, as a result of consideration of the other military aspects of terrain. In other operations, however, the key consideration for avenues of approach is adequate maneuver space; guerrilla and counterinsurgent operations have peculiarities that require a departure from normal considerations. Historically, most guerrilla activities in operations other than war have been small-unit actions involving company-size and smaller units. The intelligence process must identify and analyze smaller avenues of approach into areas and installations defended by friendly units. No avenue of approach should be disregarded simply because the terrain appears impassable. In fact, avenues of approach over difficult and seemingly impassable terrain normally offer the counterinsurgent force its greatest opportunity for achieving surprise. General avenues of approach can sometimes be identified by studying the population status overlay. In many cases, personnel or supplies will move through areas where the population is sympathetic to the insurgents.

## WEATHER ANALYSIS

The same weather considerations and overlays generally will apply in operations other than war as in other operations. For example, weather effects on observation and fields of fire, camouflage, landing zones (LZ), and line-of-sight radio/radar equipment still apply.

A thorough knowledge of climatic conditions, as well as the usual evaluation of short-duration weather forecasts is essential to the accurate determination of the effects of weather on the unit mission. In areas of great seasonal climatic change, terrain intelligence produced during one season may be practically useless in other seasons. Therefore, climatic weather and terrain intelligence must be continuously produced and reviewed to ensure it is applicable.

Guerrilla and counterinsurgency tactics involve frequent combat action at extremely short ranges; knowledge of the effect of the weather and natural illumination on visibility is critical for planning and conduct of operations. The exact visibility conditions at specific times of day in specific types of terrain must be determined. To confirm the estimate of the effect of the weather on visibility, personal reconnaissance may be required, particularly during the periods of limited visibility.

Mobility is essential to both guerrilla and counterinsurgency offensive operations. Therefore, knowledge of the effects of the weather on trafficability will have great bearing on the timing and nature of operations. Normally, rural guerrillas will rely primarily on walking, small watercraft, and animal transport; this means the effects of the weather on trafficability and on air and amphibious mobility are usually of significance to the counterinsurgency force. Although adverse weather conditions will frequently hinder the counterinsurgency force more than its guerrilla enemy, the flooding of rivers and streams and the creation or intensification of swamps and marshes seriously reduce the guerrilla's ability to withdraw. Other weather considerations include the following:

- Guerrillas will normally use bad weather or hours of darkness to their tactical advantage. These conditions reduce the effectiveness of observation, direct fire, air support, and artillery employed by the counterinsurgency force.
- Weather can affect the availability of food supplies, such as crops and livestock.
- It is more difficult for insurgents to cache supplies in frequently flooded areas.
- Mass demonstrations are planned for predicted periods of good weather to ensure maximum turnout.
- Civil affairs projects and PSYOP media may be degraded by bad weather.
- Bad weather will degrade the already poor road networks common in many active insurgent areas.

## THREAT EVALUATION

Threat evaluation for operations other than war must begin early and cover a wide range of factors. These factors include all aspects of the leadership, objectives, organization, tactics, external support, timing, and environment related to the insurgency. Doctrinal templates and decision support templates are also used during operations other than war (refer to FM 34-7 and FM 34-130 for additional information). This does not mean insurgents operate without tactical doctrine; it means their tactics do not lend themselves to doctrinal templates. Despite the lack of insurgent doctrine that can be templated, every effort should be made during the threat evaluation to identify the insurgents' patterns of operations and tactics and to identify specific targets that can be further analyzed and exploited during threat integration.

Guerrilla tactics are usually characterized by small-scale operations conducted over an extensive area, hit-and-run offensive techniques, withdrawal, and dispersion. Guerrilla forces, like any other enemy, have the general capabilities of attacking, defending, withdrawing, and reinforcing; however, these capabilities are implemented in ways and by means that differ from those encountered in conventional warfare. Threat evaluation must take this factor into account.

The first step in understanding the guerrilla is to make a thorough, detailed study of guerrilla organization and tactics in general, as well as those of the particular guerrilla against which the division will be engaged. This information must be understood by all levels of command. As in conventional warfare, the effectiveness of the intelligence planning, the focus of the collection effort, the processing of information, and the use of the resulting intelligence in the estimate all depend on the degree of familiarity with the enemy's tactics and techniques.

Guerrilla forces may be accounted for in terms of recognized military units (such as squads, sections, or platoons) if their organizational structure is known and if such accounting provides meaningful information for the commander and other members of the staff. If not, guerrilla strength may be accounted for in terms of total numbers or in numbers of units of a particular strength. All crew-served weapons known to be available to support the guerrilla forces are accounted for individually.

After collecting the available information on the guerrillas, the S2 evaluates what the enemy is capable of doing. Among the capabilities to be judged are whether or not the insurgent is capable of—

- Conducting sabotage and, if so, to what extent.
- Attacking defended positions.
- Employing indirect-fire support.
- Directly engaging government forces.
- Collecting intelligence.
- Using mines and booby traps.

The insurgent situation overlay is prepared during this portion of the IPB. This overlay includes all the relatively pertinent information available on the insurgent, such as urban and rural insurgent camp locations, unit operating areas or boundaries, and trails. This map is kept current as the insurgent moves and his capabilities change.

## THREAT INTEGRATION

Threat integration relates enemy doctrine to the terrain, weather, and population to determine when and where the insurgent may conduct operations in support of its objectives. Generally, information for the situational template is gathered after the unit arrives on the scene. This is where the situational template for operations other than war varies from that of conventional IPB. Since there is no doctrinal template for IPB in operations other than war, the situational template is based not on formations and how the enemy moves, but on types of activity, when and where they will occur, and where guerrillas will have to be for them to occur. The template is also based on knowledge of the insurgent's capabilities and trends that show where and how it operates.

The first step is to identify the significant action or series of actions (mission) the insurgent may want to carry out. For example, will he carry out a direct attack against a defended town? Will he attempt to isolate a town or region? Will he attempt to disable the region's economy? Will he use sabotage to carry out his objectives?



Each insurgent mission requires different types of weapons, training, and tactics. A long-term, serious attempt to disable an area's economy by sabotage would require additional training and explosives (the friendly S2 would determine likely sabotage targets). If insurgents tried to directly attack, not harass, a defended town, they would need a more conventional military organization, better communications, advanced supply caches, and perhaps indirect-fire weapons. They also might require extensive intelligence-gathering capability to attempt such an operation.

A situational template to analyze possible significant insurgent attacks against a defended point requires at least the following:

- Ambush points on friendly avenues of approach into the area.
- Possible assault position(s).
- Possible locations of mortars within range of the target.
- Insurgent routes into assault positions or vicinity targets.
- Insurgent escape routes after the attack.

Insurgent activities that may foreshadow such an attack include the following:

- Increased caching of supplies.
- Increased insurgent movement.
- Increased sightings of insurgents in the area.
- Reoccupation or reverification of established camps within a one-to-two day march of the target.

In preparing a situational template for insurgent capabilities, remember that an insurgent many times will carry out multiple types of activity within a given area. The S2 must perform a pattern analysis to identify the emphasis. Situational templating provides the basis for event templating. Identification and analysis of significant battlefield events and enemy activity will provide indicators of probable enemy COA. NAI are identified through terrain analysis and situational templating. By combining information on cover and concealment, logistical support, and population status, the intelligence officer (S2) can identify potential insurgent camp areas, which are also NAI.

TAI, which are based on the NAI, will be important. For example, a light armor unit moving along a road will already have potential ambush points identified as NAI. These points were previously targeted by collection assets before and during movement. They have also been coordinated by the S2 as TAI with the fire support officer (FSO) and the S3. If potential insurgent activity is identified within the TAI, the commander can decide how to deal with it. However, care must be taken to confirm that it is insurgent activity and not civilian-related.

Target-value analysis (TVA) is also accomplished during this phase to identify high-value targets (HVT), including CPs and logistics elements. An evaluation of specific insurgent capabilities is directly related to the identification of specific HVTs. For example, if the sabotage threat is high, an HVT might be the location of explosives or an area where sabotage training is being conducted. Individuals can also be HVTs. This includes individuals whose death or capture would significantly degrade the insurgent group's leadership, espionage, population control, or operational capabilities.

## Section IV. Communications

Communications are the means through which C3 is exercised. The chain of command and succession of command must be known throughout the organization. There must be open lines of communications up, down, and laterally. Leaders should use the following guidelines in planning and executing unit communications:

- Provide for redundancy in means of communications. When possible, have a backup means at key locations.
- Ensure communications checks have been conducted prior to starting an operation.
- Send all necessary spot report information the first time.
- Ensure the net control station (NCS) enforces radio discipline continuously. This will reduce unnecessary transmissions.
- Ensure subordinates know what to do during interruptions in communications. Ensure SOPs specify immediate actions in case of jamming. This should include code words and prearranged alternate frequencies.
- Avoid overloading the communications systems. Use them only when absolutely necessary. Practice disciplined communications procedures by eliminating nonessential conversations.
- Minimize the use of radios to reduce wear and tear. This will eliminate many maintenance problems and help to ensure that radios are ready to use when they are needed.
- Pay particular attention to maintaining effective lateral communications.

### RESPONSIBILITIES

Responsibilities for communications are as follows: senior to subordinate, supporting to supported, reinforcing to reinforced, passing to passed (for forward passage of lines), passed to passing (for rearward passage of lines), left to right, and rearward to forward. All units must take prompt action to restore lost communications. Light armor leaders must have direct communications with the infantry headquarters to which they are attached and with any light infantry maneuver elements operating with them. These responsibilities also apply to the establishment of liaison between headquarters.

### MOBILE SUBSCRIBER EQUIPMENT

Mobile subscriber equipment (MSE) provides secure long-range communications within the division or corps AO. Several types of facilities provide communications links:

- Node center (NC) provides switch, radio relay, and landline transmission equipment.
- Large extension nodes (LEN) provide access and switching capabilities for wire subscribers.
- Small extension nodes (SEN) also provide access and switching capabilities for wire subscribers.
- Radio access units (RAU) provide access for mobile subscribers.

**Terminals.** Stations within the division use the MSE system via one of several types of terminals:

- Digital nonsecure voice terminals (DNVT) are telephones that hook up to the MSE system by wire.
- Digital subscriber voice terminals (DSVT) are secure telephones used with the mobile subscriber radio terminal (MSRT).
- The MSRT is a radio and a DSVT that provides access to MSE for those subscribers who cannot hook in by wire.
- FAX terminals can send or receive graphics and digital traffic. They must use a DSVT or DNVT to gain access to the MSE system.

MSE Support to the Battalion. The LID has one or two NCs. These nodes are deployed throughout the division area, forming a network that provides area support to all units with MSE terminals. The light armor battalion has no organic NCs, LENS, or SENs. Since the battalion normally occupies positions throughout the division AO, MSE nodes positioned to provide area support to divisional units will be in range of most of the light armor headquarters positions. The battalion signal officer (SO) and XO must give special attention to coordinating division MSE support for current and future operational needs. The division provides MSE support to the light armor battalion using the division signal battalion to position NCs, SENs, and RAUs.

**MSE System Layout.** Figure 2-5 illustrates the relationships among the various facilities and terminals in the MSE system.

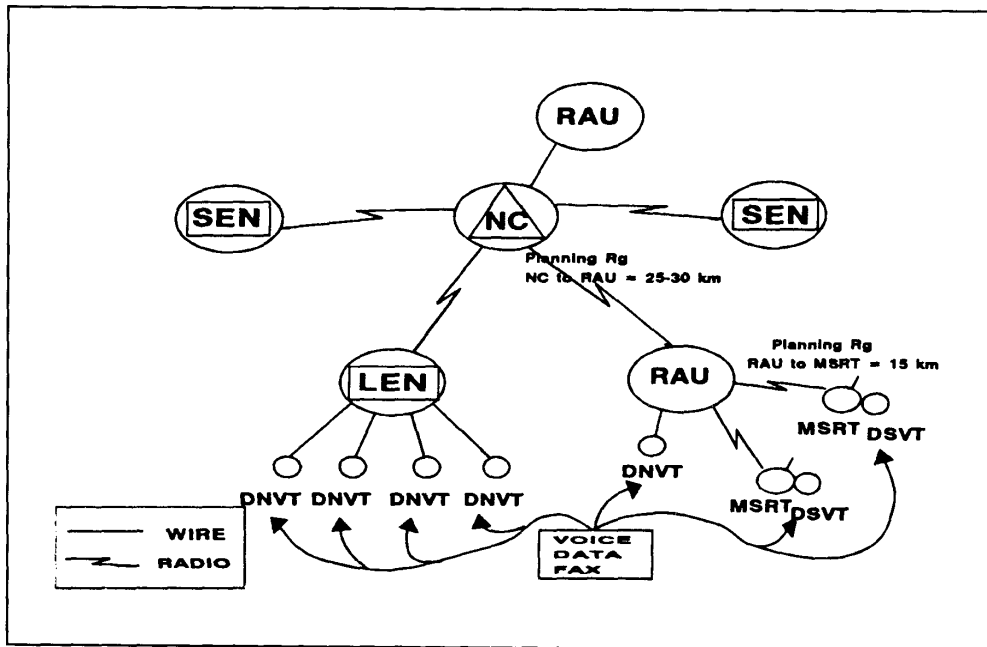

Figure 2-5. Mobile subscriber equipment system.

## Section V. Command and Control Techniques

### ORDERS

The success of an order should be measured against whether the mission fulfilled the commander's intent and not whether the order was executed to the letter. The format of an order must be commensurate with the situation.

Commanders will issue a written OPORD at the start of an operation. On offensive missions, he may issue a stand-alone overlay and rely on battle plays, drills, and subordinate initiative. On defensive missions, where he can shape the battlefield, he normally issues an overlay with execution matrix. During missions, he issues mission order FRAGOs by radio or by using the face-to-face technique.

Mission-type orders are a type of FRAGO that commanders use when the situation requires rapid mission change and immediate maneuver. A mission-type order contains a task and a purpose for the task. The task tells the subordinate commander what he is to do, and the purpose tells him why his commander wants him to do it. The commander tells the subordinate commander the purpose of the task so the subordinate commander can use his initiative to take necessary actions to ensure mission success. Refer to FM 101-5-1 for further information on orders.

### BRIEFBACKS

The briefback technique is used by commanders to ensure subordinate commanders and leaders understand the concept and intent of the operation. The briefback takes place immediately after an orders briefing. The subordinate commander must be able to discuss his understanding of—

- The commander's intent two levels up.
- The mission and intent of the higher commander.
- The main effort.
- Essential tasks.
- How his unit supports the commander's intent.

The commander may decide to have his subordinate leaders brief selected points only because of lack of time.

### REHEARSALS

Commanders and staffs at all levels should conduct rehearsals as part of troop-leading procedures if time is available. Commanders should include rehearsal plans in coordinating instructions of WOs (if possible), FRAGOs, or OPORDs. Rehearsals are not limited to maneuver elements of the TF. CS and CSS staff officers and their units may also conduct rehearsals of activities that affect the operation, such as LOGPAC organization or vehicle/casualty recovery.

When time does not permit a complete rehearsal of all critical events of an operation, the unit should, as a minimum, rehearse—

- Actions on the objective.
- Hasty breaches.
- Hasty attacks (actions on contact) or counterattacks.
- Passage of lines.

The following paragraphs discuss the various types of rehearsals.

**Backbrief.** The backbrief takes place after the subordinate commander has completed his own planning, but before he issues his own OPORD. The higher commander should tell the staff and subordinates in his OPORD when and where the backbriefs will take place. From the backbrief, the commander learns details of the subordinate's plan as well as how he plans to accomplish the commander's intent. He should plan to conduct backbriefs regardless of which rehearsal may be used later. If time does not permit other rehearsals, the backbrief may be the only rehearsal.

Generally, the backbrief will include—

- The subordinate commander's mission statement
- His concept of the operation.
- His intent.
- Planned reactions to the enemy and other anticipated contingencies.
- Assistance or coordination needed from the higher commander, staff, supporting units, or adjacent units.

Ideally, the backbrief should take place at a vantage point that overlooks the terrain with all of the key leaders and staff present. The commander may conduct a battalion backbrief at one of the company's positions center of sector where all of the other positions are visible, or he may choose to receive backbriefs as he visits each subordinate unit's position. The S3 can conduct backbriefs concurrently to save time.

**Full.** All units move over actual terrain in limited visibility and simulated NBC conditions.

**Scaled.** All units move over actual terrain.

**Leaders Only.** Leaders move over actual terrain in their vehicles or aircraft.

NOTE: If the actual terrain of the operation is unavailable, full, scaled, and leaders-only rehearsals can be conducted on terrain that is similar to the AO.

**Command Post Exercise (CPX).** CPX rehearsals are conducted by radio.

**Terrain Model.** Depending on the amounts of time, space, and resources available, several types of terrain models can be used to stage rehearsals:

- Table-mounted models showing buildings, terrain relief, and vegetation.
- Ground models using dirt, rocks, and grass to show terrain.
- Sketches on butcher paper or on the side of a vehicle.

**Walk-through.** A walk-through is conducted using a ground terrain model of fairly large scale; it can be either outside or inside. Graphic control measures are represented by engineer tape. Leaders literally walk across the zone or sector, imitating how they will maneuver while explaining what happens at each critical point.

**Talk-though.** Subordinate commanders and key staff members move stickers representing units on an operations map.

## POSITION LOCATION DEVICES

Position location systems are an aid to navigation and should not take the place of map and compass navigation. Leaders must continue to use map and compass as a primary means in the event position location system signals are interrupted by interference from vegetation, weather, or other masking features. There may also be times when satellites or land-based emitters are inoperative, causing lapses in signals.

**Characteristics of Position Location Devices.** Several types of position location systems are available to receive signals from satellites or land-based emitters and then calculate and display the position of the user in military grid coordinates and/or latitude/longitude degrees. Some of the techniques described here refer to specific features that most devices will have. Some devices, however, may not be capable of all of the functions described.

**Waypoints.** The navigational functions of position location systems are based on waypoints. A waypoint is a known position entered into the system's memory by the user. Waypoints can be entered either as degrees of latitude and longitude or as military grid coordinates. The user can either enter waypoints or store the unit's position at various times.

**Navigation.** Position location systems can be used to assist in navigation. To navigate, identify points along your route you wish to cross or at your destination. Next, enter these points as waypoints. You can then move from waypoint to waypoint and arrive at your final destination with great accuracy. Distance and direction (range and bearing) between two known points will be accurate only if they are first entered as waypoints. The system will store your present position and then compute the distance and direction to the known point. When you are ready to start your movement, get the range and bearing to the first waypoint. As you approach within a given distance of the waypoint, an alarm will sound, indicating that you have reached the waypoint. Display the range and bearing to the next waypoint.

**Cross-country Navigation.** When navigating cross country, the system will direct movement from point to point. However, obstacles en route may force detours from time to time. For detours of more than a few meters, the system can assist you in getting back on track. Some systems will display the distance you are off course, a new course to the waypoint, and an estimated arrival time based on your speed for the last two minutes. A left or right arrow shows the direction to the original track and a new bearing to the waypoint. If you need to reach the desired point and the route taken is of little importance, then you have merely to follow the ideated course. The course shown is the new direction to the waypoint and will NOT return you to the original path. If you must return to the original path, you will turn in the direction of the arrow and travel the indicated distance until the system shows a correct reading.

**Road March.** Position location systems can be useful on road marches in identifying checkpoints or coordination points on long routes that lack distinctive features. You enter a waypoint for the position of the checkpoint, select the range and bearing display to the waypoint, and drive until the alarm sounds. In this case, the bearing to the waypoint will be of little use since you will be following a road and can expect to make numerous deviations from the straight-line bearing. If you are entering a road at an unknown point, the bearing will provide a quick way to determine if you need to turn left or right to get to the waypoint.

**Uses in Offensive Operations.** Position location devices can provide valuable assistance in a variety of situations during offensive operations, including the following:

- **Assembly area to LD.** Position location systems can locate a unit's position within an assembly area. A waypoint with the grid location of the center unit's area would ensure proper placement within the assembly area. Waypoints at the start point (SP), the release point (RP), and perhaps along the route would help to guide the unit to the LD.
- **LD to objective.** After crossing the LD, the unit could enter key points along the axis of advance as waypoints. Additional waypoints on checkpoints or coordination points would help to positively identify the unit's location.
- **Phase lines (PL) and limit of advance (LOA).** PLs are necessary to coordination of the attack, but the terrain does not always lend itself to easily identifiable PLs. With the global positioning system (GPS), PLs can be placed without reliance on terrain features. The border alert feature will sound an alarm when the unit reaches a designated line on the ground. The same method can be used for locating an LOA line.

- On the objective. Once on the objective, platoons will consolidate and reorganize. In directing the platoons' defensive fire orientation, a distant point, such as a target reference point (TRP), can be selected and entered as a waypoint. The platoon would then take a range/bearing to the point and use that bearing as their orientation. If fuel and ammunition resupply is not performed at the platoon location, the resupply site can be entered as a waypoint to help subordinate units pinpoint its location. The same process can be used to locate collection points for maintenance, EPWs, and wounded.

**Uses in Defensive Operations.** Uses of position location devices during defensive operations include the following:

- Battle position. In establishing a BP, a unit can use the anchor watch feature of most position location systems to ensure that all elements are within the proper area. The anchor watch sounds an alarm whenever the unit moves too far from a designated center point. Once a vehicle has established its location on primary and subsequent BPs, that location can then be saved as a waypoint to aid in finding it again later.
- Position location systems can also assist movement from one BP to another, particularly during limited visibility. During the reconnaissance/rehearsal of the route, stop and enter your current position as a waypoint at all critical locations such as trail crossings, fords, obstacles, or turns. Each point will be saved in sequence. You can then follow the sequence of waypoints between the BPs.
- Fire planning. Waypoints can also be used to ensure proper orientation of fires using the range and bearing feature.
- Movement. In a passage of lines, the unit that establishes the passage can give grid coordinates of entry points, release points (RP), and critical turns to the passing unit. These coordinates are entered as waypoints. The passing unit can then follow the waypoints and ensure a safe passage without danger of getting lost or wandering into obstacles.

## READINESS CONDITIONS

A readiness condition (REDCON) establishes the time necessary for the unit to move or be combat ready. It reflects the commander's expectation of how ready the unit is for combat. The unit SOP should describe REDCON in terms of the critical tasks of preparation that the unit has completed and the time available to prepare. Figure 2-6 is a sample list of REDCON levels with an explanation of each level.

<p><b>REDCON 1: Full alert, ready to move and fight.</b></p> <ul style="list-style-type: none"> <li>-All personnel alert and prepared for action.</li> <li>-Vehicles loaded and secured, and weapons manned.</li> <li>-Platoons ready to move on notification.</li> <li>-Engines started.</li> </ul> <p><b>REDCON 2: Stand to complete, ready to fight.</b></p> <ul style="list-style-type: none"> <li>-Precombat checks complete.</li> <li>-Equipment stowed (except for wire, NBC alarms, and communications gear).</li> </ul>
--

Figure 2-6. Readiness conditions.

<p><b>REDCON 2: Stand to complete, ready to fight (Cont).</b></p> <ul style="list-style-type: none"> <li>-Prepared to move or fight in position, infantry is dismounted in fighting positions.</li> <li>-Status reports submitted to company team CP.</li> <li>-Vehicles ready to move in 15 minutes, if Class IV (mines, concertina, overhead cover, sand bags) are abandoned.</li> </ul> <p><b>REDCON 3: Reduced alert.</b></p> <ul style="list-style-type: none"> <li>-Fifty percent of each crew, squad stand down for feeding, rest, and maintenance.</li> <li>-Remaining personnel man vehicles and OPs (including air guards, weapons) prepare positions and obstacles, and monitor radios and phones.</li> <li>-Vehicles ready to move within 30 minutes of notification. Most Class IV can be recovered.</li> </ul> <p><b>REDCON 4: Minimum alert.</b></p> <ul style="list-style-type: none"> <li>-OPs manned and one man alert per platoon, monitor radios and man turret weapons.</li> <li>-Vehicles ready to move in one hour. All Class IV not permanently emplaced can be recovered.</li> </ul>
---

Figure 2-6. Readiness conditions (cont).

## Section VI. Operations Security

OPSEC is all measures taken to maintain security and achieve tactical surprise. Units must deny the enemy information about planned, ongoing, and after-operation activity until it is too late for the enemy to react effectively. This section will summarize OPSEC in terms of countersurveillance, information security, signal security, and physical security.

Light armor units are extremely vulnerable to surveillance. The AO, especially in operations other than war, will consist predominantly of dismounted infantry and wheeled utility vehicles. The M8's unique signature (such as noise, dust, and thermal) in this environment will make it more easily detectable. These factors make OPSEC a top priority at every moment of every light armor operation.

### COUNTERSURVEILLANCE

Countersurveillance involves taking measures to protect friendly activities from being observed or detected (visually, electronically, or seismologically) by the enemy. Examples of countersurveillance measures and guidelines that apply to them:

**Noise and Light Discipline.** Follow these guidelines:

- Shield all light sources from enemy view.
- Move only when necessary.
- Use headsets or combat vehicle crewman (CVC) helmets to avoid radio noise.
- Do not slam hatches or doors.



- Use the short count method to start engines simultaneously.
- Perform resupply and maintenance in areas that are masked by terrain.
- Sandbag or shield generators.
- Use hand-and-arm signals when possible.
- Use extra precaution at night when noise and light carry farther.
- Do not allow smoking outdoors at night.

**Camouflage.** Follow these guidelines:

- Place tree branches or other vegetation on vehicles; hold them in place with commo wire. Drape camouflage nets over turrets.
- Park vehicles in natural concealment and shadows.
- Cover all headlights, mirrors, and optics when possible.
- Enhance camouflage paint with white wash (in winter) or mud when possible to break up the outline of the vehicle (see FM 20-3).
- Consider the effects of dust and smoke when moving.
- When possible, ensure vehicles drive in the tracks created by the vehicles ahead of them or in previously created tracks.
- Blend vehicles with other objects having a thermal emission.

**Concealment.** Follow these guidelines:

- Disperse vehicles and personnel under foliage or inside structures when possible.
- Conceal vehicles behind objects that can block the thermal line of sight.
- Keep vehicles traveling on existing tracks or roadways in heavily used areas, such as CPs and trains.

**Challenge and Password.** Ensure these are used and enforced.

**Air Defense.** Consider ADA coverage against enemy air reconnaissance.

**Jamming.** Use the following procedures:

- Consider jamming to disrupt enemy communications.
- Destroy enemy jamming, direction finding, and intercept equipment.

**Counterreconnaissance.** (See Chapter 6).

**Smoke.** Screen enemy observers and friendly movement with smoke.

**Deception.** In most instances, it is impossible to keep armor vehicles from being detected or observed by enemy forces because of their large signature. Deception plans should be employed so that friendly routine actions are conducted with greater uncertainty. Deception can play a significant role in masking the movement of formations, and inducing the enemy to miscalculate friendly objectives or weaknesses.

## **INFORMATION SECURITY**

Information security is the protection of friendly information. Leaders can help prevent compromising sensitive information by—

- Ensuring soldiers do not send critical information in the mail.
- Policing areas to ensure nothing of value is left behind.
- Destroying overlays, orders, and other documents after use or when they are no longer necessary.

## **SIGNAL SECURITY**

Signal security is a vital component of OPSEC procedures. Take the following steps to protect friendly communications:

- Use secure communications means or operational and numerical codes.
- Use low-power transmissions and terrain to mask signals from enemy direction-finding equipment.
- Keep radio transmissions short. Messengers or wire should be used for lengthy messages.
- Units must practice using signal operation instructions (SOI), SOPs, and operational terms. The battalion establishes priorities for issue of SOI and extracts.
- Protect cryptographic systems and classified documents from capture or loss. Before an area is vacated, inspect it for any materials that could provide friendly information to the enemy.
- Patrol wire lines to prevent enemy tapping.
- When SOI codes or cryptographic equipment is lost or captured, report the facts promptly to the next higher command. The unit SOP must contain instructions for destruction of equipment and classified documents to prevent capture or use by the enemy.

## **PHYSICAL SECURITY**

Physical security is the protection of material and equipment. Some examples of physical security include—

- Employing guards, OPs, and patrols at all unit and CP sites.
- Employing anti-intrusion devices, such as platoon early warning systems (PEWS) and trip flares, when stationary.

# **Section VII. Continuous Operations**

## **EFFECTS**

C2 degrades most rapidly in continuous operations. After 48 hours, a total loss of sleep has a significant adverse effect on all soldiers. Fatigued soldiers become careless; they make more errors, have difficulty following instructions, and lack the motivation necessary to

accomplish critical tasks. Several factors influence the degree to which fatigue affects soldiers during continuous operations: water consumption, diet, physical conditioning, personal hygiene, and availability of meaningful work. All soldiers should watch for the following symptoms of fatigue, both in themselves and in others:

- Headaches.
- Poor personal hygiene.
- Impatience or irritability.
- Loss of appetite.
- Inability to focus on the task at hand.

Soldiers with these symptoms may suffer from such problems as—

- Increased errors on the job.
- Difficulty in following instructions.
- Lack of motivation.
- Carelessness.

All soldiers should know these facts about sleep deprivation:

- Sleep deprivation is a primary safety concern, especially for vehicle drivers and operators of dangerous equipment.
- You cannot train to overcome sleep loss.
- Soldiers who are suffering from fatigue or sleep loss are most likely to fall asleep when performing tasks that are lengthy and uninteresting.
- Tasks that have been thoroughly learned and rehearsed are more resistant to sleep loss effects.
- Performance of mental tasks requiring calculations, creativity, and the ability to plan ahead declines by 25 percent for every 24-hour period of semicontinuous work without sleep.
- Leadership ability cannot overcome sleep loss. Leaders are vulnerable to the effects of sleep loss just like other soldiers; it degrades their ability to make quick and effective responses to changing battlefield conditions.
- The best-trained soldiers should be selected to perform critical tasks.
- The ability to learn new information is compromised by sleep loss.
- Sleep loss has a cumulative effect over time (more than 2 days).

## KEY LEADER SUSTAINMENT

The most reliable remedy for lack of sleep is sleep itself. Leaders should attempt to sleep before the onset of continuous operations. This period of sleep, if finished just prior to the start of operations, will delay the onset of serious sleep loss effects.

**Sleep Priority.** Units should establish disciplined sleep priorities, focusing on the following key personnel:

- Leaders on whose decisions mission success and unit survival depend.
- Soldiers who make important calculations or judgments.
- Soldiers who perform surveillance operations.
- Other soldiers.

**Action/Sleep Tradeoff.** Each leader must decide, based on professional judgment, whether additional work or sleep on his part will contribute most to mission success and unit effectiveness. Leaders must realize they are not capable of controlling their unit 24 hours a day for days on end. During continuous operations, the leader and the XO, S3, or senior subordinate commander should be on complementary shifts to provide control at all times. Units should include plans for such a schedule in their SOPs. A rested leader with a plan made by his XO may be better than a leader suffering from sleep loss who makes his own plan. The leader must also keep in mind that this decision will probably be made when the leader's reasoning process is already blurred by lack of sleep.

**Recovery from Sleep Loss.** In the uncertainty of combat, leaders will normally not be able to schedule enough rest to fully recover. Leaders should make the most of even small breaks. Only four hours of sleep provides leaders with substantial recovery of simple tasks. Horizontal sleep is the best and should be the goal. Recovery increases with each four-hour block of sleep. Even short "cat naps" significantly enhance recovery.

**Adjusted Command and Control Procedures.** As sleep loss for the unit increases, leaders should—

- Give simple directions with few secondary tasks.
- Give complete, clear, and precise orders.
- Repeat all orders.
- Double-check themselves and others to ensure orders are carried out.
- Reassure soldiers more often.

**When and Where Commanders Sleep.** Upon receipt of a new mission, the commander should complete the command estimate and issue orders first. Then he should rest or sleep while subordinate units are completing their planning. Commanders can also sleep during road marches or other movements when the unit is not in contact with the enemy. Commanders should be awake at least 90 minutes prior to the onset of the battle.

Commanders normally sleep at the tactical command post (TAC CP), giving the officer in charge (OIC) instructions on circumstances under which they should be awakened. The unit SOP should contain a basic list of circumstances, which are modified according to the situation, and provide for who is in control while the commander is sleeping. If possible, the XO at the tactical operations center (TOC) should be awake and in control at this time.

If the commander is not able to go to the TAC CP to sleep, he should sleep at the site of the nearest subordinate commander or CP. By doing this, his crew will be able to sleep, he will be close to long-range radios, and he can rely on CP personnel to awaken him at the proper time.

## UNIT SUSTAINMENT

When conducting combat operations for longer than 48 hours, the leader must employ techniques for sustaining the combat effectiveness of his subordinate units. He faces the basic choice of using unit replacement or of decentralizing responsibility for sleep plans to his subordinate commanders.

**Unit Replacement.** When possible, commanders tasked with reconnaissance operations should employ the unit replacement method. No soldier is capable of performing reconnaissance continually over a period of several days. The commander may decide to halt his entire unit for rest, or he can maintain momentum of the movement by periodically introducing fresh subunits to pass through units that are fatigued.

A technique for commanders who are contemplating extremely long operations is to designate daylight and night units. Units in reserve should take advantage of all available time to recover. Commanders may also enhance subunit recovery by carefully selecting REDCON levels allowing subunits to get the maximum rest possible.

**Decentralized Sleep Plans.** When mission requirements call for the entire unit to be employed, or the unit is tasked to perform a stationary mission, leaders at platoon, section, and crew levels must manage sleep plans. Commanders should be aware of several considerations:

- The length of shifts and rest periods can be managed in several ways: 4 hours on, 4 hours off; 16 on, 8 off; or 12 on, 12 off.
- Rotate tasks (surveillance, security, patrolling) frequently.
- When degradation is substantial, task teams of two or more soldiers to perform the important tasks (radio watch and surveillance).
- Ensure OPs are manned by crews or sections.

**Other Sustainment Techniques.** Additional techniques include the following:

- Sleep up to 12 hours before the start of continuous operations.
- Ensure mild stimulants, such as coffee or cola, are on hand.
- Synchronize wake/sleep cycles with the combat zone's local time as early as possible (redeployment if feasible).

**CONTINGENCY OPERATIONS**

CONOPS are crisis situations involving imminent military action. Light armor units take part in such operations with light infantry forces. This chapter is not intended to repeat information found in other manuals. Rather, it examines the nature of light armor unit employment as part of division, corps, and JTF CONOPS; the stages of CONOPS; and how light armor units fit into each stage. Additional information on the characteristics of division CONOPS and planning systems is in FM 71-100. Corps CONOPS and planning systems are discussed in FM 100-15.

CONTENTS	
	Page
Section I. Fundamentals of Contingency Operations . . . . .	3-1
Types of Contingency Operations in Operations	
Other Than War . . . . .	3-3
Light Armor Employment in Contingency Operations . . . . .	3-5
Support Considerations. . . . .	3-5
Section II. Force Projection Operations. . . . .	3-7
Preparation and Planning. . . . .	3-7
Predeployment Activity . . . . .	3-9
Deployment . . . . .	3-10
Entry Operations . . . . .	3-11
Operations. . . . .	3-12
Postconflict Operations. . . . .	3-14
Redeployment and Reconstitution . . . . .	3-14

**Section I. Fundamentals of Contingency Operations**

CONOPS involve military forces to achieve US objectives or protect national interests. They are usually in response to a sudden or short-notice crisis or emergency and occur across the scope of operations. Army forces, including armor, may take part in several types of CONOPS involving other US services or an allied or coalition contingency TF. CONOPS are usually terminated in their own right or evolve into sustained operations. They may serve to—

- Defend US citizens and interests abroad.
- Support foreign policy.
- Promote regional stability.
- Defuse a sudden crisis or contain spontaneous conflict.

## FM 17-18

- Conduct short-notice humanitarian assistance, disaster relief, and NEOs.
- Conclude military operations on terms favorable to US interests and objectives.

CONOPS are quick-response actions that are designed to bring early resolution to a crisis. They require the following:

- Rapid projection of CONUS-based combat power.
- Timely, detailed intelligence of objective area.
- Opposed entry capability.
- Precise C2 during initial stages.
- Joint war fighting expertise.
- Practice.

US Army light divisions may be required to respond to a variety of contingencies or to rapidly reinforce US and allied forces deployed anywhere in the world. Conflicts in these areas may be at any level on the continuum. The versatility of light armor presents planners with multiple employment options. Selection of the preferred option or a combination of options is based on careful consideration of the terrain, the type enemy expected to be encountered, and the inherent capabilities and limitations of light armor. Light armor units must be prepared to—

- Augment, task organize, and support the light infantry TF before deployment. When this option is selected, units assigned to support the TF must possess strategic mobility compatible with the parent unit.
- Augment, task organize, and support the light infantry TF after deployment. Forward-deployed light infantry forces can be quickly augmented by light armor units. The LID's C2 structure has the capability to accept and quickly integrate these assets into the scheme of maneuver.
  - Task organize the light armor unit to meet theater-specific requirements.
  - Employ light armor as it is organized. In this instance, the unit's maneuver manpower, tactical transportation assets, FS, and logistic capabilities must be considered to determine what is needed for sustainment.
  - Designate selected items of pre-positioned equipment in theater for issue to the light armor unit.

Regardless of the option selected, on arrival in theater, the light armor unit becomes an integral part of the larger infantry force, normally the battalion, brigade, division, corps, or JTF to which it is attached. Light armor may deploy for operations in areas where there are no US or allied bases and where the indigenous population ranges from friendly to neutral to overtly hostile to US forces.

CONOPS require that the force first be tailored for the specific mission, then echeloned to permit simultaneous deployment and employment. The division organizes into an assault echelon, a follow-on echelon, and a rear echelon. Light armor units will normally deploy in each of these echelons. The initial assaulting echelon must organize with sufficient combat power to seize the lodgement and begin combat operations. The echelon that immediately follows must be equipped to expand the lodgement and undertake decisive combat operations. The final echelon must provide the sustainment for expanded operations.

A secure airfield, port, or beach must be available for resupply; it must be by the host nation, other US forces, allied forces, or an irregular force. Local air superiority and TACAIR support are essential in all stages of a CONOPS.

## TYPES OF CONTINGENCY OPERATIONS IN OPERATIONS OTHER THAN WAR

The following paragraphs discuss in greater detail the types of CONOPS in which armor forces may participate in operations other than war. A crisis response involving light armor directly into war is also a CONOP, but would involve combat operations as described in Chapters 4, 5, and 6.

**NOTE:** There are other types of CONOPS in operations other than war that are not likely to involve light armor units except in extreme circumstances, including disaster relief, surveillance operations, and support to counterdrug operations.

**Noncombatant Evacuation Operations.** NEOs remove threatened civilian noncombatants from locations in a host foreign nation. NEOs normally affect US citizens, but they may also include selective evacuation of host-nation and third-country nationals. An NEO involves a swift insertion of a force and possible temporary occupation of an objective, followed by a rapid withdrawal.

Light armor force options for NEOs depend on the operational environment in which NEO will be conducted. Semipermissive and nonpermissive environments may require formation of an infantry/armor TF and/or deployment of combat and support forces from CONUS locations. Host-nation capabilities, to include airstrip facilities, will play a major role in determining force options for NEOs. The TF commander should consider a light armor force option that provides both early response to a developing situation and the capability to quickly expand should the environment become more hostile.

**Show of Force and Demonstration.** Shows of force and demonstrations lend credibility to US promises and commitments, increase the nation's regional influence, and demonstrate its resolve. They can take the form of combined training exercises, forward deployment of military forces, or introduction or buildup of military forces in a region.

Light armor force options for shows of force and demonstrations range from a single TF with a light armor platoon to a massive deployment and buildup of a joint US military force involving one or more light armor battalions. Such a buildup would often occur as part of a regional allied or coalition show of force or demonstration.

**Security Assistance Surge.** Security assistance surges are employed when a friendly or allied nation faces an imminent military threat. They are normally focused on providing additional combat systems (weapons and equipment) or supplies, but may include the full range of security assistance, to include financial and training support.

Some limited security assistance surges may be conducted by forward-deployed forces; however, most surges will require deployment of combat systems and/or supplies from CONUS locations via strategic airlift. Light armor gives the contingency commander an armor option with airlift deployment capability.

**Quarantine and Blockade.** Quarantines and blockades often follow shows of force or demonstrations and may be conducted as precursors to further escalation of military actions. Their purpose is to restrict movement of persons and things from entering and/or leaving a designated country. Quarantines are less restrictive than blockades and normally target



specific types or classes of persons and things. Blockades are very restrictive and normally prohibit all persons and things from entering and/or leaving the designated country. Quarantines and blockades normally involve air, land, and sea operations to stop, search, and divert or redirect commercial and military means of conveyance. They require clearly articulated rules of engagement (ROE) as well as extensive coordination within the quarantine and blockade forces, especially when regional allied or coalition forces are participating.

Depending on geography, quarantines and blockades normally involve a combination of air and surface forces. Light armor units provide surface forces with tactical mobility and firepower that enable them to mutually support and communicate with other contingency forces. Light armor units may have to reinforce forward-deployed forces, regional allied forces, and/or coalition forces used to initiate a quarantine or blockade.

**Strike and Raid.** Strikes and raids damage or destroy HVTs and demonstrate US capacity and resolve to protect regional interests and/or achieve specific objectives. They usually involve the use of violently destructive military power against predetermined objectives through employment of air, land, sea, and/or special operations. Strikes most often involve direct application of weapon systems against objectives; raids normally involve temporarily seizing and/or destroying objectives, followed by rapid and preplanned withdrawal of raid forces.

Strikes and raids are normally conducted with regional allied or coalition forces whenever possible. They usually involve joint forces tailored for a specific mission, but may involve only single-service forces or special operations forces (SOF). Light armor capabilities provide the strike/raid force with firepower that can be rapidly introduced into (opposed entry) and removed from the objective area.

**Rescue and Recovery.** These operations include the rescue or recovery of US and/or friendly foreign nationals and the location, identification, and recovery of sensitive equipment or items critical to US national security. Rescue/recovery operations are normally conducted in a clandestine or covert manner. They require accurate intelligence, a great deal of detailed planning, highly trained rescue/recovery forces, and appropriate operational support such as insertion and extraction vehicles, communications equipment, and FS. Rescue/recovery operations are normally highly classified during planning and execution.

Rescue/recovery operations are normally conducted by highly trained and specialized forces operating from land- and/or sea-based safe havens as close as feasible to the objective area. They may include limited participation by allied or coalition assets. Under certain conditions, they include light armor units when additional firepower, security, or shock effect (through use of a feint or diversion) is needed. Some specialized training may be required for such operations.

**Operations to Restore Order and Intervention Operations.** These are intended to halt violence and reinstate more normal civil activities. Where applicable, they are employed to encourage the resumption of political and diplomatic dialogue. They often evolve into peacekeeping operations; forces tasked to conduct such operations may be opposed by considerable numbers of belligerents in a situation that could suddenly deteriorate into combat. PSYOP and civil affairs forces normally play important roles in these operations.

Operations to restore order and intervention operations normally involve mostly ground forces, but they may also require air, maritime, or special operations support. Force protection, evacuation, and the potential for offensive and defensive combat operations make light armor involvement likely. Forward-deployed US forces and/or regional allied or coalition forces often initiate these operations to serve as the nucleus for follow-on forces from CONUS or other overseas locations.

## LIGHT ARMOR EMPLOYMENT IN CONTINGENCY OPERATIONS

Light armor units do not conduct CONOPS alone. Rather, they fight as a combined arms team with other forces. Possibilities for task organization could be a light armor platoon operating with a battalion-size force, a light armor company with a brigade, and a light armor battalion with a division. Light armor executes armor-related missions and tasks in support of the overall contingency mission. For example, when a TF conducts an NEO in a nonpermissive environment, light armor may have to conduct an attack with infantry to seize key terrain or occupy blocking positions that secure the noncombatant area. Other forces could then notify, gather, document, and move the evacuees. Light armor might subsequently provide convoy security to the point of debarkation.

Command guidance and the characteristics of CONOPS affect the way light armor is used in such operations. In employing light armor, the CONOPS commander can—

- Quickly task organize or tailor an attachment to light infantry or another headquarters for rapid deployment and/or combat.
- Plan for simultaneous deployment and employment of a force. Fighting may well begin before the whole force or support elements can be in position.
- Deploy a force directly into combat by opposed entry into an AO.
- Provide an operational headquarters capable of conducting rapid response, quick deployment, and fast, decisive, offensive operations. A light armor headquarters element must be able to move into the objective area early to assist in C2 of follow-on units in a build-up. This element can also assist coordination and control of support for light armor units already in the AO.

Table 3-1 shows a list of potential tasks and missions that light armor units may execute during CONOPS. This list is not all-inclusive, though it shows which CONOPS will most likely involve light armor units. It is extremely difficult to match all possible missions/tasks with each type of contingency. Each crisis and operation will bring with it a unique mission, environment, and threat. Commanders must analyze the factors of METT-T for each situation to determine the most appropriate solution. Chapters 4, 5, and 6 of this manual discuss missions and tasks light armor units may have to perform as part of these operations.

## SUPPORT CONSIDERATIONS

CONOPS forces must establish C2 as well as CSS virtually from the start of the operation. Employment of light armor forces is not as simple as putting combat forces first, followed by CS and CSS; it requires corresponding echelonment of CSS. Rapid transition to decisive combat or other operations dictates that CSS accompany or closely follow each echelon. CSS organization and supply quantities must be carefully analyzed, taking into account such factors as potentially scarce transportation assets and the austere infrastructure of light infantry CSS assets.

Other CSS considerations apply when light armor is required to operate with other services. Support requirements and supply quantities depend on the mission, but the capabilities of the parent unit's CSS assets could easily be overtaxed. Proactive planning is necessary to ensure the light armor force, whatever its size, has accompanying CSS support. Echelonment is the key; redundancy is essential.

Light armor units may require augmentation for resupply and maintenance support during some CONOPS. When an operation is conducted in stages, detailed planning is necessary to ensure the force is sustained in each stage. It is critical to synchronize the deployment of CSS units, supplies, and CSS C2 with the increase in combat capabilities.

Augmentation may take two forms. In the first, combat, CS, and/or CSS elements may be added to the light armor unit to enable it to perform effectively in an environment in which its basic organization requires augmentation. The second form entails staff augmentation, provided when expertise not organic to the battalion staff is needed or when units of a type not normally found in the division are added. Some examples of this form might be augmentation of a unit with interpreters, an ANGLICO, or a civil-military affairs officer.

Table 3-1. Examples of light armor missions and tasks in contingency operations.

CONTINGENCY OPERATION	OPERATIONAL ENVIRONMENT	EXAMPLE MISSIONS/TASKS
*Noncombatant evacuation	Peace Conflict War	Attack to seize terrain that secure evacuees or departure area Guard Convoy security for evacuees Defend/delay against attacking enemy force
Show of force/ Demonstration	Peace	Perform tactical movement Occupy battle positions
Security assistance surge	Peace Conflict	Attack Defend Delay Guard Screen
Quarantine/ Blockade	Conflict War	Screen a border/road network Guard Occupy/defend battle position
*Strike/Raid	Conflict War	Attack to destroy Attack to seize
*Rescue/ Recovery	Peace Conflict War	Attack Defend Guard Recon
*Restore order/ Intervention	Conflict	Attack to seize terrain Screen Guard Defend
* May require opposed entry capability.		

Augmentation places special demands on the battalion staff and the C2 system. The staff must be prepared to integrate augmentation units and staff elements into the battalion structure and to employ these elements effectively. The C2 system must accommodate additions and deletions from this force structure without disruption or degradation of operations.

Light armor may also require augmentation from division or corps units to conduct extended operations. It is imperative that the corps remain responsive to the battalion's operational needs and provide the required augmentation.

When elements of the light armor battalion are task organized throughout the division, the battalion normally does not possess the required logistical redundancy to sustain them. These

elements usually must deploy with their unique sustaining support packages, which are either organic or are provided by division and/or corps assets. Special consideration should be given to maintenance, repair, and supply. See Chapter 8 for a discussion of support operations.

## Section II. Force Projection Operations

CONOPS are conducted in stages. The eight stages provide the general planning and execution structure and can be adjusted to fit the needs of a particular contingency. They are—

- Mobilization.
- Predeployment activity.
- Deployment.
- Entry operations.
- Operations.
- Postconflict operations.
- Redeployment and reconstitution.
- Demobilization.

Execution of these stages may not be distinct. Operations may begin well before the force has completed previous stages. This section briefly discusses the stages from a light armor perspective following an examination of preparation and planning procedures. Refer to FM 100-17 for information on mobilization and demobilization.

### PREPARATION AND PLANNING

CONOPS for a light armor unit begin when it is notified to deploy. Time is very limited and requires the unit to be prepared to react immediately. Several operational and administrative activities can be accomplished prior to notification. Light armor units will be better prepared to execute CONOPS if the following activities are conducted

- Readiness SOPs and alert notification procedures are usually dictated by division SOP. The light armor unit's alert and deployment procedures must be developed, practiced, and refined to reduce dead time and increase efficiency in execution.
- Training with light infantry should be on a regular basis, not only for tactical training but for alerts and deployments as well. Light armor platoons and companies are task organized with light infantry battalions and brigades during contingency force readiness postures. When not in an immediate deployment status, light armor platoons and companies conduct training, maintenance, and support cycles to maintain readiness.
- A light armor unit should undergo an operational readiness inspection of all systems prior to assuming mission readiness responsibilities. Precombat inspection checks should be conducted during these readiness inspections as well as when alert notification is received.

- Ammunition load plans and support requirements can be anticipated and prepackaged. Ammunition placed in the installation ammunition supply point in the configuration needed for loading on vehicles (ballast) and for resupply (bulk) will make deployment easier.
- Light armor units will usually deploy in platoon assault packages. Airlift load plans required by the Air Force can be prepared to reduce processing time for the unit at the departure airfield.
- All Air Force aircraft require wood shoring for tracked vehicles loaded in an airlanding configuration. The unit must maintain a sufficient supply of shoring to ensure that time is not lost during predeployment activities. Planning for shoring includes transportation assets to get the material to the departure airfield, as well as the manpower required to load and offload. See Appendix A for more information on shoring materials.
- Unit readiness SOPs and procedures should include plans for determining who will provide the manpower to outload the deploying unit. Because of the nature of rapid deployment, deploying unit personnel will not normally be involved in vehicle outload preparation. During notification, unit personnel will be heavily involved in receiving/giving OPORDs, conducting rehearsals, and receiving individual issue of equipment and ammunition. Crew members may not link up with their vehicles until they arrive at the departure airfield (during airlanding) or on the drop zone (DZ) after an airborne operation. Elements of the light armor battalion normally will not deploy simultaneously. Plans may simply task one or more of the other companies in the battalion to assist in manpower and transportation requirements during predeployment. If the entire battalion eventually deploys, the last elements will need assistance from outside the unit.
- Telephonic and nontelephonic alert and notification rosters must be updated and rehearsed frequently.
- Above all, deployment activities and procedures must be practiced and rehearsed to improve unit readiness.

Administrative preparation will also reduce the number of complications during short-notice deployment. Light armor units should consider the following list of basic preparations when preparing to assume a contingency mission readiness posture:

- Overseas movement packets should be inspected and updated as often as required by division and army regulations.
- Immunization and dental records must be kept current.
- A- and B-bag packing lists should be predetermined. Bags should be packed upon assumption of mission readiness; a plan should be in place that allows for the unit to collect and ship the bags to the deployed unit if required.
- Hand receipts for sensitive items and other equipment can be filled out, without signatures, to save time during the deployment sequence.
- Privately owned vehicle (POV) plans must be determined and coordinated, including storage parking and key control.
- Plans for billets vacated by deployed units, to include storage of personal belongings, must be completed to reduce complications.

- Wills, powers of attorney, single-parent arrangements, and single-soldier debt payment plans must all be developed and finalized prior to assuming mission responsibility.
- Family support group rosters and notification plans are extremely important. These plans must be made prior to deployment notification.
- Rear-detachment structure and procedures must be identified in advance; this will reduce deployment turbulence and ease coordination of all types of administrative activities.

## PREDEPLOYMENT ACTIVITY

This is the critical stage of CONOPS. The objective for the contingency commander is to select and task organize a force and to quickly develop or refine operational concepts that will set the conditions for subsequent stages of the campaign. The need to plan and prepare for strategic deployments in the compressed time frame of a crisis will be a particularly demanding aspect of this stage. During this stage, decisions will be made that affect the size of light armor participation in the operation. The contingency force commander will determine the size of the force, the time required to initiate and deploy the force and the airlift requirements for deployment.

Light armor units must be prepared for short-notice contingencies. Alert and notification procedures in the unit will be conducted within a specific number of hours as dictated by the mission and the division's readiness SOP. For example, the airborne division may require an airborne light armor battalion to be able to deploy its initial element 18 hours after notification. The requirement varies among divisions. The unit can anticipate tasks to be accomplished in the alert and deployment sequence.

CONOPS begin when the unit is notified to deploy. The announcement initiates predeployment activities. Sometimes, during the Joint Chiefs of Staff (JCS) crisis assessment, the parent HQ (corps/ division) will receive a WO. The division or corps may then initiate planning and advise its subordinate HQ of the impending contingency. This planning sequence is called the X-hour sequence. The staff begins to anticipate requirements and sequence activities that will facilitate its transition into the deployment and initial combat actions phase.

Based on information provided by the corps, the division task organizes a force to meet specific tactical requirements. Temporary C2 facilities and organizations to support the operation are established early.

**X-hour Preparation Sequence.** CONOPS are by nature executed with limited time available. The X-hour sequence gives units a jump on execution planning and preparation before receipt of the actual alert order; it has no set time windows to meet. All actions depend on the situation and the information received from division HQ.

During X-hour activities, the battalion staff will begin monitoring the situation. The S2 may begin an analysis of the potential objective area or AO, if known. When no X-hour sequence is initiated, reaction time will be minimal.

When the decision is made to initiate military action, the NCA, through the JCS, issues an executive order to the commander-in-chief initiating the N-hour sequence. Forces are alerted and marshaled to begin preliminary measures to facilitate deployment. Normally, the initial assault forces will have 18 hours to begin deployment. This initial TF will range from battalion to brigade in size, including light armor from section to company level. Normally, the force package will be determined in COA development; however, it may be tailored during predeployment planning because of such factors as a lack of airlift and sealift capability or a change of mission.

**OPSEC Considerations.** The need for OPSEC is paramount throughout the notification and deployment activities. All units must take steps to reduce unnecessary dissemination of mission information. In some instances, when secrecy is needed, units may be required to conduct deception operations or move to a remote staging area to keep from compromising the mission.

**DEPLOYMENT**

The means of deployment depend on the capabilities of the light armor unit and the commander balancing the factors of METT-T against available airlift and sealift assets. Each crisis will have unique demands. Commanders must task organize and deploy light armor with other forces to fix mission requirements.

In this example, a brigade headquarters serves as the base for each assault force and is complemented with appropriate combat (including a light armor company), CS, and CSS units. One of the brigades is designated the lead unit and contains the assault elements for deployment. The brigade is maintained at a high state of readiness to meet the division's initial deployment requirement. The other brigades maintain various stages of readiness and deploy after the lead brigade. See Figure 3-1 for an example of the brigade assault force in the lodgement area.

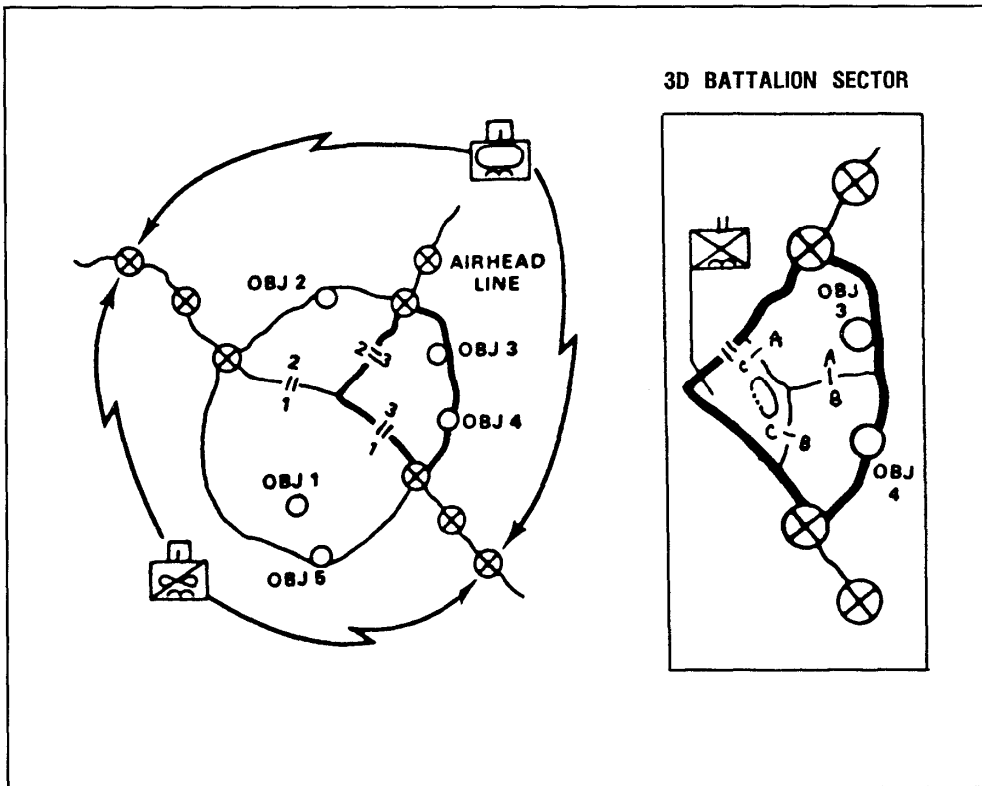

Figure 3-1. Brigade assault force in the lodgement area.

The majority of the assault elements of the brigade are typical tactical organizations with the exception of the division TAC CP. The TAC CP is manned with full staff representation and sufficient communications to conduct division C2 and to interface with echelons above division before the arrival of the main CP.

Those light armor elements (CS and CSS) not task organized to the assault force may be organized to deploy after the lead brigade. They are task organized to facilitate an advance party and additional operational elements, followed by the main body. The advance element prepares for the arrival of the remainder of the battalion while the operational element provides the necessary support to sustain operations of the light armor element. This structure of task organized elements also provides the light armor the flexibility to rapidly tailor and deploy support packages if the entire battalion does not deploy. With this type of organization, the battalion maintains a flexible base to respond to most situations within hours of notification.

In some deployments an intermediate staging base (ISB) is required. If the assault element requires C130 aircraft for an airborne drop or field strip landing and the deployment distant is too great, the armor vehicles may be transported to an intermediate base on C141 or C5 aircraft and transferred to the C130 for the assault (see Figure 3-2). The light armor vehicles may be rigged for airdrop in CONUS or at the ISB. If rigged in CONUS, then lift assets must be available at the ISB. If the armor vehicles are configured for airdropping, the vehicles simply offload from one and load onto the other aircraft.

Prior to the execution of the entry stage, detailed planning is required for feeding, fueling, arming, maintaining, and loading the assault force at the staging areas and any en route bases. During this stage, the division support coremand (DISCOM) control party consists of individuals required for the receipt and issue of rations, fuel, and ammunition, and for the coordination and control of other essential CSS (maintenance and transportation) activities in support of the assault force. The armor assault force enters the AO with basic loads of Classes I, III (packaged and bulk), V, and IX (high demand items). Based on the enemy situation in the AO, the assault force may include Class V in bulk. Personnel from the DISCOM may establish an initial Class V point on the airhead or beachhead. Mortuary affairs during this phase is a unit responsibility.

## ENTRY OPERATIONS

This is the key execution stage, encompassing the occupation of the initial lodgements in the objective area. The strength and composition of the first elements of the force to arrive in the AO will depend on the factors of METT-T. Depending on the crisis, this stage may require opposed entry into a hostile, chaotic, or seemingly benign environment. Airborne light armor forces are best designed to achieve strategic surprise in this stage. Light armor units without this capability may receive augmentation and should therefore plan for opposed entry operations. Follow-on forces must be prepared not only to close into the objective area, but also to reinforce the assault. If an armor threat is present, a larger light

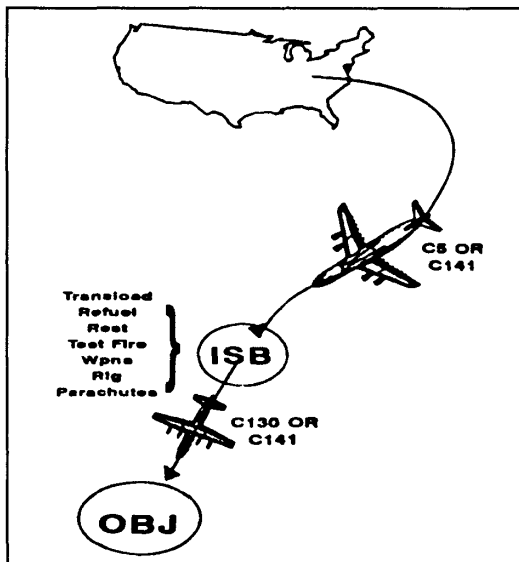

Figure 3-2. Intermediate staging base.



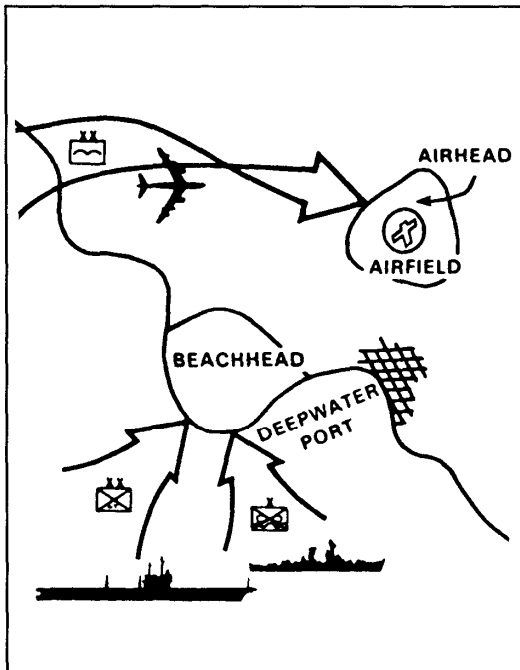

Figure 3-3. Opposed entry operations.

armor force must accompany the initial assault or immediate follow-on forces. Light armor units may have to conduct simultaneous deployment and employment of the force. This will place greater stress on the C2 of the light infantry/armor TF (see Figure 3-3).

Operations in contingency areas normally commence with the movement of the division's assault force into the contingency area by air or sea. The assault force lands on or close to objectives. USAF and Navy aircraft normally provide required FS during and after the airlanding operations. Operations are assigned to the assault force based on the factors of METT-T. The assault force secures its initial objectives to establish and maintain a secure lodgement and to protect it from direct fires and observed indirect fires; this will facilitate the landing of follow-on forces during the next phase of the operation. Cavalry and, in some instances, light armor elements provide reconnaissance and security and operate beyond the lodgement to gain enemy information and provide early warning.

## OPERATIONS

In this stage, light armor units are incorporated into the buildup of forces, then into combat operations (see Figure 3-4). The contingency force accomplishes the following tasks during buildup:

- Establishes a forward operating base.
- Closes the remainder of the force.
- Expands the lodgement.
- Links up with other joint forces.
- Moves out to engage the enemy in offensive and defensive operations.

The principal focus of this stage is to build up combat power as quickly as possible and rapidly expand combat operations (see Figure 3-5). The objective is to place a force on the ground that can fight while follow-on forces continue to arrive and prepare for subsequent operations. Speed is especially important since the success of decisive operations hinges on the force's ability to build combat power without losing the initiative. Inclusion of light armor forces is critical in ensuring that the contingency force has the necessary firepower to maintain mobility and take the fight to the enemy.

This stage begins with the introduction of follow-on forces into the airfield, beachhead, or port in the contingency area. Follow-on forces reinforce and support the assault force and establish lodgement. During this phase, sufficient combat power is generated and tactical operations are conducted to fully secure the lodgement area by expanding the security area out to the range of enemy indirect-fire weapons. Combat forces are employed as necessary to destroy, delay, or disrupt enemy forces threatening the lodgement. Air and naval aircraft and NGF provide FS. ADA is employed to provide air defense against penetrating enemy aircraft. A corps or JTF will normally assume command of the division as soon as its C2 and logistical base are established. Because the force buildup and combat actions phase of the CONOPS is the most critical point for the division, staff planners must ensure that the lead brigade is fully resourced for the mission.

C2 of light armor units in the lodgement area rests initially with the infantry TF (brigade or battalion) commander or a designated representative. However, as the remainder of the battalion arrives, the C2 of some of the light armor units may revert to the light armor battalion commander. The battalion XO or S3-Air is initially positioned at the departure airfield to synchronize and coordinate the flow of supplies, personnel, and equipment into the AO.

The size of the support package varies depending on several factors, including—

- Availability of host-nation facilities.
- Size of the force to be deployed.
- Available lines of communication.
- The threat.

During the early stages of the force buildup and combat operations, maintenance support will consist primarily of reliance on component repair, BDAR, and cannibalization of combat damaged equipment. As this stage progresses, host-nation facilities (if approved for use) may become available, as will the remaining elements of the division supply upon complete deployment. In the early stages, division supplies are received by air delivery. Distribution to supported units is

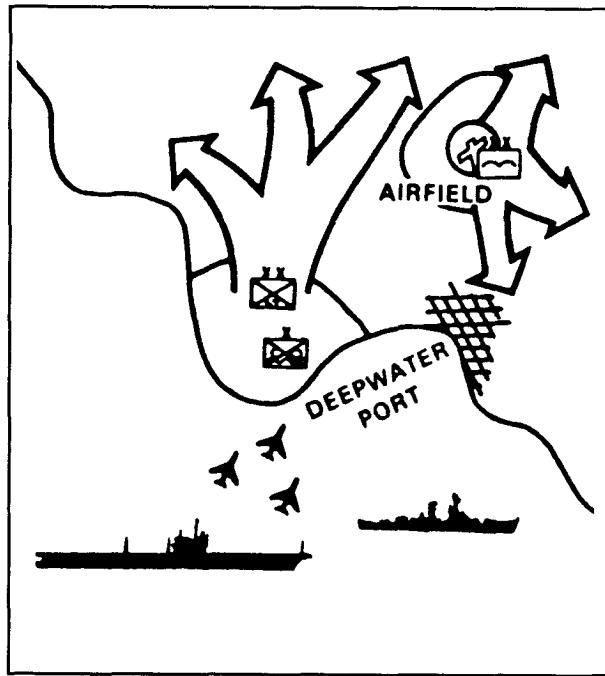

Figure 3-4. Operations stage.

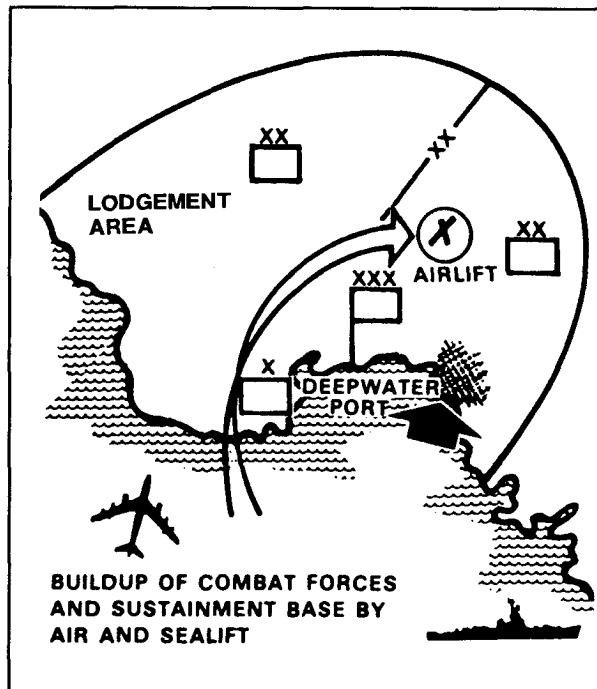

Figure 3-5. The operations stage showing an example of a buildup and combat operations.

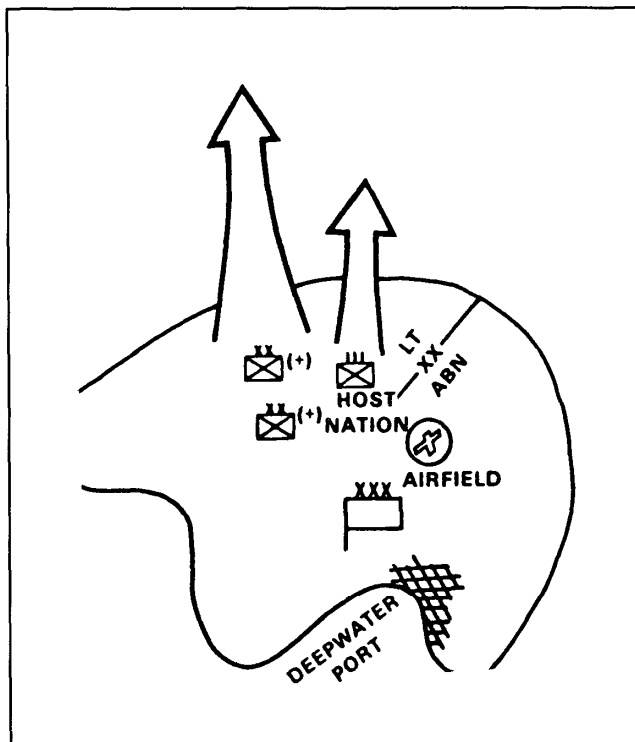

Figure 3-6. Decisive combat operations during the operations stage.

normally accomplished by a combination of supply point distribution and aerial resupply.

It is through decisive combat that the contingency force attains the objectives that achieve the purpose of the campaign. The operational methods and missions will vary with the nature of the crisis.

Decisive combat operations, depicted in Figure 3-6, is an extension of the operations stage. Combat forces and a logistics base are concurrently established and expanded to support decisive operations. As the situation in the lodgement area is stabilized, the division performs expanded combat operations to eliminate the enemy force as directed by its higher headquarters. Long-term and widely dispersed operations may require additional combat, CS, and CSS forces. See Chapters 4, 5, and 6 for a more detailed discussion of combat operations.

## POSTCONFLICT OPERATIONS

Once combat operations bring an end to the immediate conflict, light armor transitions to a period of postconflict operations. The postconflict operations stage focuses on those activities that occur after conflict ends. The emphasis is on restoring order and minimizing confusion following the operation, reestablishing the host-nation infrastructure, and preparing for redeployment. Light armor may provide security to the force in case of a resumption of hostilities, or assist in prisoner control and refugee handling.

## REDEPLOYMENT AND RECONSTITUTION

The objective of this stage to redeploy the force as rapidly as possible to CONUS, to an ISB, or to another theater of operations. In conjunction with this effort, redeployment and reconstitution of the light armor unit is necessary to handle other contingencies or operations in other theaters.

**LIGHT ARMOR PLATOON**

Although the light armor platoon is an integral part of the light armor company, it is capable of detaching from the company and then operating with a light infantry battalion. It is important for the light armor platoon leader to become familiar with the organization and operations of the light infantry. When the platoon operates with its parent light armor company, its fundamental employment is similar to that of an armor platoon as described in FM 17-15. This chapter describes the employment of the light armor platoon as it would apply to the support of light infantry.

**CONTENTS**

	Page
Section I. Organization . . . . .	4-2
Light Armor Platoon . . . . .	4-2
Light Battalions . . . . .	4-3
Augmentation . . . . .	4-4
Section II. Employment . . . . .	4-4
Platoon Missions . . . . .	4-4
Operational Planning Considerations. . . . .	4-4
Section III. Command, Control, and Communications. . . . .	4-7
Tactical Communications . . . . .	4-8
Formations . . . . .	4-9
Direct Fire Control . . . . .	4-15
Section IV. Offensive Operations.. . . .	4-17
Direct Fire Planning . . . . .	4-17
Techniques of Engagement . . . . .	4-18
Mounted Movement . . . . .	4-18
Basic Light Infantry Movement Techniques . . . . .	4-19
Methods of Light Armor/Infantry Movement. . . . .	4-21
Fire and Maneuver . . . . .	4-24
Battle Drills . . . . .	4-25
Actions at Danger Areas . . . . .	4-37
Offensive Missions with Light Infantry Battalions. . . . .	4-40
Forms of Maneuver . . . . .	4-41
Movement to Contact . . . . .	4-44
Methods of Attack . . . . .	4-47
Types of Attack . . . . .	4-48
Offensive Operations in Built-up Areas . . . . .	4-49
Raid . . . . .	4-58

<b>CONTENTS (cont)</b>	
Bypass . . . . .	4-58
Consolidation and Reorganization . . . . .	4-59
Limited Visibility and Terrain . . . . .	4-60
Section V. Defensive Operations. . . . .	4-62
Direct Fire Planning . . . . .	4-62
Preparation . . . . .	4-63
Defense of a Battle Position . . . . .	4-65
Defense in Sector . . . . .	4-66
Reverse Slope Defense . . . . .	4-67
Perimeter Defense . . . . .	4-70
Strongpoint Defense . . . . .	4-71
Defense in Built-up Areas . . . . .	4-72
Reserve Force . . . . .	4-74
Counterattack Force . . . . .	4-74
Limited Visibility . . . . .	4-75
Section V. Other Operations . . . . .	4-76
Lodgement . . . . .	4-76
Retrograde Operations . . . . .	4-77
Reconnaissance in Force . . . . .	4-79
Convoy Security . . . . .	4-80
Passage of Lines . . . . .	4-83
Linkup . . . . .	4-84
Breakout from Encirclement . . . . .	4-85
Relief in Place . . . . .	4-86

## Section I. Organization

### LIGHT ARMOR PLATOON

The light armor platoon consists of four M8 light tanks and 12 personnel organized into two sections of two M8s each. Figure 4-1 shows platoon organization.

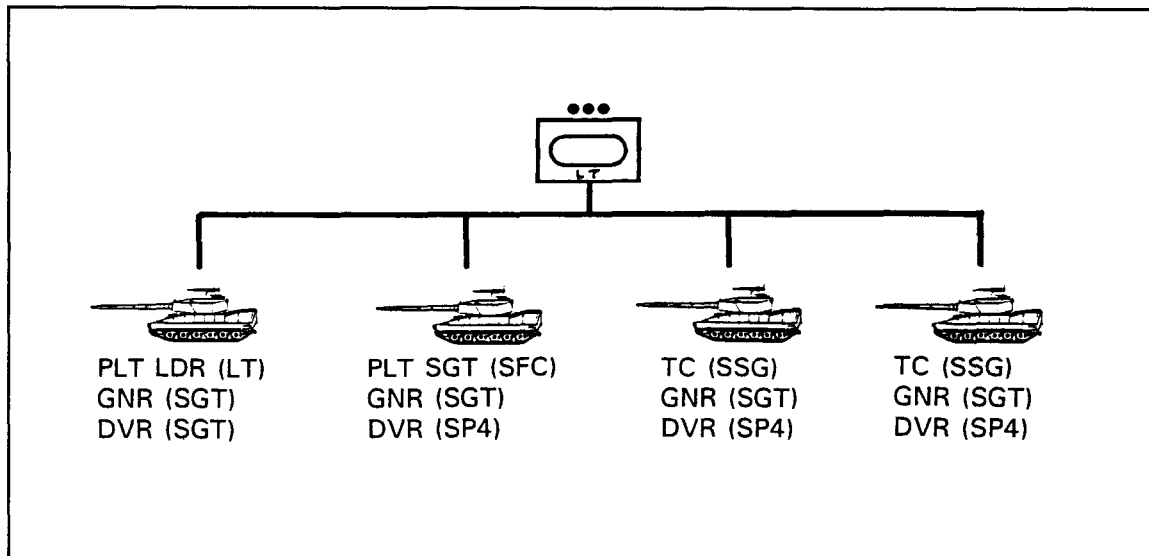

Figure 4-1. Light armor platoon.

## LIGHT BATTALIONS

Characteristics of the battalion vary by the type of light force. Some important generalizations can be made.

**Light Infantry Battalion.** This is the most austere conventional combat battalion; of the three types of battalions described here, its organization differs most from that of the light armor battalion. This battalion has only three rifle companies and a headquarters company. The differences among this battalion and air assault and airborne battalions are greatest in the organization of support and logistics. The battalion has no trucks larger than its 27 cargo high-mobility multipurpose wheeled vehicles (HMMWVs). There is no mess team in the battalion; Class I supply is prepared by brigade. There is only one mechanic in the entire battalion; repairs are conducted at brigade level. The battalion has only 18 long-range radios. The light infantry battalion has limited antiarmor capability: a HMMWV-mounted tube-launched, optically tracked, wire-guided missile (TOW) platoon at battalion level and a Dragon (Javelin) section at company level.

**Air Assault Battalion.** The air assault battalion and the airborne battalion are similarly organized with three rifle companies, an antiarmor company, and a headquarters company. Tactical movement for both usually is a combination of air insertion and foot marches. A major difference, however, is in the number and types of wheeled vehicles in the air assault battalion. The battalion has six 5-ton cargo trucks and 45 HMMWVs. There is a mess section and a 17-person maintenance platoon. Communications are served by 29 long-range radios. Antiarmor capability of the line company is decentralized down to each rifle squad.

**Airborne Battalion.** Once inserted, the airborne battalion tactically performs much like a light infantry battalion; walking is a principal means of transportation. It does have 10 2-1/2-ton trucks and 36 cargo HMMWVs, and it can move nontactically by truck. It has a mess section and a 16-member maintenance platoon. The airborne battalion has 30 long-range radios. Its rifle squads also have antiarmor capability.

## AUGMENTATION

The light armor platoon requires nearly the same CS and CSS as the light armor company. Because this may not be routinely possible, light armor platoons may have to fight with degraded maintenance, medical evacuation, and Classes III and V support. When task organized to a light battalion, the light armor platoon should be augmented in those areas, based on the type of light battalion and the battalion's augmentation from higher headquarters. Table 4-1 shows sources for augmentation.

Table 4-1. Sources for augmentation.

Possible Augmentation	Provided by
HMMWV for C2	Parent light armor company or battalion
Maintenance team (HMMWV with tools and parts boxes)	Parent light armor company or battalion
Ammunition section (5-ton truck)	Parent light armor battalion
Fuel section (5-ton truck)	Parent light armor battalion
Supply section (5-ton truck with water trailer)	Parent light armor battalion

## Section II. Employment

### PLATOON MISSIONS

The primary missions of the light armor platoon are to move, attack, and defend. It may take on additional tasks related to accomplishing its primary missions. The platoon operates as part of a light armor company or task organized to a light infantry battalion TF. Figure 4-2 shows the light infantry battalion's typical missions and the light armor tasks that may be required. When task organized to light infantry, the light armor platoon generally performs in two ways. First, the platoon may be employed as the primary maneuver element. Second, it may be in a direct FS role when infantry is the primary maneuver element. The decision of which role is used depends on METT-T. The light armor platoon also may be used as a separate special platoon, or it may be attached to one of the light companies in direct support (DS). This chapter will address the concerns of the light armor platoon leader under such conditions.

The platoon is the first level where the light armor unit leader must be trained to interact with a light infantry controlling headquarters staff. Further, the platoon leader must simultaneously act as the light armor force advisor to the battalion commander; he must rely on the staff for immediate CS and CSS. If the light armor platoon's company commander or XO is in the vicinity of the sector or zone, some assistance may be coordinated through that commander; however, this is not a certainty.

### OPERATIONAL PLANNING CONSIDERATIONS

**Intelligence.** Assignment of a light armor platoon gives a light infantry battalion a number of stabilized thermal sight systems. The light armor platoon can assist with screen missions in conjunction with the battalion's scout platoon or antiarmor company/platoon.

The light infantry S2 may not be aware of the IPB needs of the light armor platoon; therefore, the light armor platoon leader should ask the battalion S2 for the following: the

number of enemy forces; the armor protection level and armor-piercing capability of enemy forces; and terrain analysis requirements for mobility corridors. Potential NBC threat targets that may affect the platoon are identified by the battalion chemical officer.

**Maneuver.** The primary uses of the light armor platoon will be as a maneuver element or direct FSE for light infantry. Light infantry/light armor operations normally use one of four methods of maneuver refer to pages 4-41 through 4-44 for further information).

- The light armor force attacks by fire while the infantry infiltrates and assaults the objective.
- Light armor attacks by fire while light infantry advances for the assault. The light armor force then joins in the assault.
- The light armor and light infantry forces approach the objective on different axes.
- Light armor and light infantry forces advance together.

Light Infantry Battalion Mission/Task	Light Armor Platoon Tasks
Movement to Contact	Overwatch Attack by fire Provide mutually supporting fire Screen Provide direct fire suppression Reserve Counterattack
Attack	Maneuver as lead force Provide suppressive fires Counterattack Attack by fire Isolate an objective Security during consolidation Deceive enemy Screen Support or assault during breach Exploitation force
Defend	Deceive enemy Screening force Security force Reserve Counterattack Cover obstacles with long range direct fires
Delay	Overwatch Counterattack by fire Deception Reinforce Reserve Counterattack force

Figure 4-2. Battalion missions and platoon tasks.



Withdrawal	Screening force Deceive the enemy Fix enemy attack Detachment left in contact (DLIC) Rear guard Reserve
Raid	Deception Attack by fire Secure exit routes Fix enemy force
Passage of Lines	Overwatch Reserve

Figure 4-2. Battalion missions and platoon tasks (cont).

**Fire Support.** FS internal to the battalion consists of an 81-mm mortar platoon and 60-mm mortar sections in each rifle company. Calls for FS are by voice only. Light infantry battalions are usually supported by a towed 105-mm howitzer battalion. The light armor platoon may receive priority of fires during any phase of the operation.

Calls for fire within the company boundary may be cleared by the company FIST. Consideration must be made for friendly dismounted infantry operating in the same area. The light armor platoon must observe all identified targets and fires to avoid fratricide.

Smoke can be used effectively in the environment that light armor platoons will most likely operate in. Light armor crews can maintain target detection capability through smoke by using their thermal sights. Dismounted enemy forces will probably not have this capability.

**Air Defense.** Light armor platoons, which may not have dedicated Stingers or Avengers, conduct passive air defense techniques continuously. When moving in a light infantry battalion's AO, the light armor platoon will generate the largest signature from the air. Unlike armored maneuver battalions, the light armor platoon may be the only mechanized vehicles in the area and therefore becomes a lucrative target for enemy aircraft. Coordination should be made by the battalion staff to increase the ADA alert posture when the light armor platoon moves.

**Mobility and Survivability.** Engineer battalions possess a variety of earthmoving equipment, including armored combat earthmovers (ACE), lightweight, high-speed bulldozers, small emplacement excavators (SEE), dozers, and scoop loaders. The battalion commander assigns a priority of engineer effort. Light armor platoons may be given priority of effort, particularly in the defense. Two-tier fighting positions will normally require corps engineer support.

The obstacle plan must be deconflicted with any counterattack or withdrawal plan that the light armor platoon may execute. This must be done early in the planning stages by the battalion staff or through face-to-face coordination between the engineer platoon leader and the light armor platoon leader.

**Combat Service Support.** The light armor platoon must sustain itself under austere logistical conditions. The light armor platoon leader and platoon sergeant will do much of the logistical coordination directly through the battalion staff during the early stages of

contingency operations. Chapter 8 of this manual describes these unique logistical support processes in detail.

In most cases, Class III will be the most critical logistical concern for the light armor platoon during the initial stages of a contingency operation. Movement should be carefully planned to conserve fuel. Fuel distribution may be prioritized by the battalion commander to provide fuel for combat systems such as the M8.

**Command and Control.** In many cases, the light armor platoon leader acts as the battalion commander's principal advisor on the employment of the light armor platoon. He must accurately convey the capabilities and limitations of the platoon to the commander to maximize the effectiveness of the platoon. The platoon leader acts as a key staff member during the planning process at battalion level until the commander, XO, or LO from the light armor battalion staff becomes available to assist. Likewise, platoon sergeants and vehicle commanders will become advisors to light infantry company commanders if the platoon is task organized accordingly.

The platoon leader will normally communicate on the battalion command net unless attached to a light infantry company. The maneuverability of the light armor platoon can make the platoon the most lethal and effective ground reaction force for the commander. Therefore, leaders must stay abreast of the tactical situation of the battalion at all times to provide timely response if called upon to react to a threat in any part of the AO.

### Section III. Command, Control, and Communications

The platoon is organized in two sections. The platoon leader (M8 #1) and platoon sergeant (M8 #4) are the section leaders. M8 #2 is in the platoon leader's section, and M8 #3 is in the platoon sergeant's section. There may be instances, such as during convoy security or operations in a BUA, where the sections will operate independent of each other to support the light infantry commander.

The wingman concept facilitates C2 of the platoon. It requires that one M8 orient on another M8, on either the left or the right (see Figure 4-3). M8 #2 orients on the platoon leader's vehicle, M8 #3 on the platoon sergeant's, vehicle and the platoon sergeant's M8 on the platoon leader's vehicle. In the absence of specific instructions, wingmen move, stop, and shoot when their leaders do. Distances between vehicles should not be less than 50 meters or more than 100 meters as a basic guideline. This is dependent on METT-T and may be difficult in very close (jungle) or very open (desert) terrain.

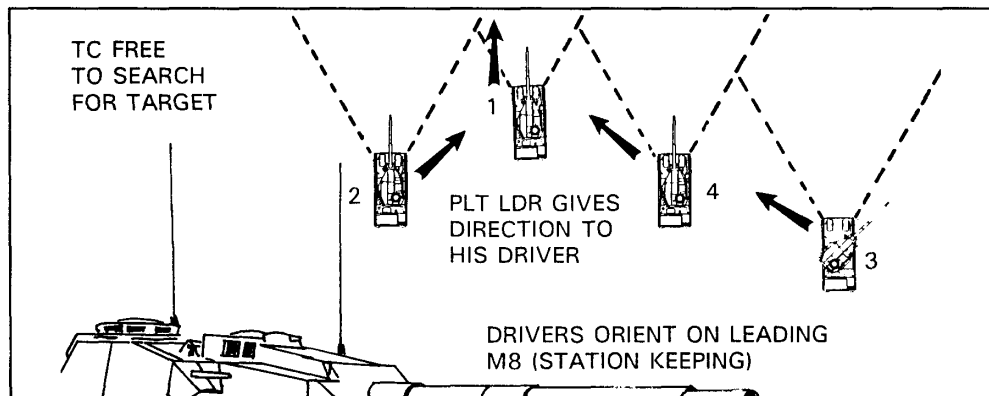

Figure 4-3. Wingman concept.

## TACTICAL COMMUNICATIONS

The platoon leader is responsible for the planning, maintenance, training, and use of communications systems within the platoon. He is also responsible for operating within the company or battalion communications network.

The platoon leader can choose from several different communications means: messenger, wire, visual, sound, or radio. These means should complement each other so the platoon does not depend on only one. Dependence on one means endangers C2, while reliance on several strengthens that control.

**Messenger.** TMs is the most secure means available and is the best means for transmitting lengthy messages. A messenger should be used to deliver platoon fire plans and status reports. During movement halts, all messages delivered by messenger should be written.

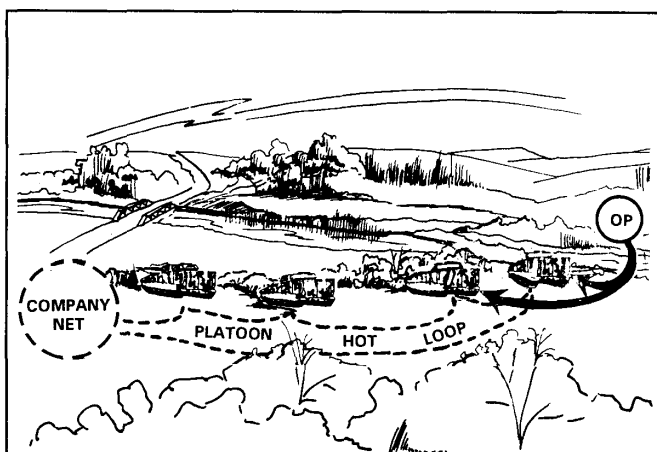

Figure 4-4. The platoon hot loop.

**Wire.** The platoon hot loop allows each vehicle to communicate with the platoon leader by wire. OPs and company CPs may also be connected to the hot loop (see Figure 4-4). It can be used in initial defensive positions, assembly areas, or other static situations. The hot loop is formed by connecting wire between the line terminals on the AM-1780 of each vehicle. The main power switch on the AM-1780 is then placed in the INTERCOM ONLY position, and all CVC helmet control switches are placed in the center position. The control box at each crew member's position should be placed in the ALL position.

Field telephones can then be connected at any point in the line to communicate within the hot loop. The M8 can be connected to the hot loop at the external phone when the driver's control box is in the EXT position. Field telephones can also be connected directly to the AM-1780 by using a length of WD-1 wire. This allows the platoon leader to communicate with an OP, an infantry company, or platoon CP without establishing a hot loop.

**Visual.** Visual communication is used to transmit messages and to identify friendly forces. Visual signals are of little use when visibility is poor or when a sufficient line of sight is not available. When working with infantry, leaders use hand-and-arm signals to control vehicle and platoon movements. The discussion of formations later in this chapter illustrates hand-and-arm signals.

Messages can be sent with flags by using prearranged signals. Each vehicle has three flags: red, green, and yellow. They can be used to—

- Control movement. Flags serve as an extension of hand-and-arm signals when the distance between vehicles becomes too great.
- Mark vehicle positions. For example, a quartermaster party member may use flags in an assembly area to mark vehicle positions.

- Identify disabled vehicles.
- Warn friendly elements of an advancing enemy. For example, an OP uses a flag to signal a platoon to move to its fighting position.
- Signal the supporting light armor element to shift or cease fires on an objective.

Based on signals established in the unit SOI or by the commander, flashlights and other lights may be used to transmit brief prearranged messages (for example, to identify friendly units).

Pyrotechnic ammunition can be used to illuminate an area at night or as a signal. It is available in several types and colors. These signals are generally used for friendly unit identification, maneuver element control, target marking, and location reports. They can also be used for ground-to-air communication. Their main advantage is the speed information can be transmitted to a large number of troops and isolated units. Meanings for these signals should be brief, simple, and based on SOP. Colors used in combinations or series increase the chance of error; observers may be unable to distinguish different colors or may miss part of a series. Pyrotechnic messages should be confirmed quickly by another communications means so the originator can be sure they were seen and understood. Pyrotechnic signals are easily imitated by the enemy and cannot be fully trusted unless the signaler can be identified. Since these signals can also be seen by the enemy, security must be considered to avoid exposing friendly unit locations or intentions.

Panels are used for communicating with aircraft to mark landing areas, DZs, and positions and to identify units as friendly. Identification displays are described in the SOI, SOP, or OPORD.

**Sound.** Whistles, horns, sirens, bells, voice amplifiers, and explosive devices can be used for audible (sound) communications. They are used to attract attention, transmit prearranged messages, and spread alarms. The range and clarity of sound signals are greatly reduced by battle noise. Since they are open to enemy interception, sound signals may be restricted for security reasons. They must also be kept simple to avoid misunderstandings.

**Radio.** The radio is the platoon's most flexible, but least secure, means of communication. It can quickly transmit information over long distances with great accuracy. Without secure equipment, however, radio signals are vulnerable to enemy interception. The platoon uses the radio only when other means of communication cannot be used. Each vehicle is equipped with a voice radio, and all vehicle commanders of the platoon monitor the platoon net. The platoon leader and platoon sergeant also monitor the company net. Each platoon vehicle has a single channel ground and airborne subsystem (SINCGARS) radio with either an internal secure voice system or VINSON security system.

The use of standardized call signs can reduce confusion in emergency conditions, such as when enemy contact has been made or when SOI procedures would adversely affect C2. An example of standardized call signs is the use of RED, WHITE, and BLUE to signify 1st, 2d, and 3d platoons.

## FORMATIONS

Formations are used to establish M8 positions and sectors of responsibility during operations. Formations facilitate control; increase protection, speed, and fire effectiveness; and alleviate confusion. Formations are not intended to be rigid; vehicles are not expected to be a specific distance apart. Position of each M8 in the formation depends on the terrain and the wingman driver's ability to see the lead vehicle.

## FM 17-18

Individual vehicles should move in the same relative position within the formation. This will ensure that each crew knows where to move, who is behind them, and where to observe and direct fires. Gun tube orientation for rear and flank vehicles should be modified to ensure 360-degree security based on the position of the platoon within the parent unit formation. The seven basic formations for the platoon are—

- Wedge.
- Vee.
- Echelon.
- Line.
- Column.
- Coil.
- Herringbone.

**Wedge.** The wedge is employed when a platoon is provided overwatch by another element and terrain is open or rolling (see Figure 4-5). It is normally used when the enemy situation is vague and contact is imminent.

The wedge has these advantages:

- It permits excellent fire to the front and good fire to each flank when leading infantry formations.
- It allows platoon leaders excellent observation up front while being covered by their wingmen.
- It enhances control since leaders are in close contact and can easily relay hand-and-arm signals to each other and any following infantry formations.

The wedge has these disadvantages:

- It requires lateral space for movement; therefore, it is difficult to use in closed terrain with dismounted infantry.
- It may expose the entire platoon to enemy fire simultaneously.

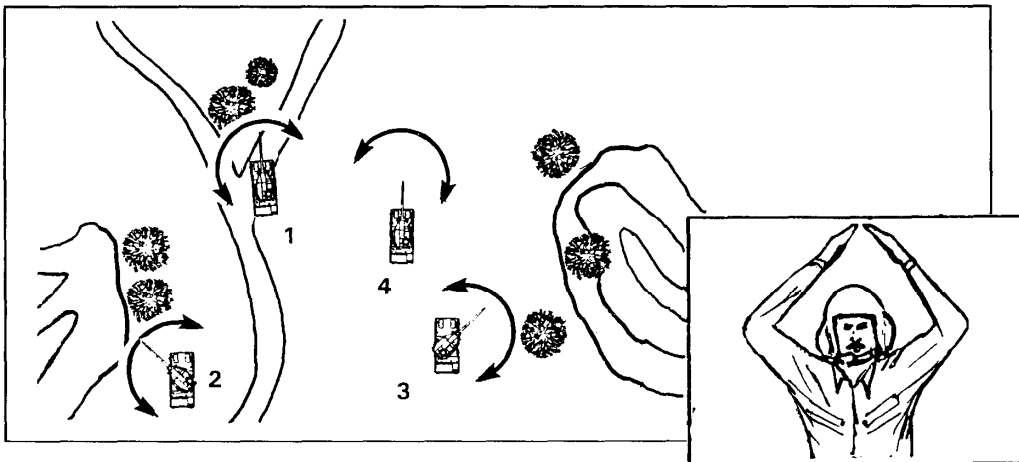

Figure 4-5. Wedge formation.

**Vee.** The platoon leader and his wingman lead, followed by the platoon sergeant's section. This formation is used when weather or terrain restricts movement or when overwatch within the platoon is required (see Figure 4-6).

The vee has these advantages:

- It provides excellent protection.
- It provides excellent control.
- It facilitates rapid deployment to any other formation.

The vee has these disadvantages:

- It limits fires to the front.
- It is more difficult to maintain orientation than in a wedge.
- It provides less control in wooded areas.

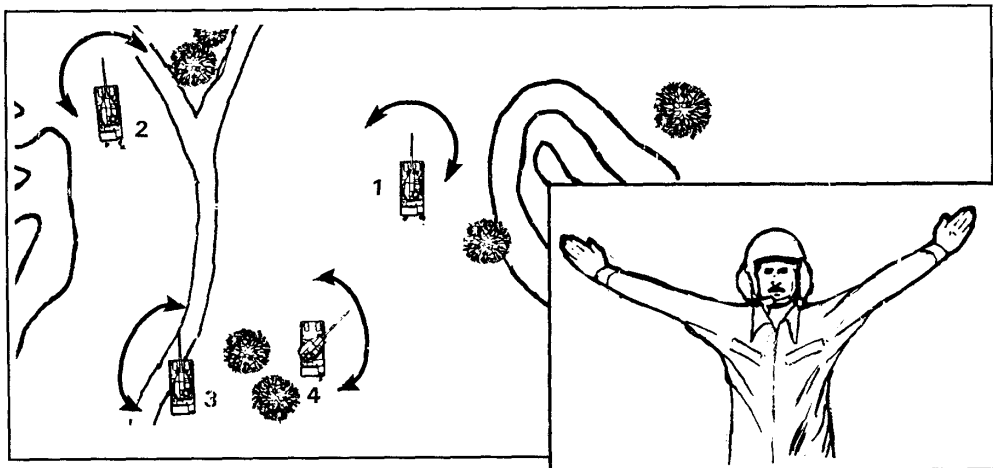

Figure 4-6. Vee formation.

**Echelon.** The echelon is used to screen an exposed flank of a larger moving force or the platoon (see Figure 4-7). It is also used when a light infantry unit faces a significant flank threat, such as when it is bypassing a strongpoint or BUA.

Echelons have these advantages:

- They provide excellent firepower to the front and one flank.
- They provide the best security to the higher unit formation.
- They facilitate rapid deployment perpendicular to the direction of movement.

The echelon has these disadvantages:

- It is difficult to control in wooded terrain.
- It is difficult to integrate into an infantry formation.

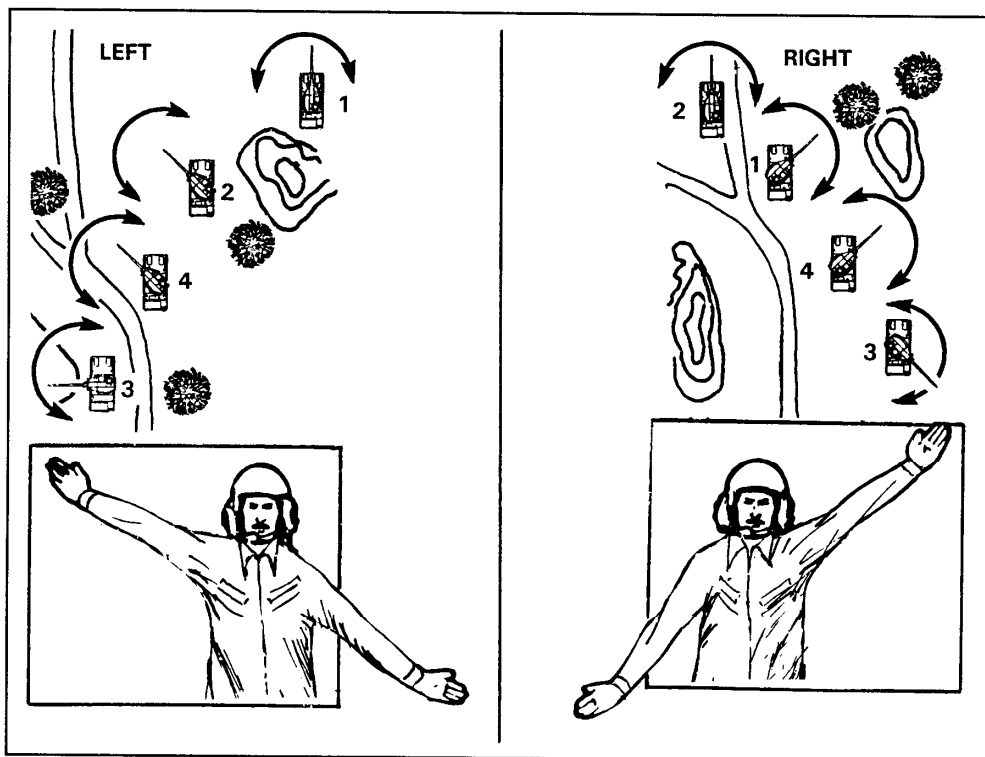

Figure 4-7. Echelon left and echelon right formations.

**Line.** A line formation is used to cross dangerous areas and assault a position (see Figure 4-8). It also facilitates mutual support when emerging from limited visibility conditions such as smoke or heavy woods.

The line has these advantages:

- It provides excellent firepower forward.
- It provides protection to dismounted infantry.
- Maximum vehicles can close on an objective in minimum time.

The line has these disadvantages:

- It provides minimum fire to flanks.
- It is less secure than other formations because of lack of depth.
- It is the most difficult to control.

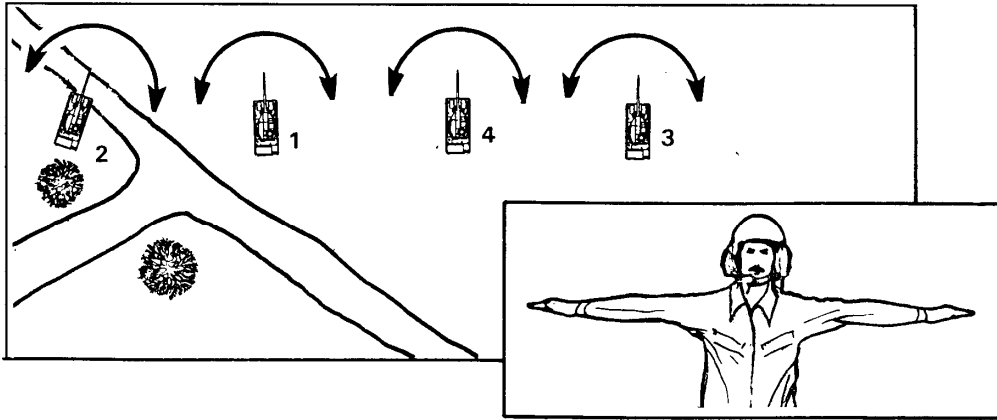

Figure 4-8. Line formation.

**Column/Staggered Column.** In these formations, the platoon leader positions himself where he can best control his elements. If he does not lead, he must ensure the lead vehicle commander is thoroughly familiar with the route of march and direction of travel. The column is used in night movements, in fog, when passing through defiles or dense woods, and during road marches when speed is required. The staggered column is used when terrain allows for dispersion (see Figure 4-9).

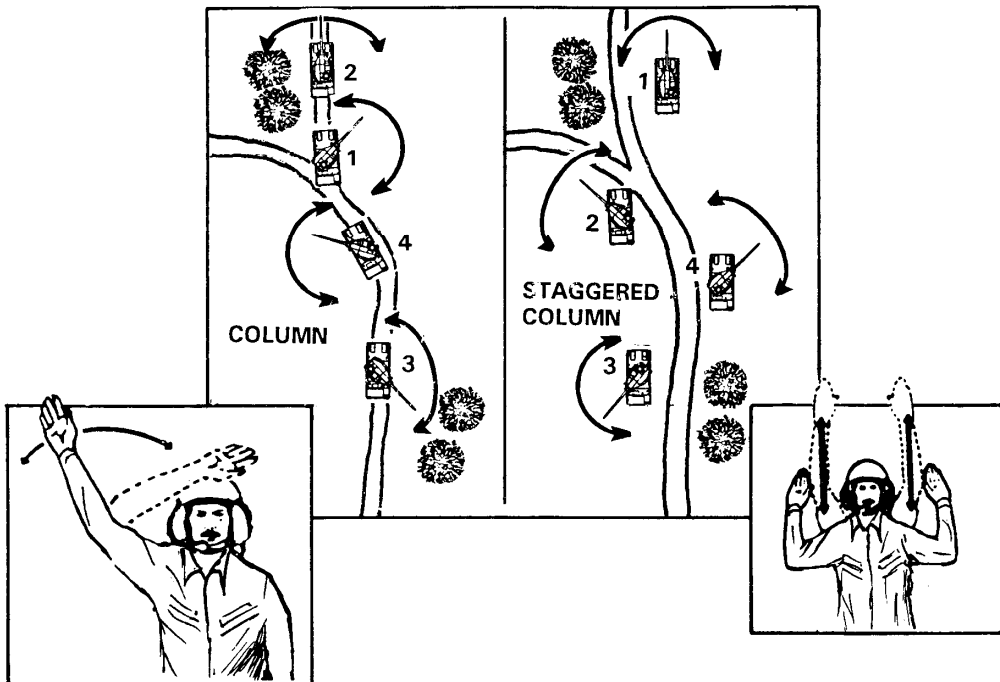

Figure 4-9. Column and staggered column formations.



The column or staggered column has these advantages:

- It provides excellent control.
- It provides excellent firepower to the flanks.
- It facilitates rapid deployment to other formations.
- It facilitates rapid movement.
- The dispersion increases security against enemy air and artillery attack.

A disadvantage of the column and staggered column is that they allow little fire to the front.

**Coil.** The platoon can employ this formation when it is operating independently and experiences extended halts or lulls in combat (see Figure 4-10). The platoon leader positions his M8, and the remaining tank commanders position their M8s based on the terrain.

The coil has these advantages:

- It provides good all-around security.
- It facilitates expanding to a perimeter defense.
- It provides protection to light infantry in open terrain.

A disadvantage of the coil is that without infantry it offers only limited security in heavily wooded terrain.

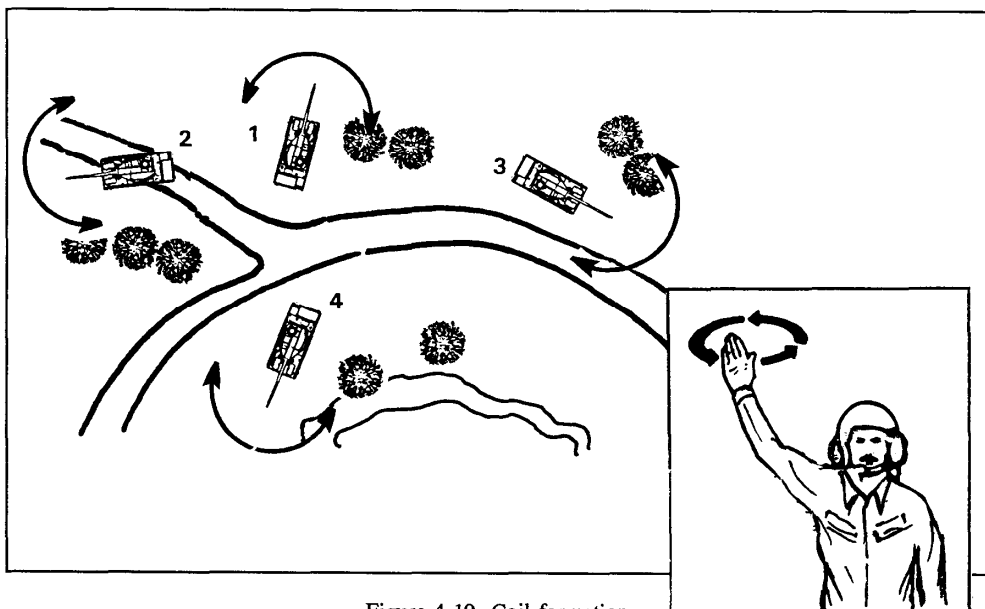

Figure 4-10. Coil formation.

**Herringbone.** The platoon uses this formation when it assumes a hasty defensive posture or temporary halt on a road where terrain does not allow adequate off-road dispersion. Vehicles move off the road if terrain permits (see Figure 4-11). Infantry should dismount and seek cover and concealment while providing additional security and observation.

The herringbone has these advantages:

- Vehicles can pass through the center of the formation.
- It facilitates dismounting of infantrymen prior to further deployment of the armor platoon.

The herringbone has these disadvantages:

- Vehicles may be vulnerable to enemy air attack.
- Security is limited (without infantry) and terrain does not allow for dispersion.

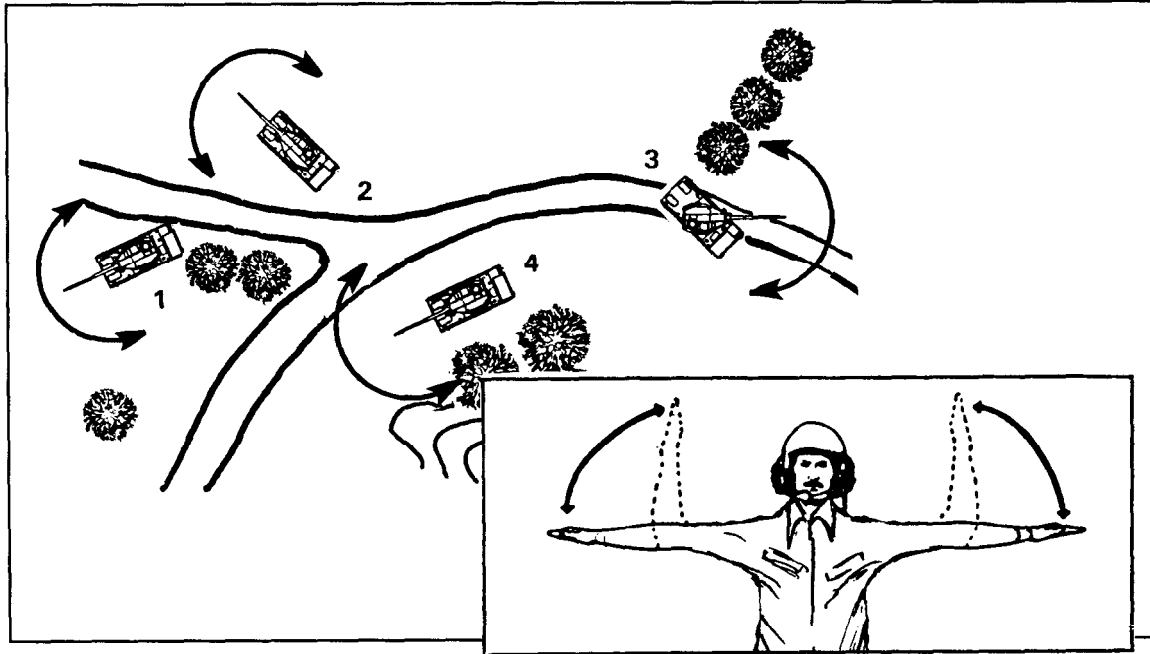

Figure 4-11. Herringbone formation.

## DIRECT FIRE CONTROL

M8 fires must be properly distributed and controlled to effectively support any operation, especially in close proximity to light infantry. In most cases, this is accomplished by the vehicle commanders following established unit SOPs and direct fire plans. Occasionally, the platoon leader will be in position to direct the fires of the entire platoon.

**Platoon Fire Plan.** The platoon fire plan provides the platoon leader with the necessary information to distribute and control the fire of all available direct and indirect weapons. The fire plan assists the platoon leader in determining how well the platoon has covered its assigned sector and in deciding which vehicle should move if shifts are required.

**Control Measures.** The dynamics of the offense will normally require that fires be controlled using the radio. Alerts and commands must be brief. Engagements will normally be initiated by the M8 crew that sees the enemy. During defensive operations, visual control measures can be used to start and stop engagements, shift fires, and signal prearranged actions.

**Engagement Priorities.** An M8 should always engage the most dangerous threat first. During offensive operations, the most dangerous threat will be the enemy antitank weapon systems. During defensive operations, platoons have more freedom of choice concerning what to engage and when to begin engagements. The platoon leader should control M8 fires so enemy C2 vehicles are engaged first. He can do this by assigning a vehicle or section the mission of observing for the C2 vehicles. Once they are acquired, the platoon leader initiates the platoon engagement.

**Fire Patterns.** Three basic fire patterns will cover most situations and provide fast, effective fire distribution. No matter which method of engagement is used, the goal is to engage near and flank targets first, then shift fires to the center and far targets. Fire patterns are particularly effective when all vehicles can see all of the enemy in the EA. The basic fire patterns are described in the following paragraphs.

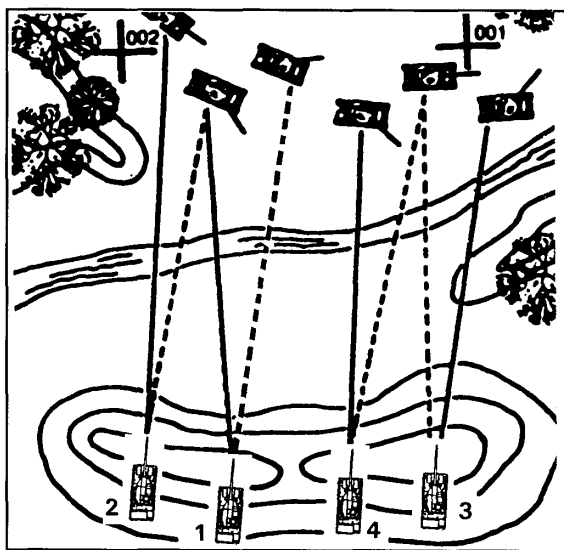

Figure 4-12. Frontal fire.

**Frontal Fire.** Frontal fire is used when the enemy is dispersed laterally in relation to the platoon and all M8s are firing to the front. The left-most vehicle engages the left-most target, and the right-most vehicle engages the right-most target. The two center vehicles engage targets to their direct front. When targets are destroyed, fires are shifted toward the center of the enemy formation (see Figure 4-12).

**Cross Fire.** Cross fire is employed when the enemy is exposed laterally but obstructions prevent all vehicles from firing to the front. The left-most M8 engages the right-most target, and the right-most M8 engages the left-most target. The two center M8s engage targets diagonal to their own positions. When targets are destroyed, fires are shifted toward the center of the enemy formation (see Figure 4-13).

**Depth Fire.** Depth fire is used when the enemy is exposed in column. The left-most M8 engages the rear target, then shifts toward the center. The M8 second from left engages a center target, then shifts toward the rear. The right-most M8 engages the front target, then shifts toward the center. The M8 second from right engages a target in the center and shifts toward the front of the enemy (see Figure 4-14).

**Techniques of Fire Control.** In addition to employing fire patterns to distribute fires, platoon leaders may choose one of three firing techniques to control the direct fires of their units:

- **Simultaneous fire.** This is the primary firing technique used by the platoon. It is employed during most offensive engagements when the unit encounters surprise targets. It is also used in most defensive engagements when the enemy array is numerous enough to require multiple engagements by each M8 in the unit.

- Alternating fire. Alternating fire is normally used when the platoon is in a defensive position or is undetected. Each vehicle alternates firing and observing with its wingman. Subsequent fire, by command, is simultaneous. During alternating fire, the wingmen are normally the first vehicles to fire. The platoon leader and platoon sergeant provide observation, then fire. The process continues until all targets are destroyed or the leader switches to simultaneous fire.
- Observed fire. This is normally used when the platoon is in protected defensive positions and engagement ranges are in excess of 2,000 meters. The first vehicle to fire engages while the wingman observes. This technique allows for maximum observation and assistance while protecting the location of the observing vehicle. The observer vehicle must remain prepared to engage in the event the firing vehicle consistently misses, experiences a malfunction, or runs low on ammunition.

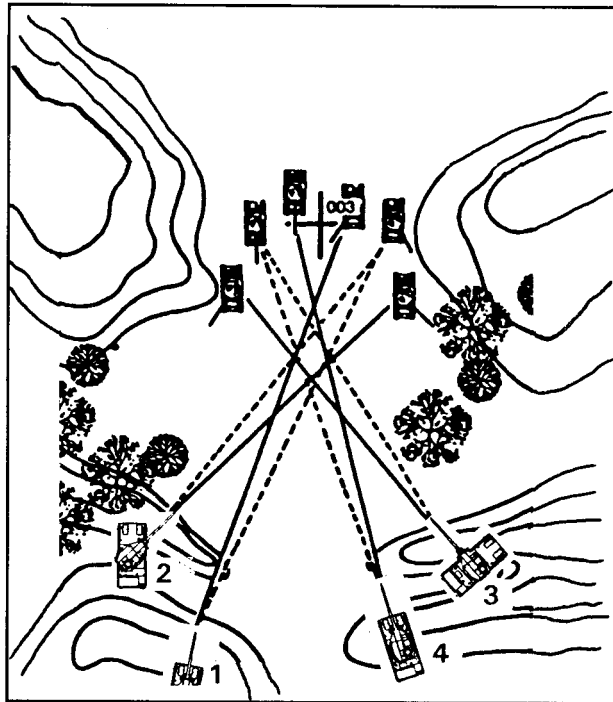

Figure 4-13. Cross fire.

## Section IV.

### Offensive Operations

#### DIRECT FIRE PLANNING

The platoon offensive fire plan establishes how direct fires will be used to support movement or other actions during an operation (assault or support by fire, for example). The platoon leader considers the following factors when developing his plan:

- Enemy situation.
- Friendly situation.
- Platoon's mission.
- Commander's scheme of maneuver and plan for FS.
- Ammunition status and plan for resupply.
- Special signals and communications to be used.

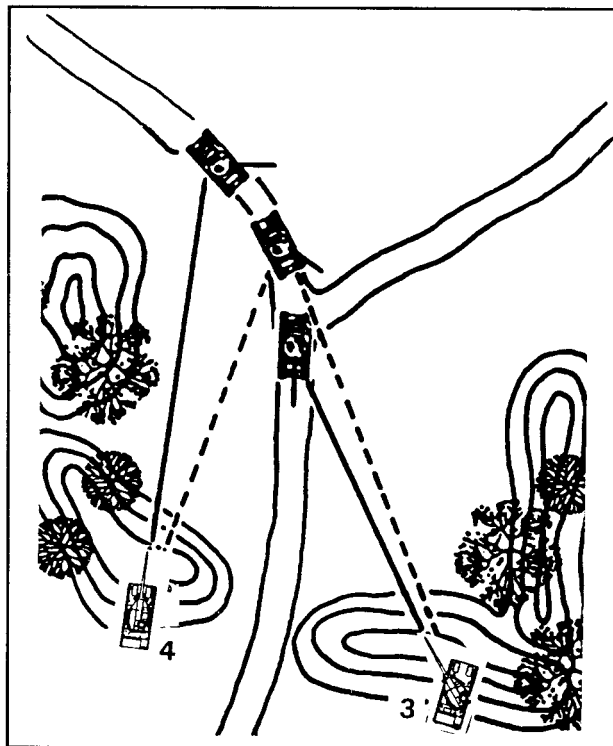

Figure 4-14. Depth fire.

The following issues should be addressed in the plan:

- Engagement of known enemy positions.
- Use of fire or smoke to conceal or cover movement.
- Any support by fire missions.
- Graphics used to control fires.
- Engagement techniques or fire patterns if different from unit SOP.

## TECHNIQUES OF ENGAGEMENT

The platoon uses one of three techniques to engage enemy forces.

**Assault.** Assault fire is employed when the platoon is assaulting the enemy. All weapons are used in assault fire.

**Support by Fire.** Support by fire is used to kill or suppress an enemy position while other elements move, assault, or withdraw. The platoon leader can direct the intensity of fire in his OPORD, or he may have to determine the intensity during the operation.

When delivering supporting fire, the platoon can expect to draw enemy return fire. Hull-down positions are desirable, and firing vehicles should alternate firing positions.

**Surprise and Ambush Fires.** In the offense, targets can appear on the battlefield without warning. These targets must be immediately engaged and destroyed to maintain momentum. Platoon battle drill procedures provide for positive action when such targets appear. The first vehicle to observe surprise targets engages them immediately. All vehicles in the same section or platoon then join in the engagement. The remaining platoons provide suppressive fire or move to support the engaged platoon.

## MOUNTED MOVEMENT

**Techniques of Mounted Movement.** The following are the primary mounted movement techniques:

- **Traveling.** Traveling is characterized by continuous movement of all elements and is best suited to situations where enemy contact is unlikely and speed is important. This is the most likely technique when infantry rides on the M8.
- **Traveling overwatch.** Traveling overwatch is an extended form of traveling that provides additional security when contact is possible but speed is desired. The lead element moves continuously. The trail element moves at various speeds and halts periodically to overwatch the movement of the lead element. The trail element maintains a minimum distance of 500 meters, depending on terrain, to permit movement in case the lead element is engaged.
- **Bounding overwatch.** Bounding overwatch is used when contact is expected. It is the most secure and slowest movement technique. There are two methods of bounding:
  - **Alternate bounds.** The lead element halts and assumes overwatch positions. The rear element advances past the lead element and assumes overwatch positions. The initial lead element then advances past the initial rear element and assumes overwatch positions. Only one element moves at a time. This method of bounding is usually more rapid than successive bounds.

- Successive bounds. In this method, the lead element, covered by the rear element, advances and assumes overwatch positions. The rear element advances to a position abreast of the lead element, halts, and occupies overwatch positions. The lead element then moves to the next position. Only one element moves at a time, and the rear element does not advance beyond the lead element. Successive bounding is easier to control and more secure than alternating bounds.

**Oversight.** When light armor elements are given the task to overwatch, they should occupy positions that offer cover and concealment, good observation positions, and clear fields of fire. Elements occupying overwatch positions should—

- Visually check the security of the positions.
- Occupy hull-down firing positions.
- Assign sectors of fire.
- Orient weapons on likely or suspected enemy positions.
- Search for targets (see Figure 4-15).
- Use thermal sights to find heat sources not visible to the naked eye. Thermal signatures may reveal vehicles or troops in tree lines or wooded areas; towns or villages; depressions; or potential observation points, such as church steeples, silos, or hilltops.

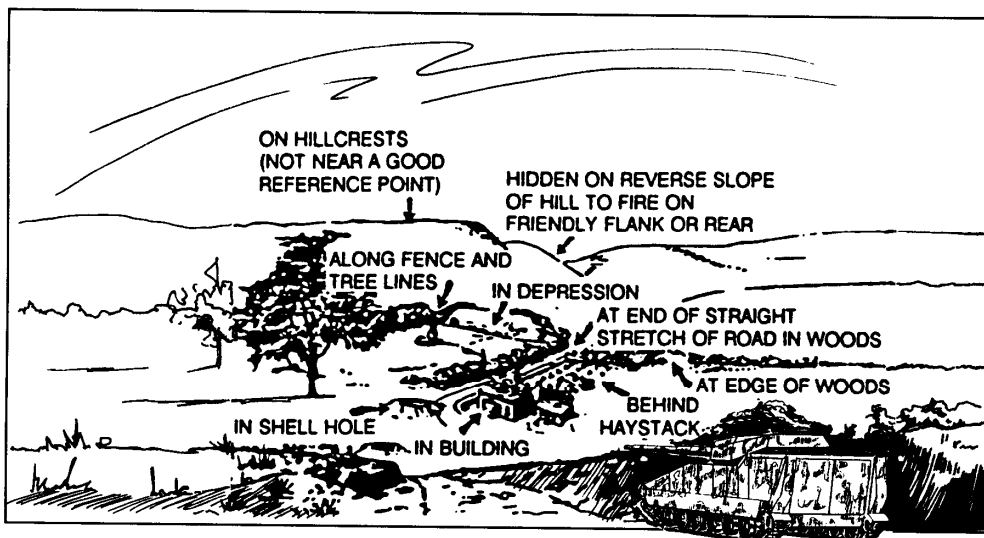

Figure 4-15. Searching for potential targets.

## BASIC LIGHT INFANTRY MOVEMENT TECHNIQUES

Because light armor works in close proximity with light infantry, the light armor platoon leader must understand the basic movement techniques of the infantry squads that will move forward, behind, and on the flanks of his platoon.

**Traveling.** Squad members form into two wedges, one behind the other, when the terrain allows (see Figure 4-16). When the terrain and/or visibility is very restricted, the squad may travel in a column by fire teams. The trail fire team follows at approximately 20 meters behind the lead team. Squad members move approximately 10 meters apart.

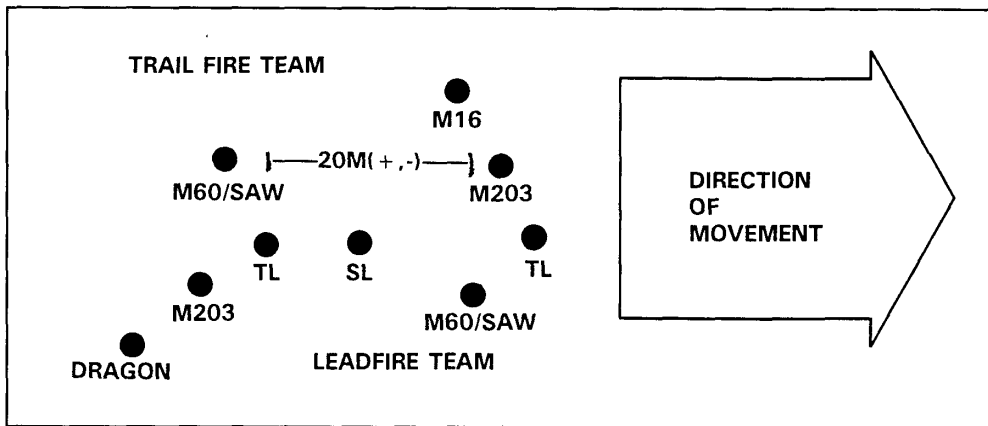

Figure 4-16. Traveling.

**Traveling Overwatch.** The traveling overwatch technique (see Figure 4-17 essentially the same as the traveling technique. The distance between wedges (fire teams) increases to approximately 50 meters to allow the trail team to overwatch the lead team.

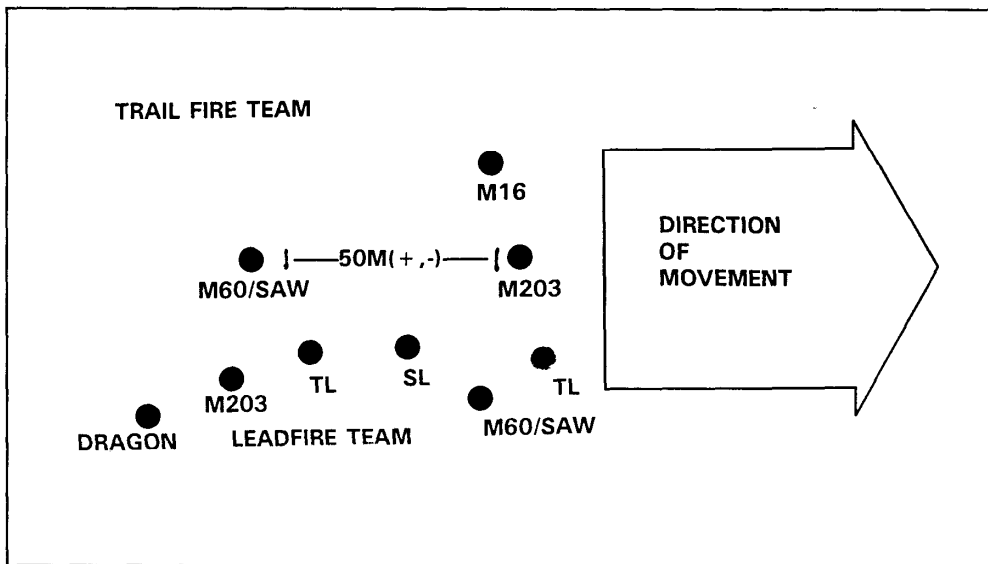

Figure 4-17. Traveling overwatch.

**Bounding Overwatch.** The squad is divided into a bounding team, which moves in a wedge formation, and an overwatch team, which remains in a position to overwatch the bounding team. The squad leader designates the next overwatch position and the route to be used. Bounds must not exceed the observation range of the overwatch team or the maximum effective range of its weapons (see Figure 4-18).

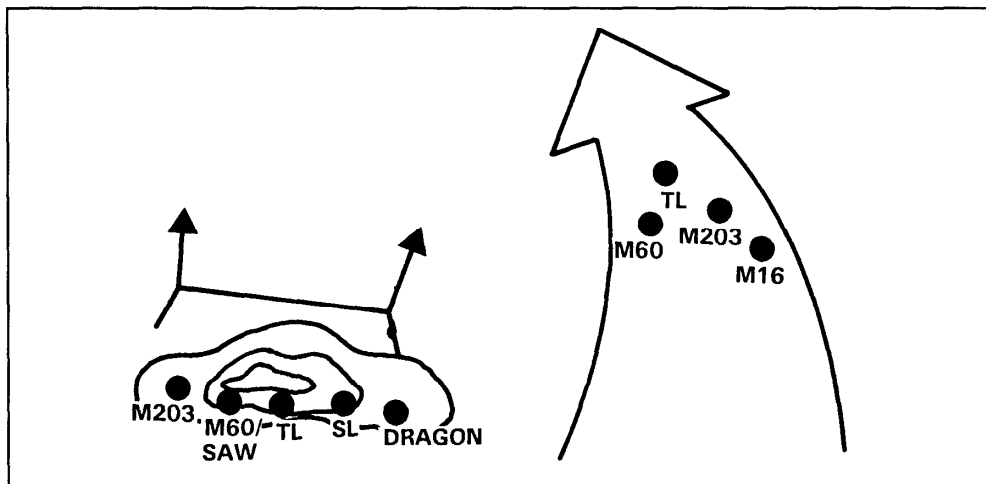

Figure 4-18. Bounding overwatch.

## METHODS OF LIGHT ARMOR/INFANTRY MOVEMENT

When light infantry and light armor move together in any operation, the infantry moves using one of three methods: dismounted, truck-mounted, or M8-mounted.

**Dismounted.** There are two ways dismounted infantry and light armor can move together: armored vehicles lead, followed by the dismounted infantry, or infantry leads and armored vehicles follow.

Movement with vehicles followed by infantry is used when the terrain is relatively open and the infantry has little or no cover and concealment. Moving behind the armor vehicles provides some protection and concealment from enemy small-arms fire.

Dismounted infantry followed by armor is used in restricted terrain when visibility is limited. Infantry provides security for M8s, clearing lanes or zones in front when fields of fire and observation are limited. Considerations for using dismounted movement include the following:

- Speed is reduced to that of dismounted elements. If M8s lead, leaders must guard against leaving infantrymen too far behind.
- Communications between infantry and armor elements can be accomplished through radio, hand-and-arm signals, or the external telephone mounted on the left rear of the M8.
- Prearranged signals (flags, smoke, panels, or hand-and-arm) are coordinated and practiced to ensure close team cooperation.
- Infantry do not move in front of vehicles unless told to do so.



**Truck Mounted.** In some cases, the infantry/armor team may have trucks and HMMWVs from internal or external sources to transport light infantry. This method may be used in several situations:

- When traveling over long distances to a LD.
- When speed is important and outweighs the risk of exposure to enemy fire. Examples include penetration, breakout from encirclement, exploitation, or pursuit.
- When light armor and truck-mounted infantry move together, the armor vehicles usually move in front to provide protection and firepower. One platoon or section may also be placed at the rear of the infantry formation for protection.

**M8 Mounted.** In the light infantry division, some of the infantrymen in the infantry/armor team may be transported on the vehicles. This occurs mostly during a march, exploitation, or pursuit. This method has the advantage of maintaining speed while keeping the infantry and armor together. It also saves infantrymen from fatiguing dismounted marches.

The decision to carry infantry on an armored vehicle requires careful planning. Tactical unity of the infantry and armor teams must be maintained. Infantry leaders should mount armor leaders' vehicles. Usually, an infantry squad (approximately nine infantrymen) can fit on one M8. During planning, each squad should link up with the vehicle it will ride to allow time for the squad and M8 crew to work together and rehearse mounting, dismounting, and action drills.

Infantry platoon leaders should ride armor platoon leaders' vehicles, and infantry platoon sergeants should mount the armor platoon sergeants' vehicles. The infantry leaders should locate next to the vehicle commanders.

The lead M8s should not carry mounted infantrymen. This will allow them to remain free to scan left and right during movement and to return fire immediately if enemy contact is made (see Figure 4-19).

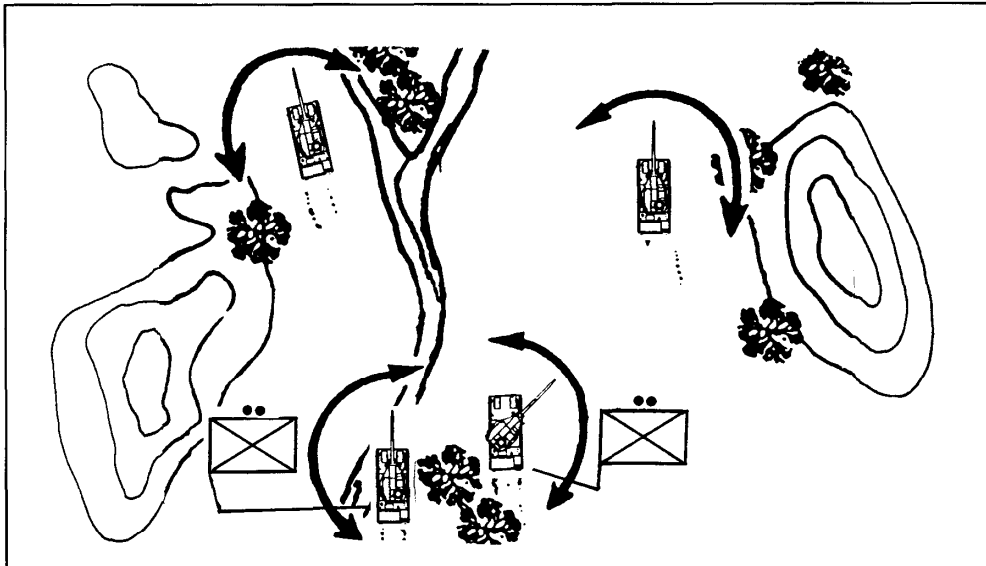

Figure 4-19. M8 formation with mounted infantry.

The following are considerations for infantry and armor leaders when mounting infantrymen on the M8:

- Always alert the M8 commander before mounting or dismounting.
- Follow the commands of the M8 commander.
- Infantry platoons should be broken down into squad-size groups, similar to airmobile chinks, with the infantry platoon leader on the light armor platoon leader's vehicle and the infantry platoon sergeant on the light armor platoon sergeant's vehicle.
- Platoon leaders, platoon sergeants, or team leaders should locate near the vehicle commander's hatch, using the external phone to talk to the vehicle commander and relay signals to the unit.
- M8 crew members must remember that the vehicle cannot return fire effectively with infantry on board.
- Whenever possible, mount and dismount over the left front slope of the vehicle. This ensures the driver sees infantry and that the infantry does not pass in front of the machine guns.
- Passengers must always have three points of contact with the vehicle and watch for low-hanging objects like tree branches.
- Passengers should take the following actions on contact:
  - Wait for the vehicle to stop.
  - Dismount **IMMEDIATELY** on the vehicle commander's command (one fire team on each side). **DO NOT** move forward of the turret.
  - Move at least 5 meters from the vehicle.
- Practice mounting, dismounting, and actions on contact so your team will be trained.
- If possible, the lead vehicle should not carry infantry because it restricts turret movement. Initial contact may also cause casualties among infantrymen mounted on the lead vehicle.
- Infantrymen should search in all directions. They may be able to spot a target the vehicle commander does not see.
- **DO NOT** move in front of vehicles unless ordered to do so.
- **DO NOT** move off a vehicle unless ordered to do so.
- **DO NOT** dangle legs, equipment, or anything else off the side of the vehicle; they could get caught in the tracks, causing death, injury, or equipment damage.
- **DO NOT** overcrowd the vehicle. Falls, bumps, and clogged air intakes can result.
- **DO NOT** fall asleep. The warm engine may induce drowsiness, and a fall could be fatal.
- **DO NOT** smoke when mounted on a vehicle.
- **DO NOT** stand near vehicles during refueling and rearming.
- **DO NOT** stand near a moving or turning vehicle at any time. M8s have a short turning radius.
- Stay clear of the vehicle's canister ejection device. Canisters ejected from main gun rounds can cause serious injury or death.

## FIRE AND MANEUVER

In fire and maneuver, one element maneuvers while another overmatches or supports by fire to suppress or destroy the enemy. Maneuver elements use movement techniques and covered and concealed routes to maneuver to the enemy's flank, maneuver to dominating terrain, or bypass. When the company commander uses one platoon to support by fire, that platoon occupies dominating positions and suppresses the enemy (see Figure 4-20).

**Support by Fire Element.** The company commander designates elements to support by fire while the remainder of the company moves for an assault. The support by fire element's primary mission is to destroy as much of the enemy as possible by long-range fires before the assault. The element uses direct and indirect fires to prevent the enemy from engaging the assault force or from adjusting positions to counter the assault force.

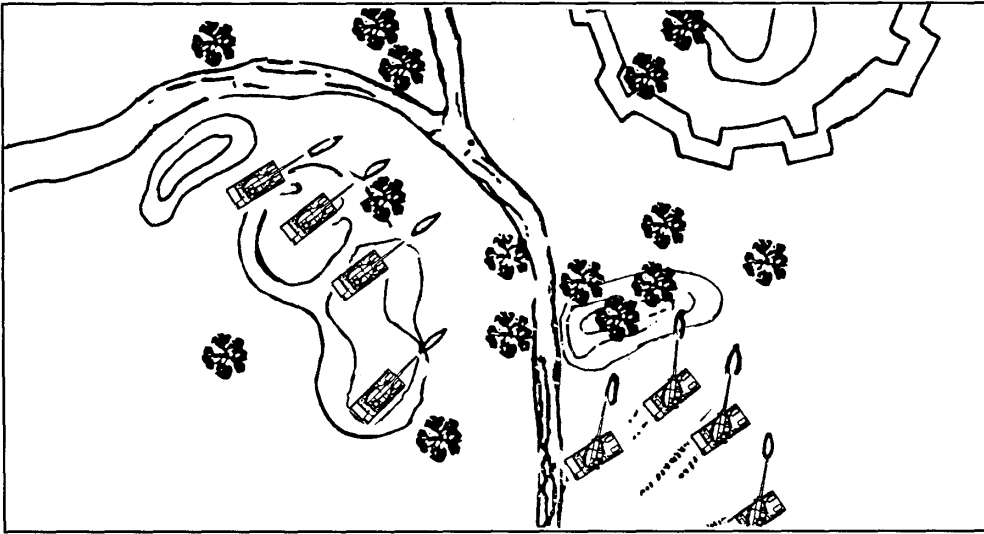

Figure 4-20. Fire and maneuver.

The support by fire element monitors movement of the assault force; it shifts fires as the assault force begins to move across the objective. To be effective, the element should be positioned on dominating terrain overmatching the enemy position. The distance between the support by fire element and the enemy position will vary. Several factors should be considered in positioning of the support by fire element:

- Available terrain. These considerations apply:
  - What terrain dominates the enemy position?
  - What dominant terrain supports the scheme of maneuver of the assault force?
- Enemy weapon system capabilities. These considerations apply:
  - Does the enemy have vehicles, ATGMs, attack helicopters, or prepared antitank positions? If so, the support by fire position should be 1,500 to 3,000 meters from the enemy to maximize the advantages of the M8.

- Is the enemy dismounted infantry? If so, the element is positioned to allow effective machine gun fires (900 meters).
- Does the enemy use mounted infantry? If so, the element is positioned beyond 1,000 meters, then repositioned closer once enemy vehicles are destroyed or enemy dismounts.
- Does the enemy have a combination of vehicles, mounted infantry, and dismounted infantry? If so, the element is positioned between 1,500 and 3,000 meters to destroy enemy vehicles, then moves closer to destroy enemy infantry.
- Support by fire weapons capabilities. These considerations apply:
  - The M8 provides the crew with protection from small arms fire.
  - The M8 can implement a ballistic solution to 5,000 meters.
  - Maximum effective range of the M240 machine gun is 900 meters.
  - Maximum effective range of the M2 machine gun is 1,800 meters.
- Time available. These considerations apply:
  - How much time is available to position the overwatch element?
  - Is any platoon currently in contact with the enemy?

**Assault Force.** The mission of the assault force is to close with and destroy the enemy. Normally composed of armored vehicles and infantry elements under the control of the company commander, the assault force moves along covered and concealed routes to the flanks or rear of the enemy. The elements move until they reach their last covered and concealed position (assault position). Once the commander has determined that all observed enemy vehicles and antitank weapons on the objective have been destroyed or suppressed, he orders the assault. The assault elements move rapidly in a line formation, under cover of direct and indirect fires, to the objective. En route, they engage enemy targets on the move (stabilized) or from a temporary halt (nonstabilized). The assault force calls for the lifting and shifting of supporting fires (direct and indirect) at the tire support coordination line (FSCL).

**Attack by Fire.** Some objectives lend themselves to an attack by fire. The purpose is to destroy the enemy from a distance. This method can be used when the enemy consists of armored vehicles and the mission does not dictate or support occupation of the objective. The support by fire element suppresses the enemy while the assault force moves to dominating terrain and, with the support by fire element, completes the destruction of the enemy (see Figures 4-21 and 4-40).

## BATTLE DRILLS

This discussion augments battle drills found in FM 17-15. These drills are a basic guide to infantry/light armor combined arms tactics. Light armor platoons, and the infantry they support, should be able to execute them upon command. Repetition in training, conducted to standard, is the key to the proper execution of drills in combat. When habitual relationships are maintained, the execution of such drills is enhanced. If habitual task organization is not possible, rehearsals are key to proper performance.

This discussion describes the drills that each light armor platoon must become familiar with and be able to execute, whether working alone or with light infantry. Each drill will show light infantry moving dismounted with the platoon, as well as mounted where applicable.

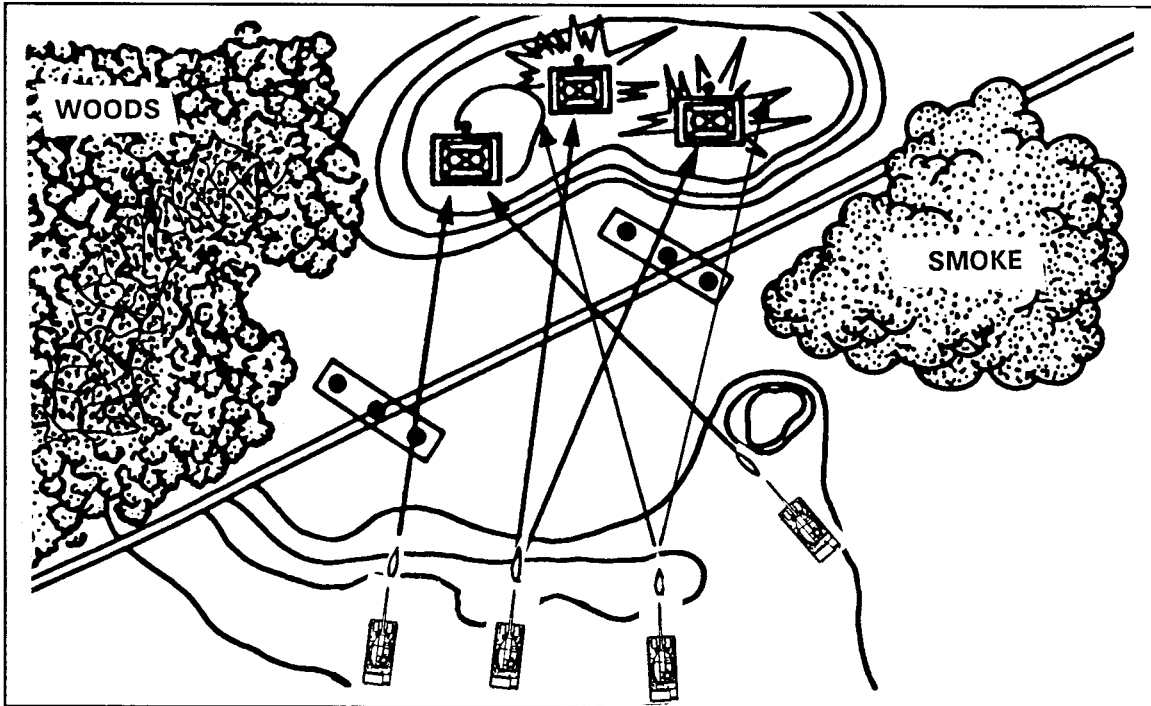

Figure 4-21. Attack by fire.

Platoons must practice drills to prepare for the C2 problems inherent in battle. Drills teach platoon members virtually automatic responses to combat situations, outlining actions to be taken immediately upon contact or in response to brief oral commands or visual signals. Crews and units gain proficiency only through practice before the battle. Drills can be carried out from any formation or movement technique.

**Actions on Contact.** When enemy fire is encountered, the platoon leader should execute the following actions on contact:

- Return fire and alert the rest of the platoon.
- Initiate a battle drill (action drill or contact drill). If no drill is specified, the platoon should seek cover and concealment.
- Send a contact report to the company commander.
- Develop the situation through fire and movement to determine the size, type, and location of enemy forces.
- Send a spot report to the commander. The platoon may destroy the target if initial fire is effective, or it may have to continue fire and movement to fix or destroy the enemy (based on instructions from the company commander).

**Change of Formation Drill.** To accomplish a rapid change of formation, each M8 commander must know the following information:

- The new formation.
- The relative position of each vehicle in the new formation.
- The position of infantrymen if they are moving dismounted within the formation.

The platoon leader can use hand-and-arm signals or the radio to inform the platoon of the new formation. He should always use hand-and-arm signals when dismounted infantrymen are in the vicinity, regardless of the method used to communicate to the other vehicles. Each TC will know his position in the formation by following an SOP that specifies M8 positions when assuming each formation. Figure 4-22 shows the movement of individual M8s during the change from column to wedge to line. The key to a successful change is practice.

**Contact Drill.** Contact drills teach the platoon how to orient weapon systems and engage an enemy without changing the direction or speed of movement along the axis of advance. This can be used when contact is made with small arms fire or when the platoon sights the enemy without being detected and does not want to stop or slow its momentum. The platoon leader can initiate a contact drill by hand-and-arm signals or radio. Even when using the radio, he should also use hand-and-arm signals when moving with dismounted infantrymen.

**Action Drill.** Action drills permit the platoon to change direction when reacting to changes in terrain or enemy contact.

**Changes in Terrain.** Using the wingman concept, this change occurs automatically when the platoon leader's vehicle changes direction. To speed up a change in direction, the platoon leader can direct an action drill using hand-and-arm signals or the radio. After executing the change of direction, the platoon automatically comes on line and continues to move. To return to the original formation, a hand-and-arm signal or radio command can be given. Figures 4-23 through 4-25 show the vehicles' relative positions during changes of direction.

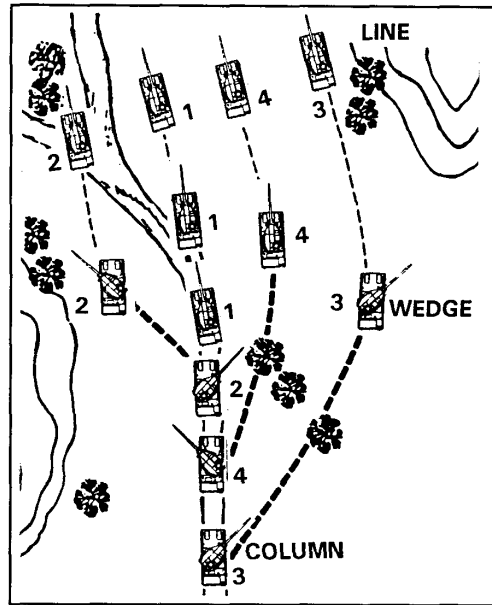

Figure 4-22. Change of formation drill.

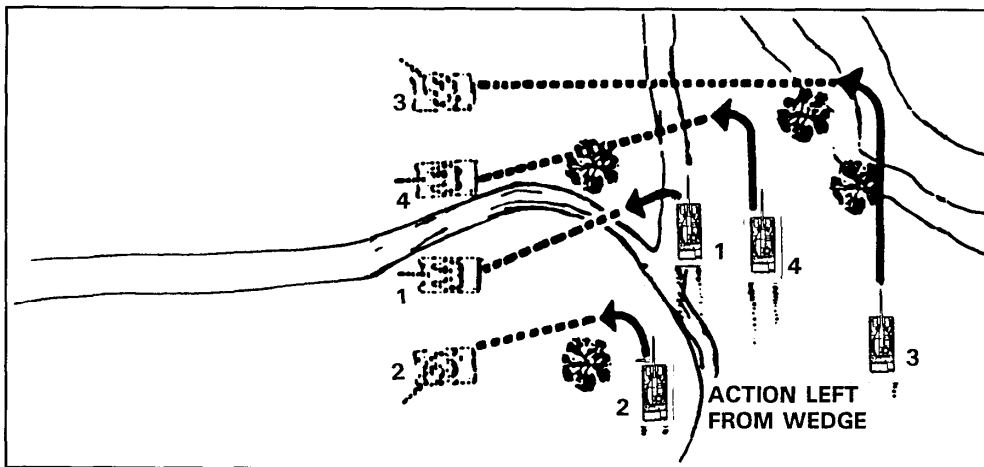

Figure 4-23. Action left drills.

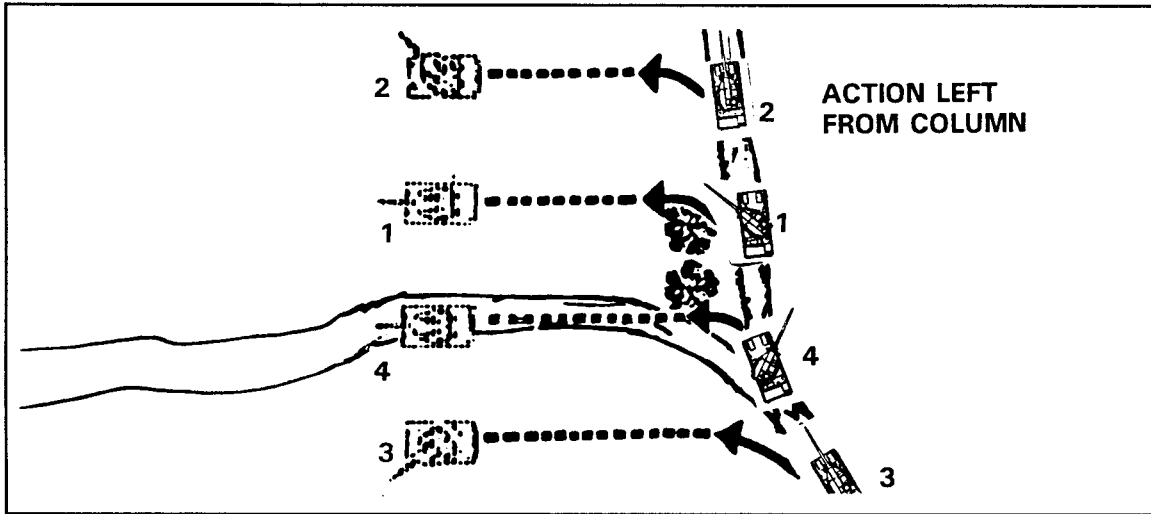

Figure 4-23. Action left drills (cont).

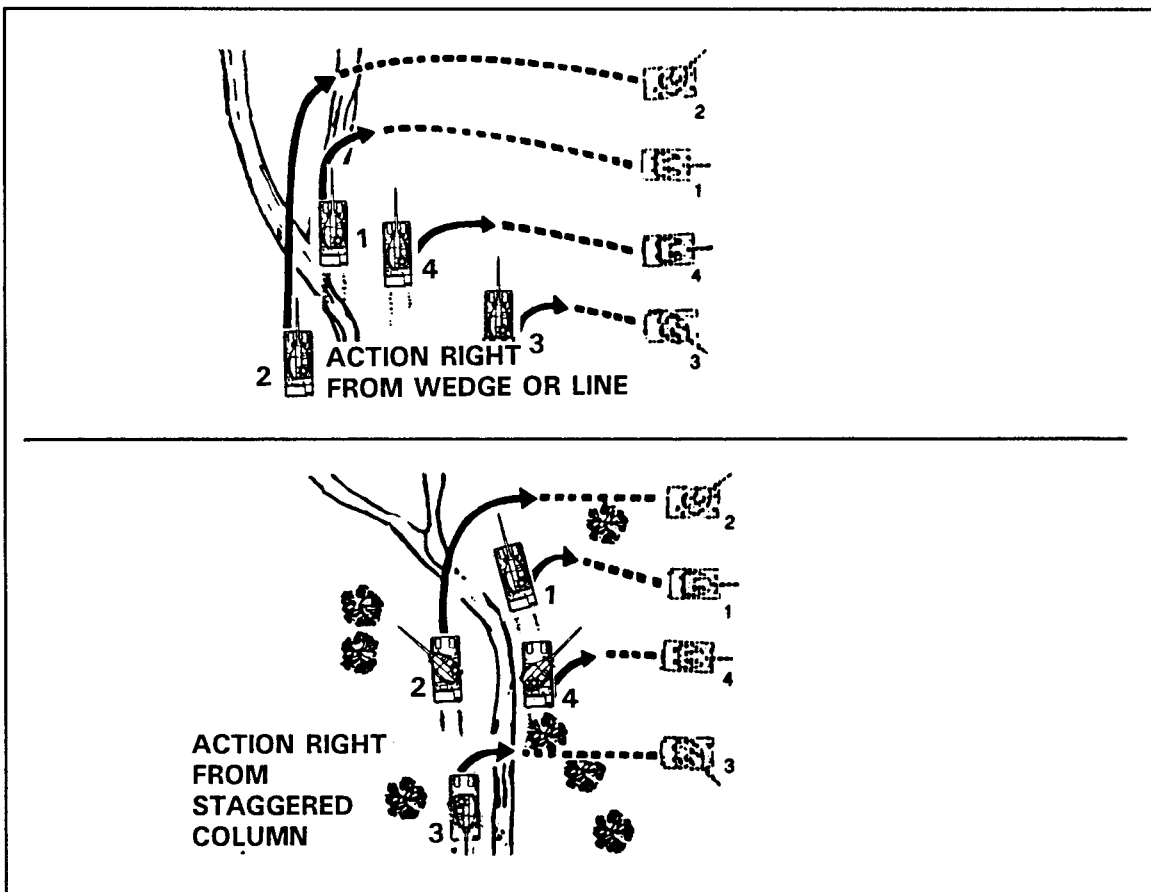

Figure 4-24. Action right drills.

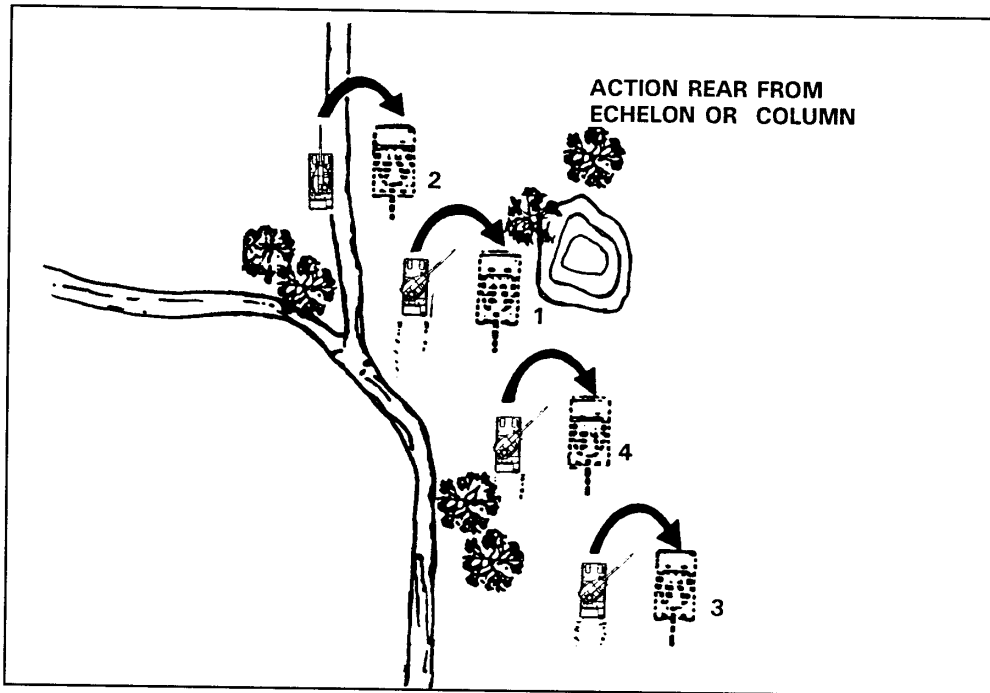

Figure 4-25. Action rear drills.

**Enemy Contact.** Following a contact report involving antitank weapon systems, the platoon leader can direct an action drill to orient the platoon's frontal armor toward the antitank fire while moving to cover and concealment.

**Figures 4-26a through 4-26e show examples of action drills when used to react to enemy contact.**



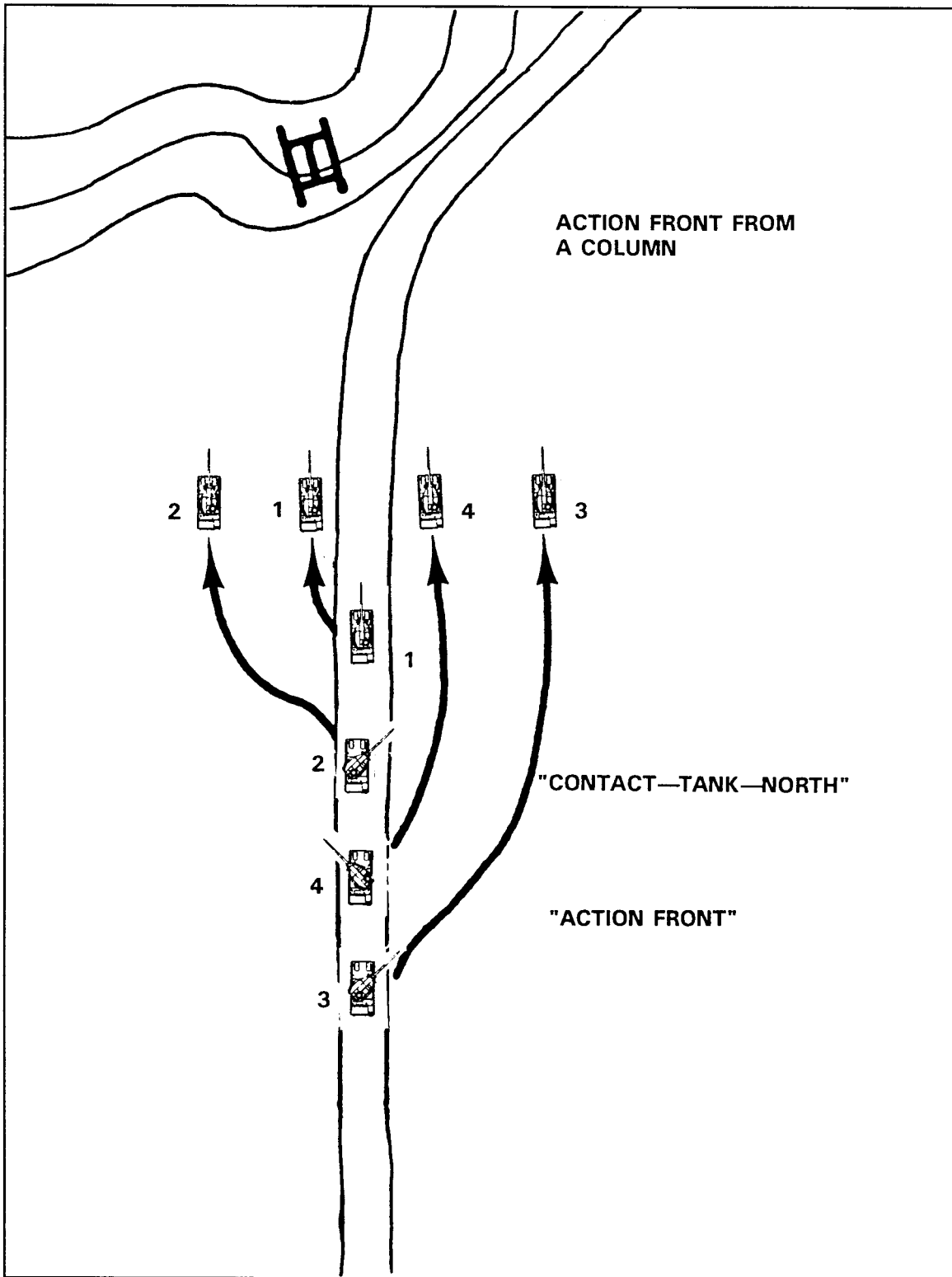

Figure 4-26a. Use of action drill to react to enemy contact (action front from a column).

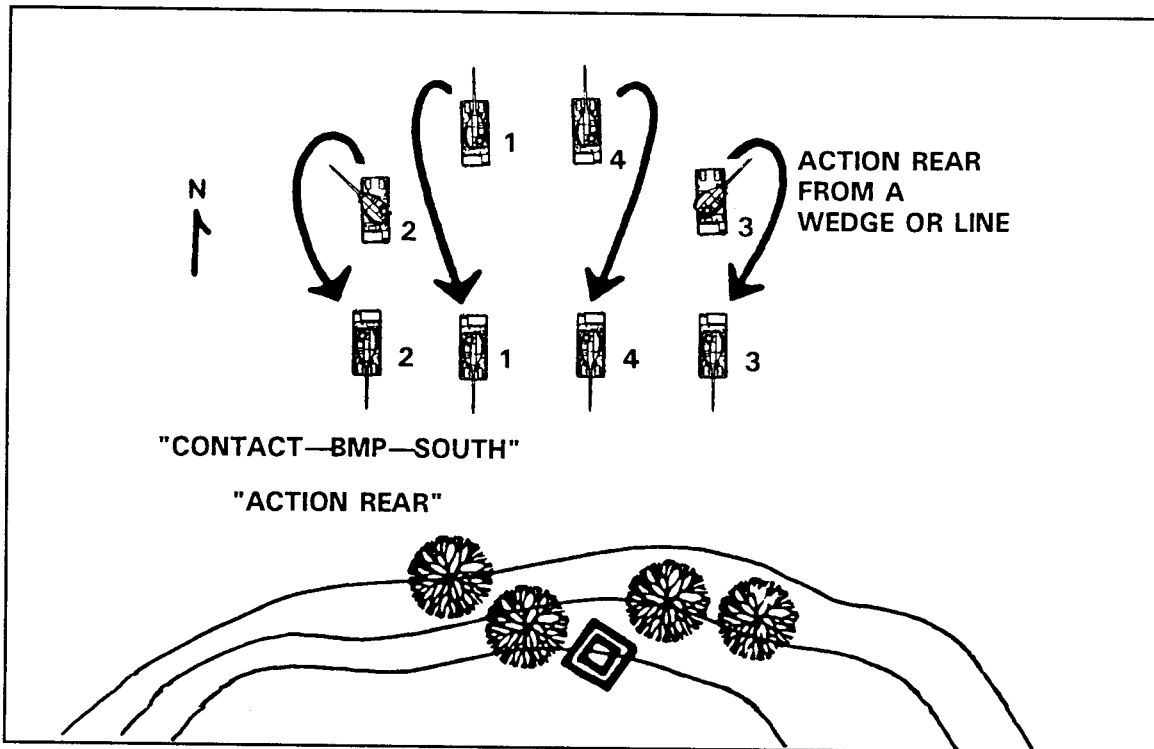

Figure 4-26b. Use of action drill to react to enemy contact (action rear from a wedge or line).

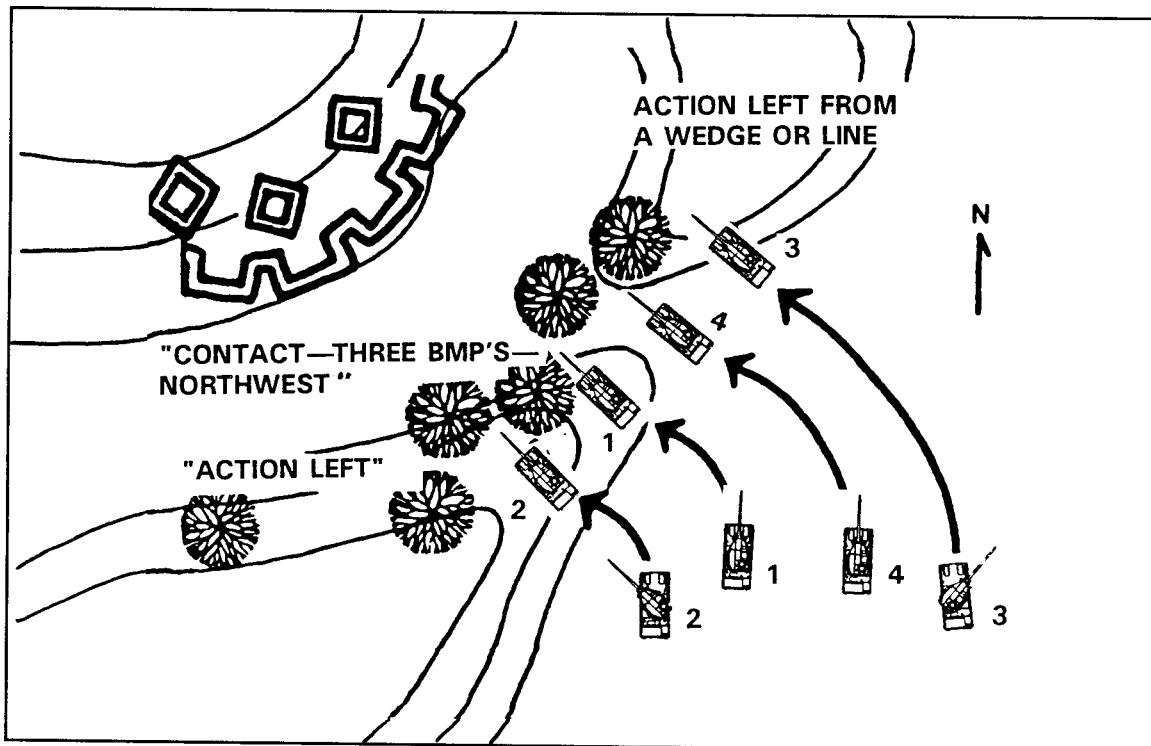

Figure 4-26c. Use of action drill to react to enemy contact (action left from a wedge or line).

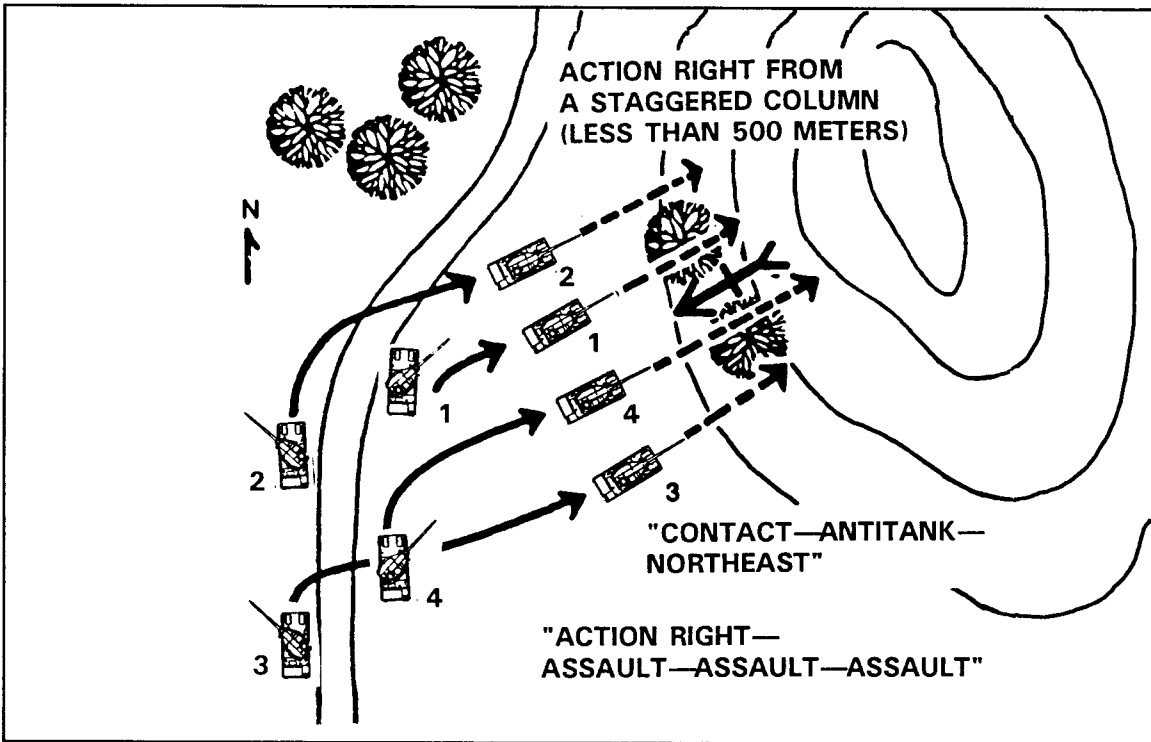

Figure 4-26d. Use of action drill to react to enemy contact (action right from a staggered column).

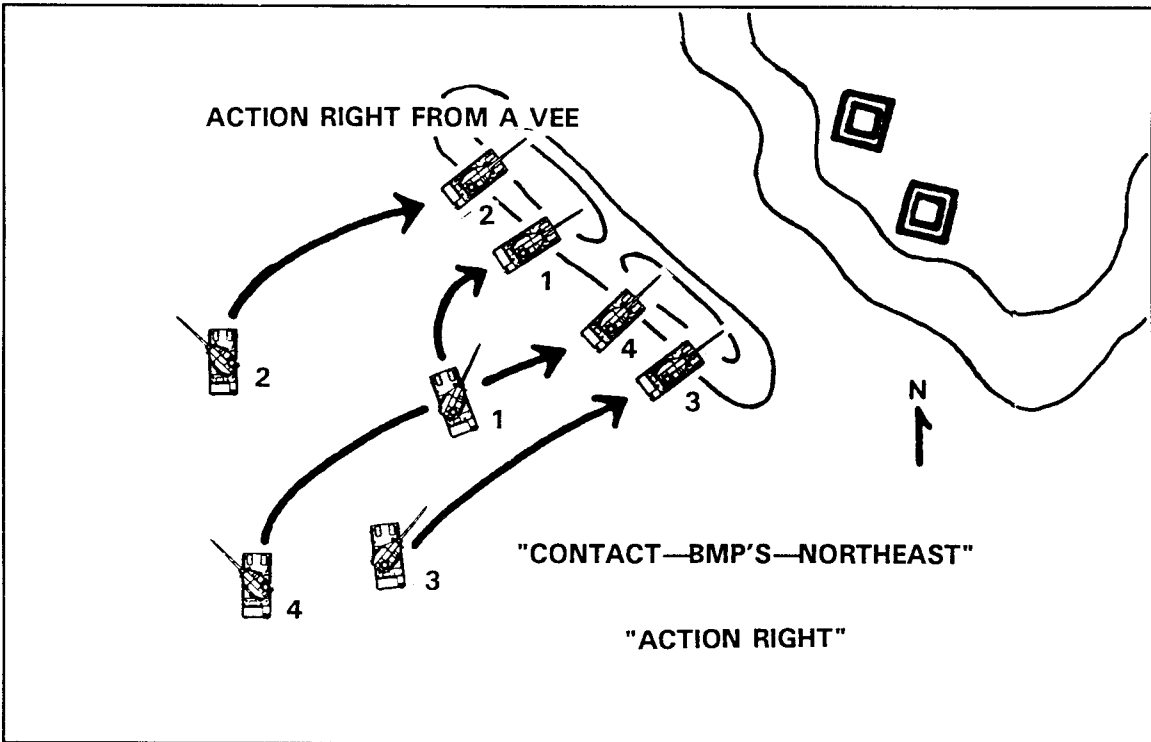

Figure 4-26e. Use of action drill to react to enemy contact (action right from a vee).

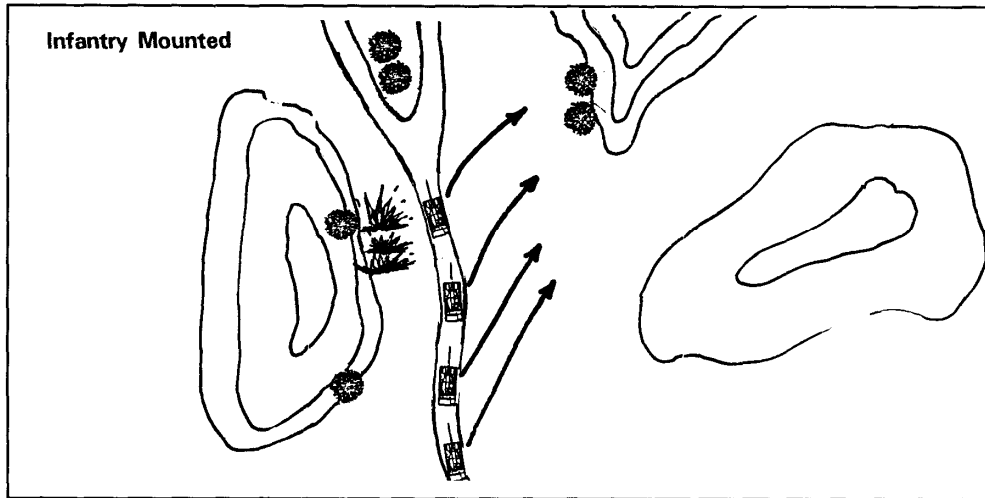

Figure 4-27. React to indirect fire drill.

**React to Indirect Fire Drill.** When the platoon receives indirect fire, crewmen close their hatches and ballistic doors. If on the move, the platoon maintains its speed and direction. With infantry mounted, the platoon leader may issue the command for an action drill to avoid casualties to the infantry. If maneuvering with light infantry, a common rally point is desirable. The platoon leader sends a spot report to the higher headquarters. If the situation permits, a more detailed shelling report (SHELREP) follows the spot report. If the mission requires the platoon to remain stationary, permission must be obtained from the higher headquarters before moving. Once clear of the indirect-fire effects, crews can open hatches and necessary ballistic doors. If masking was required by the OPORD (for example, when the enemy has NBC capability), the platoon leader has the flexibility to modify the mission-oriented protection posture (MOPP) guidance based on immediate test results. See Figure 4-27 for an example of this drill.

**React to Air Attack Drill.** The platoon should practice passive defense against air attack. Use of cover and concealment can frequently prevent high-performance aircraft and helicopters from detecting and attacking the platoon. The air attack drill involves the four steps discussed in the following paragraphs.

**Alert the Platoon.** Air guards can alert the platoon using one of two methods: announcing "CONTACT—ENEMY AIR—(direction)" over the radio or using hand-and-arm signals.

**Seek Cover and Concealment.** When moving, M8s seek immediate cover and concealment. If concealment is not available, moving vehicles should stop. A stationary vehicle is harder to see than a moving vehicle. If enemy aircraft detect the vehicles and initiate an attack, the platoon leader announces "ENEMY AIR" and exposed vehicles immediately move at a 45-degree angle toward or away from the attacking aircraft. Vehicles should maintain a 100-meter interval and avoid presenting a linear target in the direction of attack. See Figure 4-28 for a depiction of this drill.

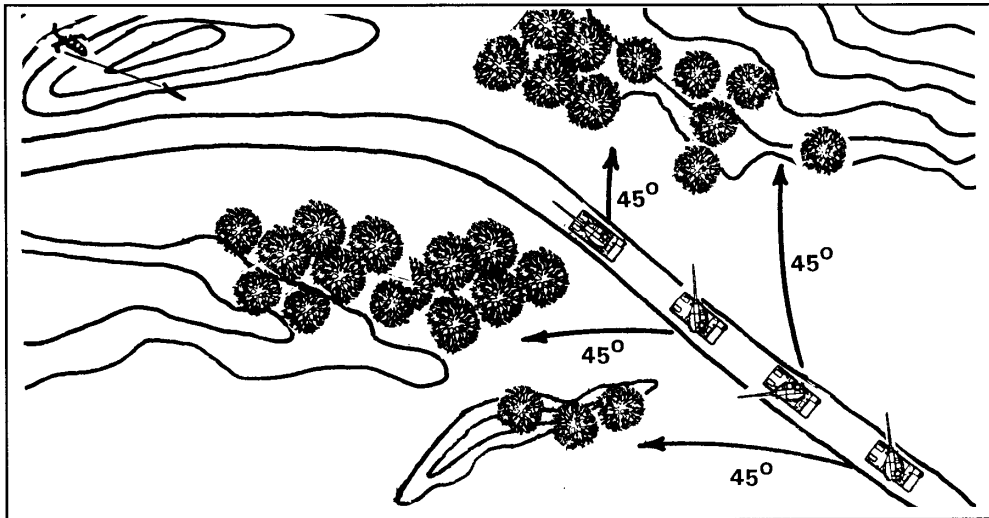

Figure 4-28. React to air attack drill.

**Prepare to Engage.** Vehicle commanders should prepare to engage aircraft with a high volume of machine gun fire on order of the platoon leader. The platoon leader must be sure that the aircraft are attacking, since firing machine guns could give away their positions. Volume is the key to effectiveness. The idea is to throw up a wall of fire and let the aircraft fly into it. In some cases, the main gun can be used against hovering helicopters. Figure 4-29 illustrates aiming points for engaging enemy aircraft.

**Report.** The platoon leader sends the higher headquarters a contact report. Example: "CONTACT—HELICOPTER—SOUTH." The platoon leader sends a complete spot report as soon as possible.

If the platoon is engaged by bombs or spray, the reaction to indirect fire drill is used.

Enemy aircraft operate in pairs, with two to eight, or more, aircraft in each flight. After the first aircraft passes overhead, another may follow. Vehicles should remain in covered and concealed positions for at least 60 seconds after the first aircraft leaves.

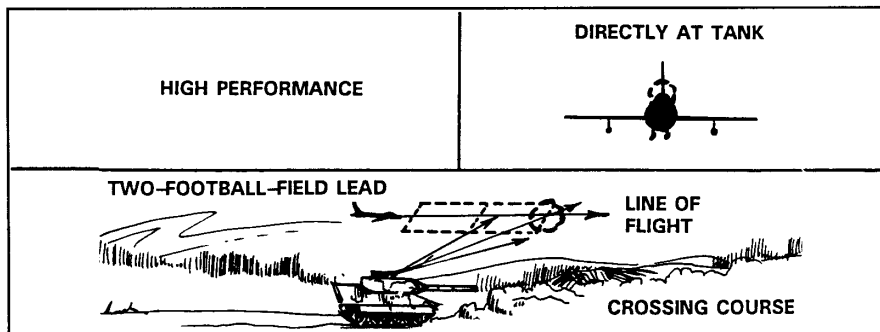

Figure 4-29. Aiming points for engaging enemy aircraft.

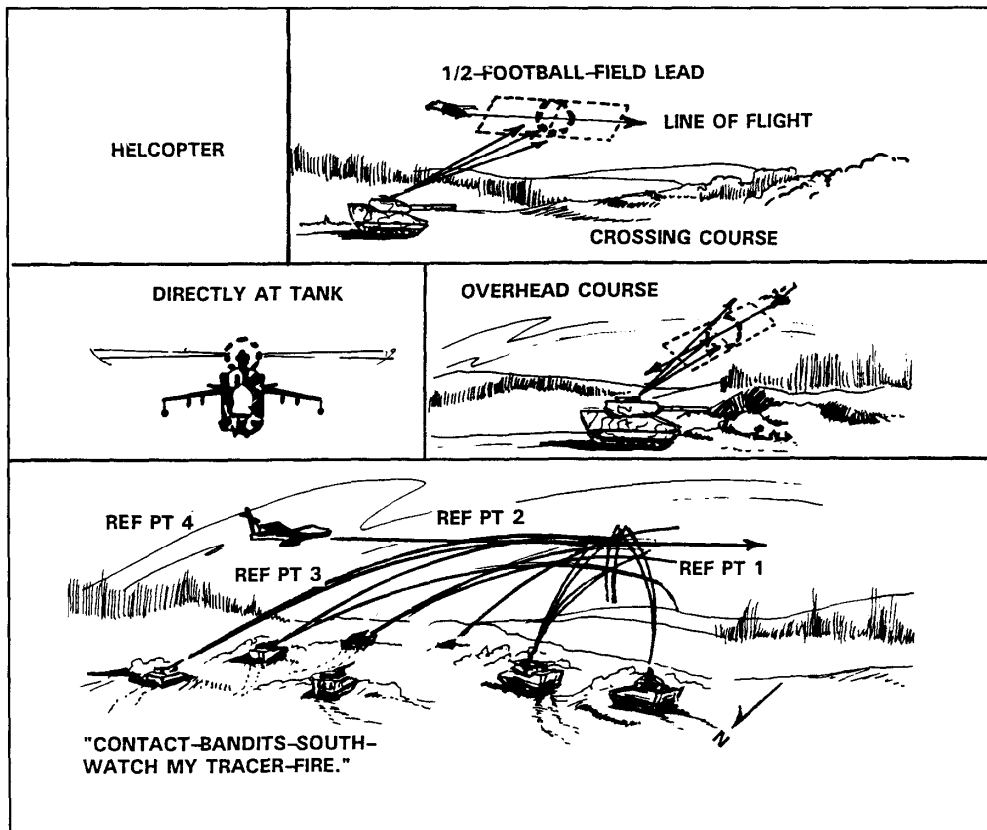

Figure 4-29. Aiming points for engaging enemy aircraft (cont).

**Break Contact Drill.** When the light armor platoon makes contact with a superior force, the commander may give the order to break contact. The voice command to break contact is "BREAK CONTACT," followed by a direction (clock method, or front, rear, left, or right). The visual signal is a red flag raised, then dropped in the direction the break is to be conducted (see Figure 4-30). The following are steps in successfully executing a break contact fire and movement drill:

- Make the initial break. The commander designates a support by fire element to provide overwatch and supporting fire, if needed. Dismounted infantry moves to a designated covered position in the direction of the break (clock method). If infantrymen are mounted on the vehicles not in contact (not the support by fire force), they may remain mounted as the vehicles move to break contact.
- M8s disengage. The support by fire element uses successive bounds to join infantry. These vehicles may employ smoke as needed. The bounds continue until contact is broken.
- Report. The platoon leader sends a spot report to the higher headquarters and prepares to continue the mission.

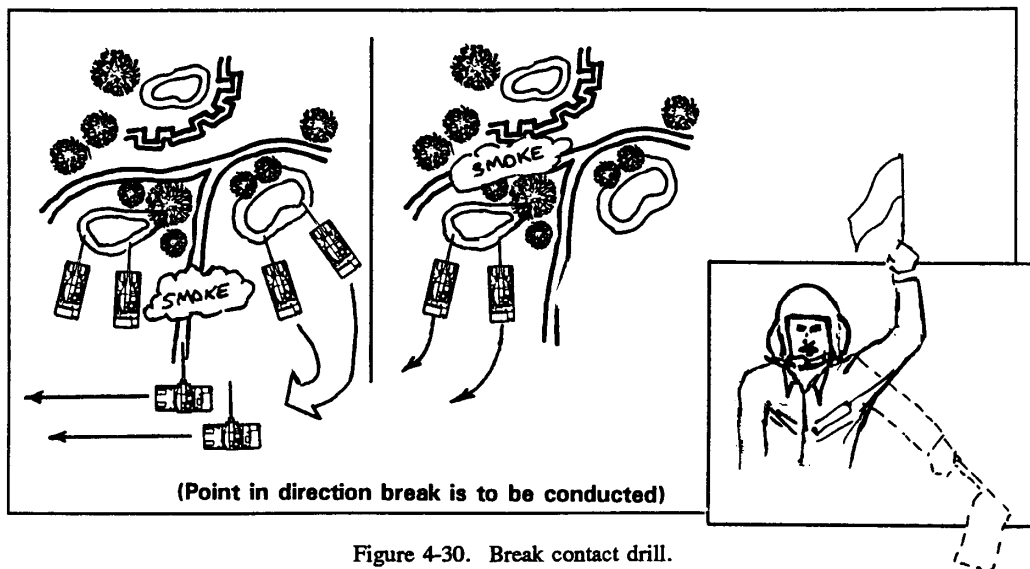

Figure 4-30. Break contact drill.

**Attack an Objective Drill.** This drill can be used during a hasty attack as a reaction to enemy contact. The voice command is “ASSAULT, ASSAULT, ASSAULT— (followed by a direction).” Steps for execution of this drill, which is illustrated in Figure 4-31, are as follows:

- The commander or platoon leader must determine and announce how the basic maneuver will be conducted. See “Methods of Attack” on pages 4-47 and 4-48):
  - Armor attacks by fire while infantry assaults.
  - Armor attacks by fire while infantry assaults, then armor joins in the assault.
  - Armor and infantry assault the objective on different axes.
  - Armor and infantry assaulting together.
- If necessary, infantrymen dismount the vehicles and move to the flanks.
- The designated element establishes a base of fire and suppresses the objective. Deception smoke is used to confuse the enemy as to the true location of the assault force. This support by fire position may later serve as the rally point for all elements if needed.
- The assault element maneuvers to the assault position (nearest covered and concealed position).
- The support by fire element shifts tires when the prearranged signal is given by the assault element as it reaches the final coordination line.
- The assault element conducts fire and movement onto the objective, secures it, begins consolidating its position, and reports to the commander or platoon leader.

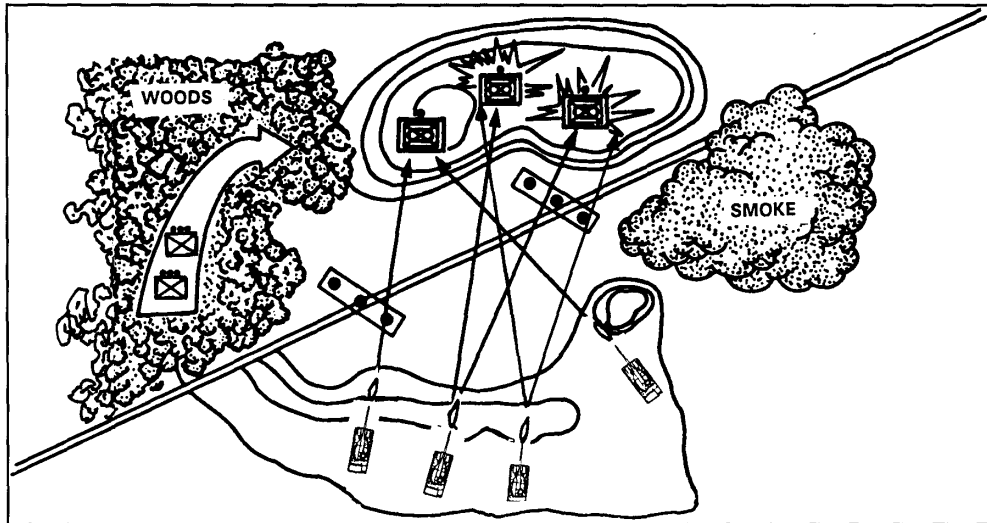

Figure 4-31. Attack an objective drill.

## ACTIONS AT DANGER AREAS

A danger area is any place the light armor platoon, or any force maneuvering with the light armor platoon, might be exposed to enemy observation, fire, or both. If a danger area cannot be avoided, light armor crosses it with great caution and as quickly as possible. The techniques used by light infantry when crossing danger areas are discussed in FM 7-8. Light armor and infantry maneuvering together use these same techniques, using armor's overwatch capabilities and infantry's ability to clear areas where hidden enemy infantry may engage friendly forces.

**Types of Danger Areas.** The following paragraphs discuss some examples of danger areas and crossing procedures.

**Open Areas.** The infantry on the near side observes and provides local security, including the near side flanks. Using an infantry guide, light armor maneuvers to the flanks to provide overwatch while the infantry moves across the open area to secure the far side (see Figure 4-32). When cleared, the remaining infantry moves across at the shortest exposed distance as quickly as possible. The light armor platoon then bounds by section across the open area and reassumes the previous designated formation. Different techniques could include the use of Dragon and TOW systems as overwatch to either supplement light armor, or to remain in overwatch as light armor bounds across the open area and clears the far side with the infantry. After clearing the far side, light armor would provide flank security.

**Linear (Roads and Trails).** Cross roads or trails at or near a bend, a narrow spot, or on low ground. Use the same techniques for linear areas as those used for open areas, except the light armor platoon may orient down the road or trail while providing near side flank security.

**Defiles.** Crossing defiles requires the infantry to clear the flanks of the defile (often high ground), the far side of the defile, and then the defile itself. If engineers are available they help locate and neutralize mines in the defile. Once the defile is cleared, light armor moves



through quickly and augments the infantry on far side security until the remaining infantry moves through or past the defile.

**Built-up Areas (Cities, Towns and Villages).** See “Offensive Operations in Built-up Areas” on pages 4-49 through 4-57.

**Trenches, Gullies, Wadis, and Tunnels.** Typically in operations other than war, the enemy will not have the resources to build fortifications and will maximize use of belowground protection. Light armor provides overwatch while infantry fights the belowground battle. Recognition signals such as smoke grenades, flaxes, and flags on antennas can indicate the location of friendly infantry to M8 crews. Light armor must be prepared to engage enemy reinforcements or any retreating enemy as they go aboveground. Light armor can also advance to engage the enemy with machine guns along the length of a trench, gully, or wadi.

**Obstacles.** See “Breach an Obstacle” on page 4-39.

**Planning Considerations for Crossing Danger Areas.** The following planning considerations apply for light armor and infantry when crossing danger areas:

- Plan rally points, the use of hand-end-arm signals (for example, signals for danger areas or bypasses), and for the use of indirect fire targets around suspected danger areas.
- Rehearse avoiding danger areas by practicing maneuvering around them.
- Rehearse actions to be taken at unavoidable danger areas; upon enemy contact (both direct and indirect fires); to control friendly direct and indirect fires; when consolidating; and upon reassuming the formation.

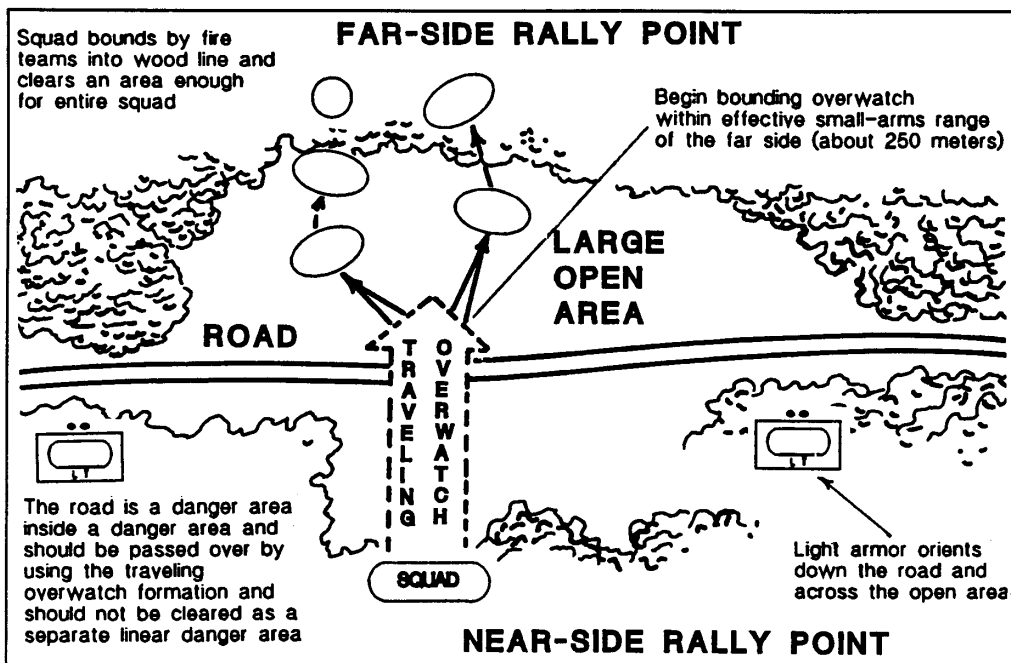

Figure 4-32. Example of actions at a danger area with light armor overwatching infantry.

**Breach an Obstacle (In-stride).** The light armor/infantry team may not be able to bypass a small or unmanned obstacle, so the commander determines to conduct an in-stride breach. The voice command for this exercise is "BREACH." The hand-and-arm signal is shown in Figure 4-33. The steps for this drill are as follows:

Organization. The commander should organize the team into three elements as described below:

- Support force. This is usually a light armor platoon or section with an infantry weapons section (M60 machine gun and/or 60-mm mortar). It leads in the movement to the obstacle.
- Breach force. This consists of infantry and engineers if available. It follows the support force to the obstacle.
- Assault force. This is usually infantry, but the commander may be able to add a light armor section. It follows the breach force when moving to the obstacle.

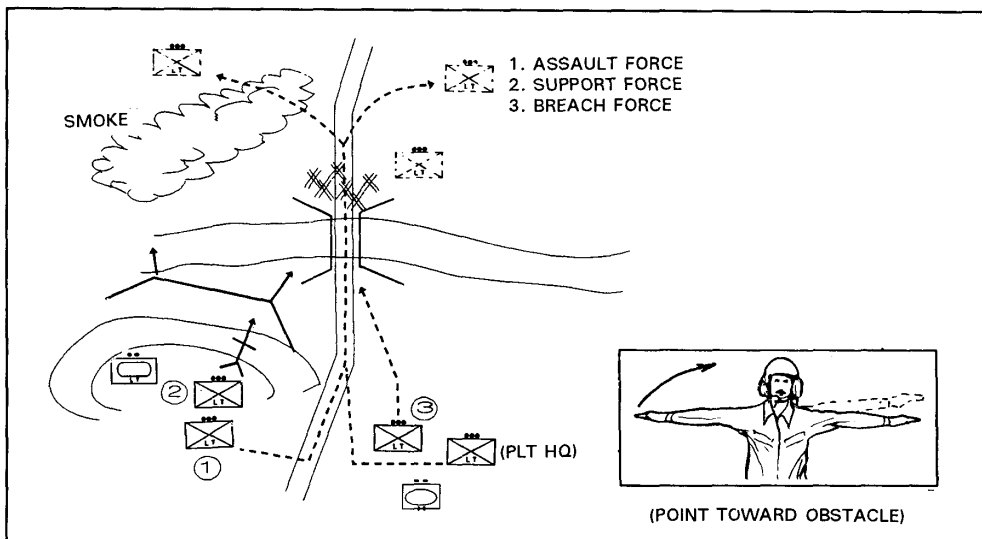

Figure 4-33. Breach an obstacle (in-stride).

**Suppression.** The support force (#2) establishes a base of fire and suppresses enemy direct-fire defenses. It must be able to suppress the enemy by direct and indirect fires, to include providing air defense coverage.

**Obscuration.** The support force adjust artillery-projected smoke on the far side of the obstacle to prevent enemy observation of the breach and assault forces.

**Security.** The breach force (#3) secures the near side of the obstacle while the assault force (#1) maneuvers to a better position to prepare for the assault. Ideally, the obstacle is breached after securing the far or enemy side. Friendly forces from the support force can reach the far side of the obstacle by infiltration, bypass, air assault, or minor breach.

**Reduction.** The breach force clears, marks, and secures the lane. The support force continues to suppress and shift indirect fires and smoke while the assault force is poised to move quickly through the breach once it is cleared and marked. The assault force moves

through the breach, conducts below ground battle, and provides far-side security by adding the shoulders against enemy counterattacks. The remainder of the breach force, followed by the support force, moves through the breach and continues the designated mission.

## OFFENSIVE MISSIONS WITH LIGHT INFANTRY BATTALIONS

The remainder of this section discusses light armor platoon offensive missions while operating with a light infantry battalion TF. The following paragraphs describe examples of how light infantry battalions attack and what role the light armor platoon will play in each mission. Light infantry battalions undertake offensive operations—

- To defeat a particular enemy force.
- To secure key or decisive terrain.
- To deprive the enemy of resources.
- To gain information.
- To deceive and divert the enemy.
- To hold the enemy in position.
- To disrupt an enemy attack.

Light infantry battalions can attack in a variety of ways and in a variety of situations. They prefer to attack under cover of darkness and bad weather, using approaches that are impossible or unlikely for other forces. The following are a few examples of likely light infantry offensive missions:

- Attack to penetrate a defensive position by infiltrating gaps and taking fortifications from the rear in preparation for the continuation of the attack by other forces (light infantry, motorized, mechanized, or armor) to greater depths.
- Attack to destroy reserves, C3, CS, or critical CSS installations in the enemy's rear by penetrating through infiltration, air assault, or stay-behind tactics. This can be as part of an attack or defense by other forces. The battalion may be a part of a brigade-size force making mutually supporting attacks.
- Attack by infiltration or air assault to seize an isolated enemy strongpoint in close terrain. This could be a guerrilla base camp or an isolated outpost guarding a defile or mountain pass.
- Attack by infiltration or air assault to seize and hold a bridge, defile, or mountain pass to assist the passage and continuation of the attack of a larger mechanized or armored force or to deny passage to an enemy counterattacking reserve force.
- Infiltration or stay-behind to ambush a mechanized column in the enemy's rear area in a defile, mountain pass, or densely wooded terrain. This mission may be part of a larger defensive operation, but it could also be part of a larger offensive operation in which the light infantry battalion provides flank protection by ambushing reinforcing enemy.
- Attack to clear and destroy small pockets of bypassed enemy or guerrillas in densely wooded, mountain, or jungle terrain. This could be in operations other than war, as a follow-and-support force in war, or as a rear area combat force to clear an area of enemy special operations forces.
- Attack to seize an enemy-held BUA. This mission requires augmentation and special training. Augmentation of engineers and firepower will be crucial.

- Attack to seize an enemy-held strongpoint by assault. This mission requires firepower augmentation and support if penetration or infiltration is not possible.
- Reconnaissance in force to determine the extent of enemy forces and positions in close terrain.
- Battalion-size raid on an enemy installation in the enemy rear.

## FORMS OF MANEUVER

The relationship between attacking light infantry and armor units is described by the five forms of maneuver. Attacks are conducted with similar forms of maneuver designed to place a light infantry battalion against a position of enemy vulnerability. Each form of maneuver has its place as an effective means of fighting the enemy. The estimate process establishes the basis of information for the commander to use in selecting the correct form. These terms describe the schemes of maneuver in paragraph 3 of the OPORD.

**Infiltration.** Infiltration permits the commander to move his force by stealth into a more favorable position to accomplish his mission. Successful infiltration requires, above all, that the force avoid detection and engagement. The commander may order an infiltration to move all or part of the battalion through gaps in the enemy's defense or to open gaps in the enemy defense for a breakthrough force (see Figure 4-34). As an alternative to infiltrating a battalion through the enemy defense, the battalion commander may order small units to infiltrate the main defensive positions along multiple infiltration lanes to—

- Destroy the enemy.
- Attack lightly held positions.
- Isolate strongpoints.
- Occupy an overwatch position from which the main effort can be supported.
- Facilitate forward movement of the exploitation force.
- Secure key terrain.
- Harass and disrupt the enemy's defensive system.
- Conduct ambushes.
- Destroy vital facilities.

Infiltrations are conducted in five phases as discussed in the following paragraphs.

**Patrol.** Find gaps, weak areas in the defense, and enemy positions.

**Prepare.** Make plans, give orders, coordinate with forward and flank units, and rehearse. Build sand tables. Give leader briefbacks to make sure the mission is understood. Tailor the soldier's load.

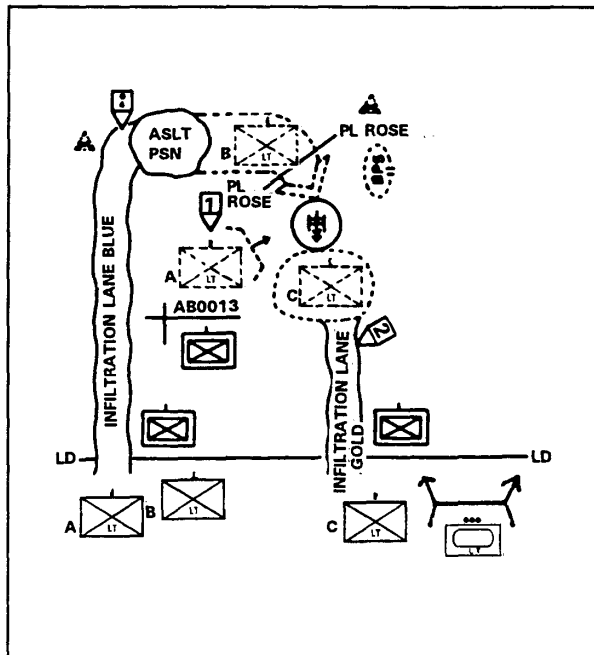

Figure 4-34. Light infantry infiltration.

## FM 17-18

Infiltrate. Avoid contact whenever possible. Ignore ineffective enemy fire.

Consolidate. Do this in the enemy rear or along a flank at a linkup point. Then move to an assembly area or objective rally point (ORP) to continue the mission.

Execute. Perform actions on the objective such as attack, raid, seize key terrain or an area, capture prisoners, or gather information. The attack is characterized by swift, violent action against the enemy to capitalize on surprise, boldness of action (doing the unexpected), and psychological effects (paralysis).

The plan for an infiltration must be simple. The commander and staff must gather detailed intelligence on the enemy, its dispositions, and the terrain to be infiltrated. Sources for information will include intelligence reports, scout situation reports (SITREP), patrol reports, weather and light data, and aerial photographs. This combat information is used to determine—

- Infiltration lanes.
- Location of rally points along the route of axis.
- Contact points, if required.
- Location of enemy security elements.
- Gaps in the enemy's defensive system.
- Strength of enemy defenses on the objective.

Control measures, such as infiltration lanes, are selected on the basis of avoiding the enemy, providing cover and concealment, and avoiding predictable routes that may lend themselves to enemy ambush sites. Single or multiple routes or axes may be used, depending on the size of the force to be infiltrated, the amount of detailed information required on enemy dispositions and terrain, the time allowed, and the number of routes or axes available. The following considerations apply:

- A single route or axis facilitates navigation, control, and reassembly. It reduces the area for which detailed intelligence is required. However, it requires more time to move the force through enemy positions.
- Multiple routes or axes reduce the possibility of compromising the entire force and make movement faster. However, they are more difficult to control.

Rally points are designated along each infiltration route. They are easily identifiable points where units can reassemble or reorganize if they become dispersed. Rally points should provide cover and concealment.

The assault position is as close as possible to the objective without compromising security. In addition to having the characteristics of a rally point, it should be large enough to allow the force to deploy. It should be reconnoitered and secured before occupation and can be used to make final adjustments prior to the attack.

Once infiltration routes or axes and rally points are selected, detailed planning continues to ensure that FS is available throughout the infiltration. Targets should be engaged first with indirect fire to avoid disclosing the exact location of the infiltrating force. Only essential equipment is taken. In very close terrain, for example, a TOW or Dragon may be a liability. Commanders should ensure the soldier's load is kept to a minimum. The largest unit possible, compatible with the requirement for stealth, moves with all elements together to increase control, speed, and responsive combat power.

**Penetration.** In a penetration, light infantry concentrates to strike at an enemy weak point and breaks through the position to rupture the defense. For the light infantry to conduct a successful penetration requires the concentration of all combat multipliers, to include use of limited visibility, stealth, and covered and concealed terrain at a selected breach point. Should METT-T analysis identify numerous weaknesses in the enemy's position, multiple penetrations may be made. In such cases, attacking forces might converge on a single, deep objective or secure independent objectives deep in the enemy's rear.

A penetration is normally attempted when enemy flanks are unassailable, when time does not permit another form of maneuver, or when the enemy is overextended and weak spots are detected in his position (see Figure 4-35). The main attack is made on a relatively narrow front and is directed toward a decisive objective.

The penetration of a well-organized position requires concentration of combat power to permit continued momentum of the attack. The attack should move rapidly to destroy the continuity of the defense; if the attack is slowed or delayed, the enemy will be afforded time to react. The attacker should avoid the enemy's EA. If the rupture is not made sharply and objectives are not secured promptly, the penetration is likely to resemble a frontal attack. This may result in high casualties and permit the enemy to fall back intact, thus avoiding destruction.

Selection of the location for the penetration is based on the following considerations:

- **Terrain.** Terrain must permit the maneuver of both the supporting attacks and the penetrating force. Lateral movement should be possible so that a successful attack can be rapidly reinforced.
- **Strength and depth of enemy position.** Ideally, the location chosen should be lightly defended to permit early penetration. The battalion should be looking for a place or places where the continuity of the enemy's defense has been interrupted, such as gaps in obstacles and minefield or areas not covered by fire or observation.
- **Distance to objective.** A short, well-concealed, direct route is desirable to prevent unnecessary exposure to enemy fires.
- **Surprise.** The place and time of attack should be selected to shatter the enemy's defense before he can react.

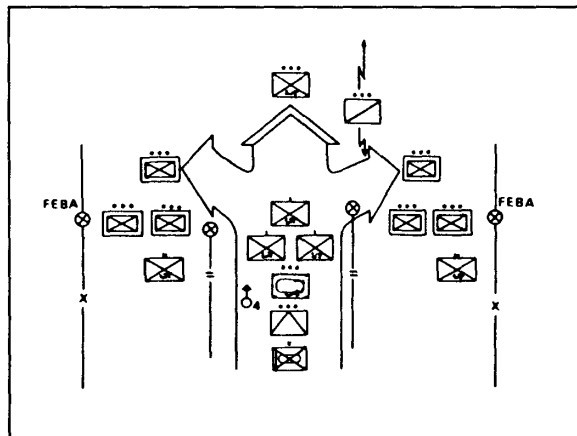

Figure 4-35. Light armor platoon participating in a light infantry penetration.

**Envelopment.** In the envelopment, the attacker passes around the enemy to strike the flank or rear of the enemy position. Envelopment is normally preferred over penetration or frontal attack; striking the enemy from several directions or from unexpected directions multiplies combat power. The enemy is forced to fight along avenues of approach that may be lightly defended or initially undefended. In an envelopment, a fixing element suppresses the enemy from the front, forcing the enemy to fight in multiple directions or to abandon his position. This disrupts his defensive continuity and makes him vulnerable to exploitation. If possible, the attacker should envelop forward positions and occupy undefended key terrain to force the enemy to abandon prepared positions.

Envelopment requires an assailable flank; that is, an open flank, weakness, or gap through enemy lines that permits the enveloping force to approach the objective. In the light infantry, a critical responsibility for scouts is to identify gaps. Routes selected for the envelopment should be covered and concealed and lead through areas where the enemy would least suspect a force to maneuver.

Envelopments require an appropriate balance of forces for the main and supporting efforts. Frequently, the forces holding the enemy in position are economy-of-force elements, with the majority of combat power being allocated to the enveloping force. Another variation of the envelopment is the double envelopment, where the attacker seeks to pass around both flanks of the enemy at the same time.

**Turning Movement.** An attacking force making a turning movement passes around the enemy, avoiding him entirely, to secure an objective deep in the enemy's rear area. This maneuver forces the enemy to abandon his position or to divert major forces to meet the threat. The selected objective may be along the enemy's line of contact (LC). The objective must be important enough to the enemy, such as a key bridge over an unfoldable river, to cause him to abandon his forward defenses.

**Frontal Attack.** Frontal attack is employed to overrun and destroy or capture a weakened enemy or to fix an enemy force in position to support another attack. It may also be used in conjunction with exploitation or pursuit of a weaker or disorganized enemy. Frontal attacks are the least desirable form of maneuver. They require intensive use of obscuration to cover friendly advances, and suppressive fires must be maximized.

## MOVEMENT TO CONTACT

A movement to contact is conducted to gain, maintain, or reestablish contact with the enemy. Once contact is made, units move quickly to develop the situation. The battalion makes contact with the smallest possible element to maintain flexibility and security. This is especially important for the light infantry because limited mobility and dependence on restrictive terrain make it quite vulnerable. Since movements to contact are usually characterized by lack of information about the enemy, commanders must plan for continuous and extensive reconnaissance and security. Movement to contact will terminate in a hasty attack or hasty defense. Two techniques are most commonly used by infantry battalions to conduct a movement to contact, an approach march and a search and attack.

**Approach March.** This is an advance of a combat unit when direct contact with the enemy is imminent. Troops are fully or partially deployed. The approach march ends when ground contact with the enemy is made or when an attack position is occupied. Using this technique, light infantry battalions normally organize into a security force, advance guard, main body, flank guards, and rear guard. The guard elements move with and secure the main body. Figures 4-36 through 4-39 show examples of light infantry battalion formations (with attached light armor platoon) in a movement to contact using the approach march technique.

**Search and Attack.** This technique is a decentralized movement to contact, requiring multiple, coordinated patrols (infantry squad- and platoon-size) to locate the enemy. It is most often used against an enemy operating in dispersed elements. When conducting a search and attack, infantry units spend more time operating in an AO rather than simply sweeping through it. Light armor platoons can have great value during search and attack operations. They primarily serve as a reserve to conduct a hasty attack to defeat the enemy by assaulting critical sites (CPs, supply points) once the infantry has found and fixed enemy forces. Figure 4-36 shows an example of a light armor platoon conducting a hasty attack on a fixed enemy force. Whether the purpose of the search and attack is destruction of the enemy, area denial, or force protection, the critical execution factor for light armor is always to be capable of rapidly massing combat power.

In conducting movement to contact, light infantry units protect the force by—

- Moving during period of limited visibility and using stealth and surprise.
- Conducting thorough reconnaissance and being able to attack at the time and place of the commander's choosing.
- Using all available combined arms assets.

Scouts are usually employed well forward of the advance guard to conduct reconnaissance for the battalion movement. Light armor elements should be given checkpoints along the movement route from which they can cover the most likely enemy armor avenues of approach. TOW sections move in bounds for mutual support and immediate responsiveness. Commanders and S3s must keep in mind that the TOWs and light armor need additional security forces. When overmatching the movement of light infantry, the light armor platoon can either move from one dominating piece of terrain to another, move with the light infantry, or move behind the light infantry. The light infantry commander must designate specific movement techniques and formations to reduce danger to the unit while moving. Once contact is made, platoons use fire and movement to develop the situation.

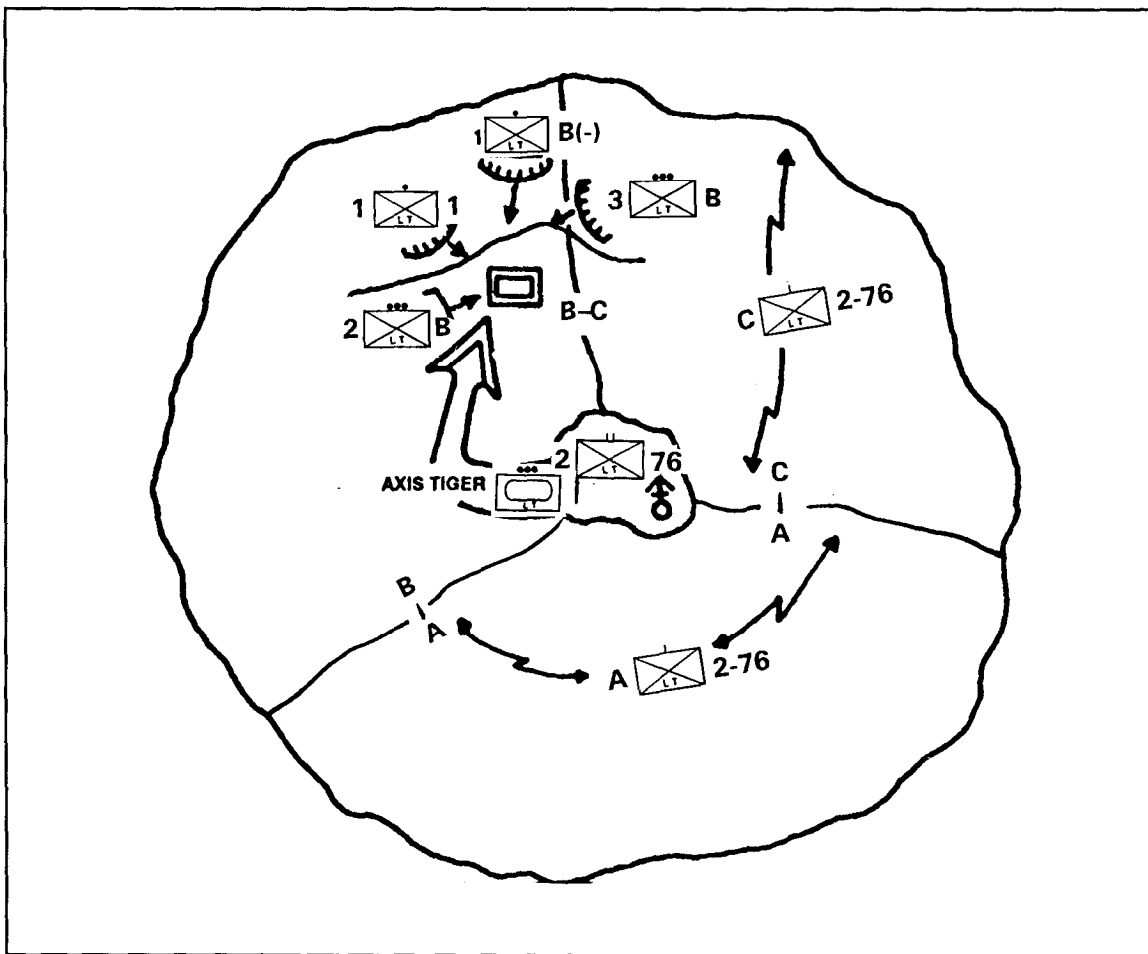

Figure 4-36. Example of a light armor platoon conducting a hasty attack on a fixed enemy force during search and attack operations.



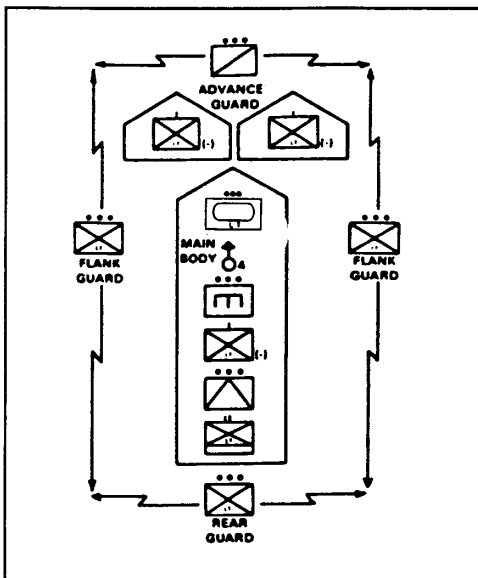

Figure 4-37. Movement to contact using the approach march technique (battalion vee).

Normally, priority of fires will be given to the advanced guard until contact is made and the main body assumes the attack; at this point, the main body receives priority of fires. The advance guard may disperse or concentrate during movement to contact. This decision is based on METT-T. Forces are concentrated when intelligence indicates the enemy is operating in company- or larger-size units or speed is a consideration. Forces are dispersed when intelligence indicates the enemy is operating in dispersed, small units or coverage is more important than speed.

When the movement to contact culminates in an attack, the battalion may attack from a wedge, vee, single-column, or multiple-column formation along the axis of advance or in a zone of action. The following considerations influence the decision of which formation to use:

- A wedge is normally used to allow the battalion to mass faster; give greater flexibility, increase the probability of contact, and increase the ease of movement. The primary disadvantage of the wedge is it is difficult to control. This formation allows the light armor to be forward for quick response.

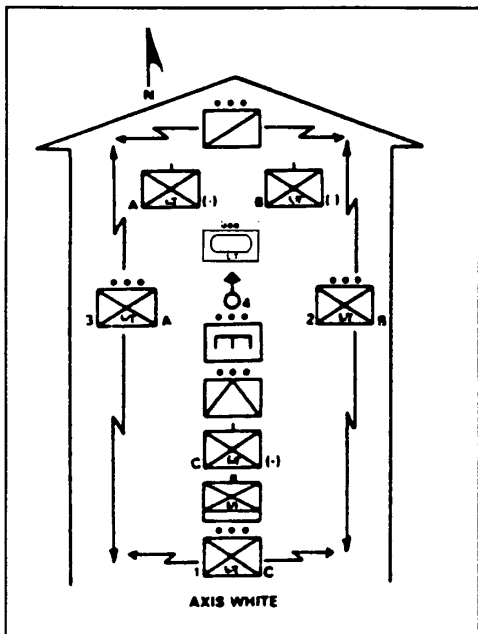

Figure 4-38. Movement to contact (wedge).

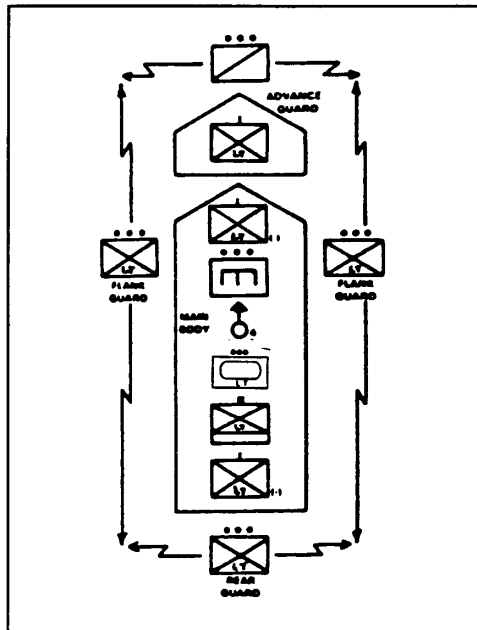

Figure 4-39. Movement to contact (battalion column).

- The vee formation is used to increase frontage, speed of reaction, and capability for envelopment. The disadvantages are that it is difficult to control and has fewer uncommitted forces and a smaller reserve. In this formation, the light armor platoon is farther back in the formation and requires greater response time.
- An attack using a single column is normally used when time is not critical. The primary disadvantages of using a single column are that it is susceptible to enemy delay tactics and takes longer to get the rear company into action.
- Multiple columns are normally used when speed is critical and wide deployment is necessary. The primary disadvantage of multiple columns is that C2 become more difficult.

## METHODS OF ATTACK

The light armor platoon and the light infantry can operate in the attack in many ways. The light infantry battalion commander, supported by the recommendations from his staff and the light armor platoon leader, will decide on which method to use based on the specific tactical situation. The following discussion examines the four most basic methods for conducting light/heavy attacks.

The light armor platoon attacks by fire while the infantry assaults the objective. The light armor platoon occupies hull-down defilade positions until the infantry masks the tank fires (see Figure 4-40). The light armor fires can be timed to divert the enemy's attention and cover the sounds of the light infantry's approach or breach. This method is most often used when enemy antitank weapons or obstacles block the only possible armor avenue of approach. Close coordination between the heavy and light forces is vital to ensure effective fire control and prevent fratricide.

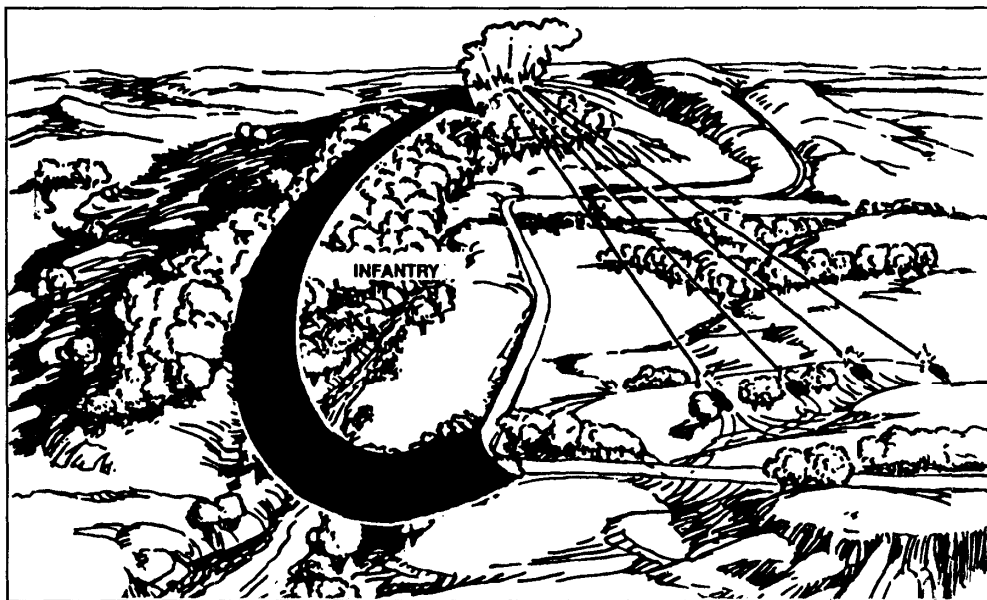

Figure 4-40. Light armor platoon attacking by fire.

The light armor platoon initially attacks by fire, then moves forward rapidly and joins the infantry for the assault. As in the first method, the light armor platoon first suppresses the objective from hull-down defilade positions while the infantry moves to an assault position. When the infantry masks the M8 fires, or upon a prearranged signal, the light armor platoon moves forward quickly and assaults slightly ahead of the infantry. This method is used when the enemy has prepared obstacles on the mounted avenues of approach. The infantry must first breach the obstacles and clear a lane for the M8s to reach the objective. Careful coordination and preparation of a detailed fire plan by the light armor platoon are essential to keep indirect fires on the objective until the final assault.

The light armor platoon and light infantry converge on the objective from different directions and assault at the same time. Open or partially open terrain that is free of mines and other tank obstacles is vital. Effective neutralization of enemy antiarmor weapons by direct and indirect supporting fires and smoke is also necessary. However, neutralization is needed only during the time required for tanks to move from their LD to the near edge of the objective. The light armor platoon must coordinate directly with the assaulting infantry for timing of the assault (the infantry will have to move earlier) and fire control on the objective. Even though this method provides surprise, increases the fire effect, and maximizes shock, actions on the objective are complex. The light armor platoon must tightly control its fires while friendly infantry clears restrictive terrain on the objective.

The light armor platoon and light infantry advance together. The light armor platoon may bound short distances, stop to fire, then bound forward again as the infantry comes abreast. This method is used when the enemy situation is vague; when the objective is very large and consists of both open and restrictive terrain; or when visibility, fields of fire, and MS movement are restricted, such as in fog, in towns, in woods, or at night. The light armor platoon provides immediate, close, direct fires, and the infantry protects the armored vehicles from individual antiarmor measures. Rather than bounding, the light armor platoon may move at the same rate of speed as the infantry. The infantry may follow closely behind the M8s for protection from small arms fire; in turn, the infantry protects the M8s from

handheld antiarmor weapons by providing security to the flanks and rear. When this method of attack is used, it is imperative that the infantry and each MS use the external phones to coordinate fires and maneuver. Figure 4-41 depicts an attack with infantry and light armor forces advancing together.



Figure 4-41. Light armor platoon and light infantry advance together.

## TYPES OF ATTACK

There are two types of attacks—the hasty attack and the deliberate attack. The main difference between them is in the depth of planning. All attack plans address intent, maneuver, and fires; all seek to strike a weak point, flank, or rear area of the enemy force.

**Hasty Attack.** Light forces must seize every opportunity to destroy enemy with violent, offensive actions. The hasty

attack is used when such an opportunity is presented and little time is available for detailed planning. It is also used to gain or maintain the initiative. A hasty attack can develop when—

- A movement to contact results in contact.
- A deliberate attack changes after it is under way.
- Further advance is ordered after securing an objective.
- A counterattack is ordered in the defense.

The commander must rapidly assess the situation, formulate a scheme of maneuver and a supporting fire plan, and communicate the scheme of maneuver to his subordinates using FRAGOs. The unit then conducts the hasty attack using infantry and armor fire and movement.

The primary employment of the hasty attack is in conjunction with a movement to contact, during which the unit may be assigned the mission of securing a terrain feature or of destroying an enemy force. When enemy contact is made en route to securing an objective, the light armor platoon may conduct the hasty attack with the infantry TF by—

- Fixing and bypassing the enemy, depending on enemy strength and the unit's orders.
- Attacking by fire to destroy the enemy and then bypassing.
- Conducting a hasty attack to kill the enemy and continuing the attack to the objective.

Depending on his orders and the size and location of the enemy, the commander develops a plan to conduct a hasty attack when enemy contact is made. He designates an objective, a support by fire element, the support by fire element's overwatch positions, an assault element, and covered and concealed routes into the flanks of the enemy. He then issues a FRAGO to his platoon leaders.

The first unit to make contact with the enemy executes actions on contact and assumes the role of the support by fire element. As discussed in the methods of attack, the commander employs the light armor as the assault force or to engage the enemy upon contact while he develops and issues his plan to assault the objective with infantry.

**Deliberate Attack.** If the light armor platoon can execute a hasty attack, it can execute a deliberate attack. A deliberate attack is distinguished from a hasty attack by a more detailed knowledge of the enemy; a larger amount of time devoted to planning, coordination, and preparation; and more extensive collection and use of intelligence. Once begun, the deliberate attack is executed with the same speed, violence, and application of concentrated combat power as a hasty attack. Units normally conduct a deliberate attack from defensive positions.

## OFFENSIVE OPERATIONS IN BUILT-UP AREAS

Because of the nature of the terrain, offensive operations in BUAs are normally conducted by dismounted infantry. Combat is characterized by house-to-house fighting; restricted observation, fields of fire, and maneuver space for armored vehicles; and difficulty in C2. M8s are employed as much as possible in close support of dismounted teams to secure locations and provide direct FS.

**Types of Built-up Areas.** Characteristics of BUAs differ by country and region. The following are general categories that help separate BUAs by type:

- Villages, with populations of 3,000 or less.
- Strip areas, which are BUAs along roads connecting towns or cities.

## FM 17-18

- Towns or small cities, with populations of up to 100,000 and not part of a major urban complex.
- Large cities and associated urban sprawl, with populations of up to 20 million and covering hundreds of square kilometers.

**Basic Building and Street Patterns.** Each BUA or urban area has its own characteristics, making each objective a unique challenge for the infantry/armor team. The following list includes the typical building/street patterns that light forces will encounter in urban terrain:

- Dense, random construction.
- Closed, orderly blocks.
- High-rise areas.
- Industrial/transportation facilities.
- Dispersed residential areas.

On the outskirts of suburbs, small plots of land, gardens, farms, fields, or vacant lots surround isolated houses or groups of houses. The attacking force usually will start at this part of the BUA. It should treat houses as inferior bunkers or individual emplacements.

In the residential district, streets, gardens, and grassy plots usually flank closely spaced, detached, or semidetached buildings. The arrangement may or may not follow a geometric pattern. The center of the BUA is usually the business section. It will almost always consist of buildings of block-type construction, with little or no space between them, except for an occasional park, street or alley. This will require fighting from building to building and block to block.

**Attacking in Built-up Areas.** A detailed study of the city and the enemy's dispositions in and around it forms the basis for planning the attack and seizure of a BUA. Planning may include M8s for both maneuver and FS. The attacking force is normally separated into two forces—the enveloping force (armor heavy) and the direct assault force (infantry heavy). Follow the procedures and considerations listed below when attacking a BUA:

- Dissipate the enemy's strength by causing him to react to demonstrations, feints, or ruses.
- Concentrate overwhelming combat power to force a quick and violent disruption of the defenses, envelop the BUA, and move rapidly to the enemy's rear.
- When possible, reduce strongpoints with fires only, secure them with follow-on forces, and keep moving.
- Cut lines of communication and defeat the enemy through isolation.
- Attack at night to gain surprise or to take objectives whose assault during daylight would be too costly. An attack at night will take advantage of the M8's thermal sight capability.
- Once momentum has been gained, attack continuously until defenses have been splintered.

**Attack Phases.** An attack of a BUA comprises three phases:

- Isolation of the BUA.
- Gaining a foothold at the edge of the BUA.
- Systematic clearance and seizure of objectives.

Isolation. The first phase is the isolation of the city and the seizure of terrain features that dominate approaches to it. The attacker has the advantage of maneuver to isolate the city he will seize. The enveloping force—

- Prevents the escape of the enemy.
- Prevents reinforcements from entering the BUA.
- Provides direct fire support for the direct assault force.
- Protects the direct assault force from counterattack.

Once he has isolated the city, the attacker can either press the attack or contain the defender and force him to capitulate. If necessary, the unit then secures positions outside the BUA from which to support entrance into the city itself. The tactics and techniques for this phase of the operation are similar to those used in an attack against an enemy strongpoint (see Figure 4-42).

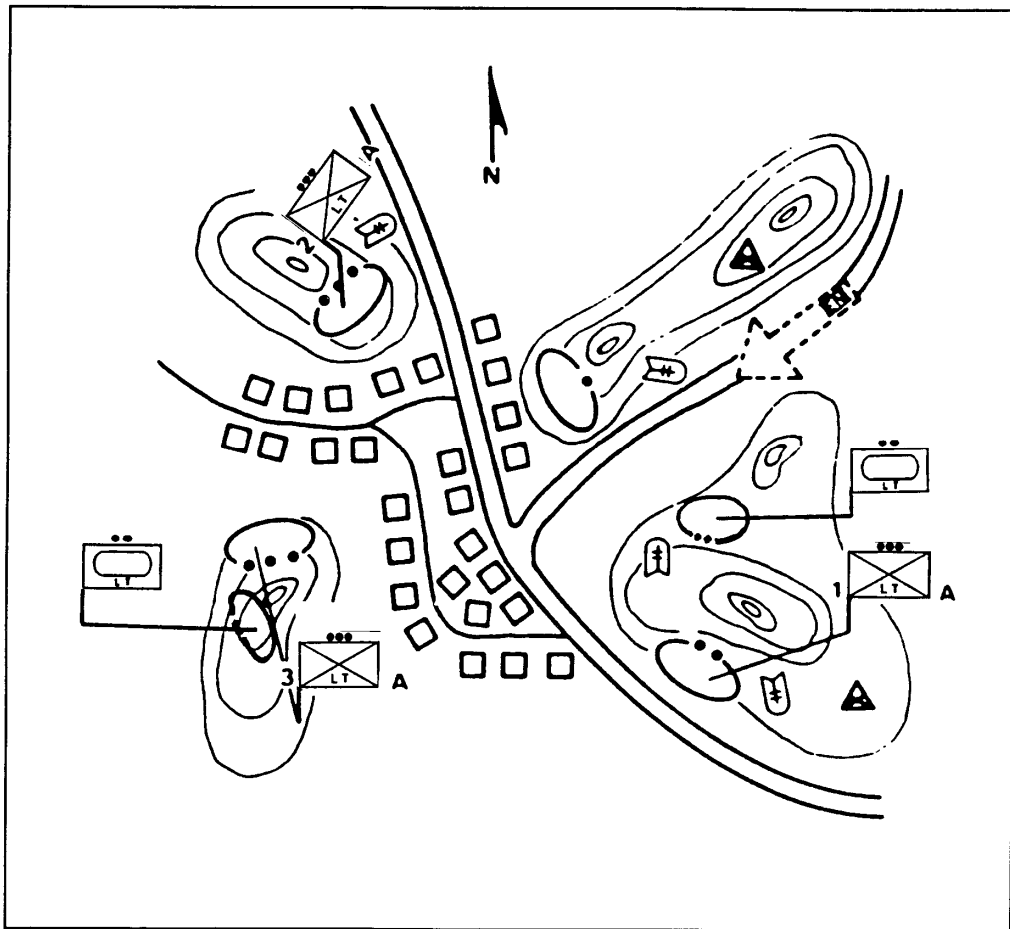
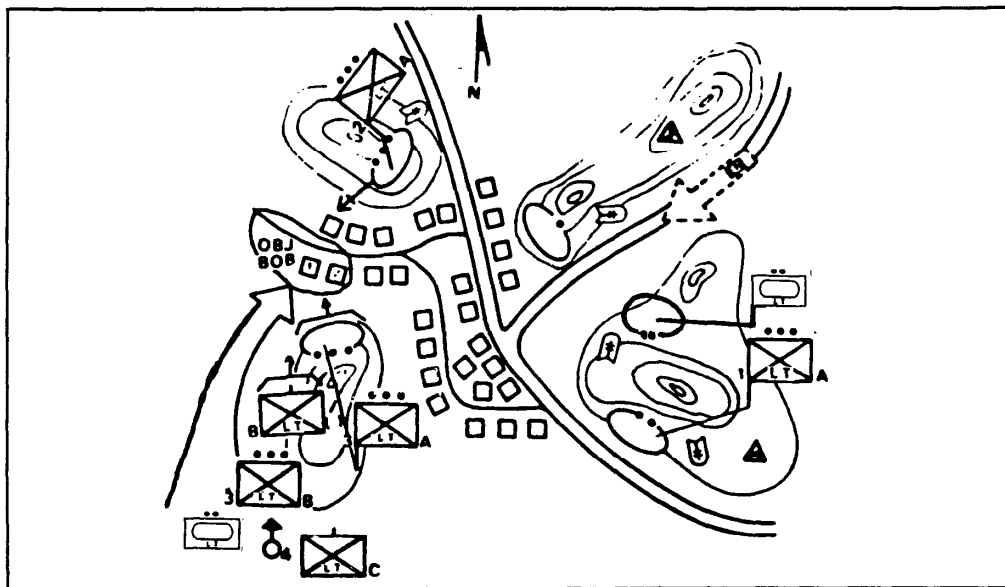

Figure 4-42. Isolating the built-up area.

**Gaining a Foothold.** In the second phase, the attacker selects his best point of entry into the city. He can attack from any direction; he can bypass strongly defended buildings by going under, over, and around them and by using cellars, sewers, subways, or other underground passages. The unit advances to the edge of the BUA to gain a foothold and eliminate the defender's observation of (and direct fires on) approaches into the area. The assault force uses the foothold area to reorganize, decentralize control, and displace units to supporting positions. The attacking unit penetrates the area on a narrow front; M8s with infantry lead the way. The commander concentrates all available supporting fires on the entry point (see Figure 4-43).

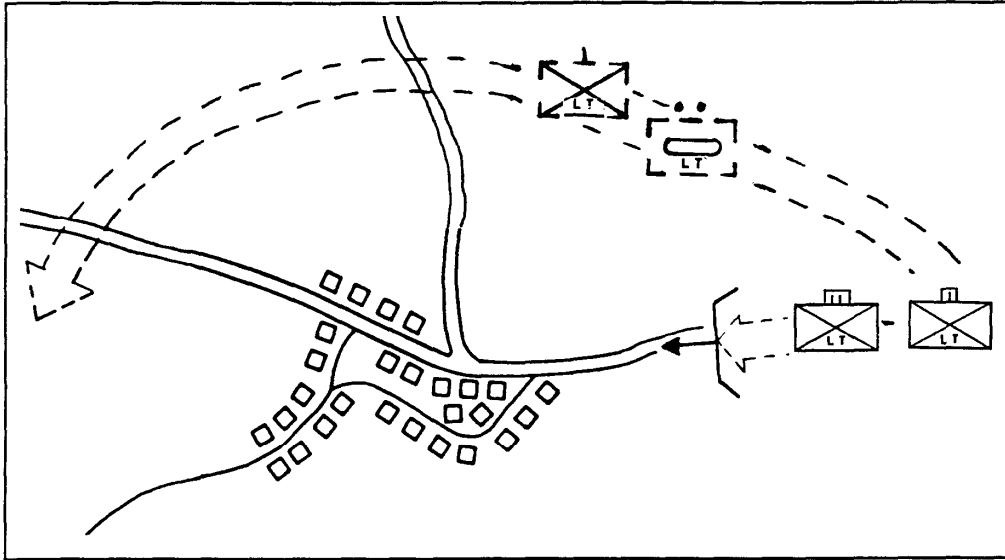

**Figure 4-43. Concentrate fire to gain a foothold.**

The probability of success increases when the commander launches his assault from an unexpected direction in the early morning just before light or under the cover of smoke. The commander normally employs a column formation in the initial assault. Assaulting forces can expect to encounter barricades, antitank mine obstacles, and antitank fire.

The commander may employ variations of the column formation. For example, a battalion TF may use a column, with each of its company teams in a line, wedge, or echelon. These formations tend to shorten the length of the column, reducing the time necessary to move into the BUA. The leading elements of the force should use a formation that speeds the delivery of maximum fire on the point of penetration. The commander should place artillery air bursts over the entry point to prevent the enemy from manning crew-served or individual antitank weapons. The infantry moves as close to the objective as possible. When the infantry attacks a strongly defended area, it provides close-in protection for the M8s. Unit leaders may assign fire teams or squads to work with each M8. Visual signals help maintain direct communication between the rifle squad or fire team leader and the M8 commander. The infantry maneuvers to engage or destroy the resistance. M8s move forward as soon as possible to support them. When possible, the M8 fires augment the assault or cover critical areas on the force's flanks. When buildings on the periphery of a town are heavily fortified, the commander may have to employ techniques for the attack of a fortified area.

**Clearance and Seizure.** Phase three can vary from a systematic block-by-block, house-to-house reduction of the BUA to a rapid advance with clearance of critical areas and buildings. It begins without pause after the completion of phase two. Clearance and seizure techniques depend on the mission, the size of the town, construction and building arrangement, and the enemy's disposition, strength, and objective. The direct assault force clears the city of enemy resistance and links up with the enveloping force when the unit must continue to move (see Figure 4-44).



**Figure 4-44. Enveloping and assault forces.**

When the BUA is large and heavily fortified or when the mission requires it, units may have to perform a methodical house-by-house, block-by-block clearance operation. The commander should divide the area into zones of responsibility. Each subordinate unit must clear its zone completely, leaving no enemy to its rear.

When the BUA is small or lightly defended, the attacking force should drive through or into it as rapidly as possible. Light armor should lead the column in this instance, closely followed and supported by infantry. It will rarely be possible to employ more than two M8s at the head of the column except when advancing on a wide street. M8s continuously concentrate main gun and automatic weapons fire on windows and the rooftops of buildings (see Figure 4-45). The infantry protects the M8s from close-in enemy fire. When required to protect tanks from fire from nearby buildings, an infantry squad moves along each side of the street, keeping abreast of the lead vehicles. Depending on the resistance, the squad may challenge every doorway or ground floor window by throwing in hand grenades and spraying the interior with small arms fire. Unit leaders will usually assign soldiers in each squad to locate and engage targets on the upper floors and rooftops of the buildings. The infantry may also assist in the removal of obstacles or barriers halting the advance.

When seizing buildings, the M8s support the assault by isolating the building and providing suppression during entry (see Figure 4-46). The M8 can also create a hole in a wall of a building with main gun fire to allow the infantry to enter the building through an unexpected entrance.



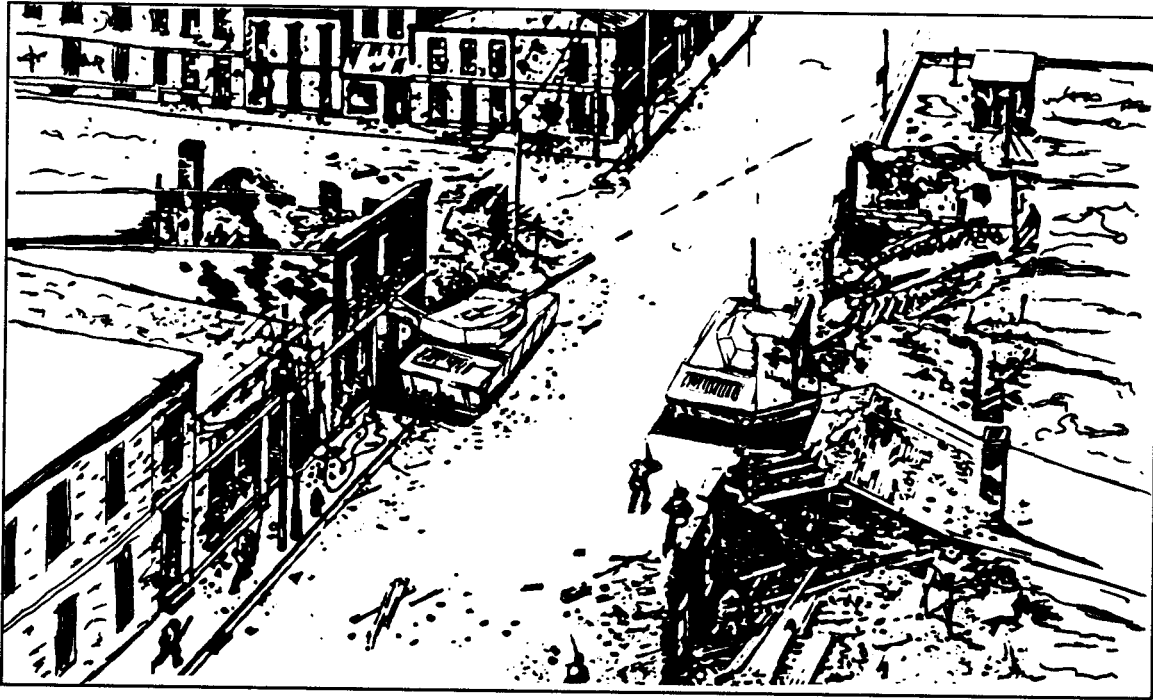

Figure 4-45. M8s advancing with infantry.

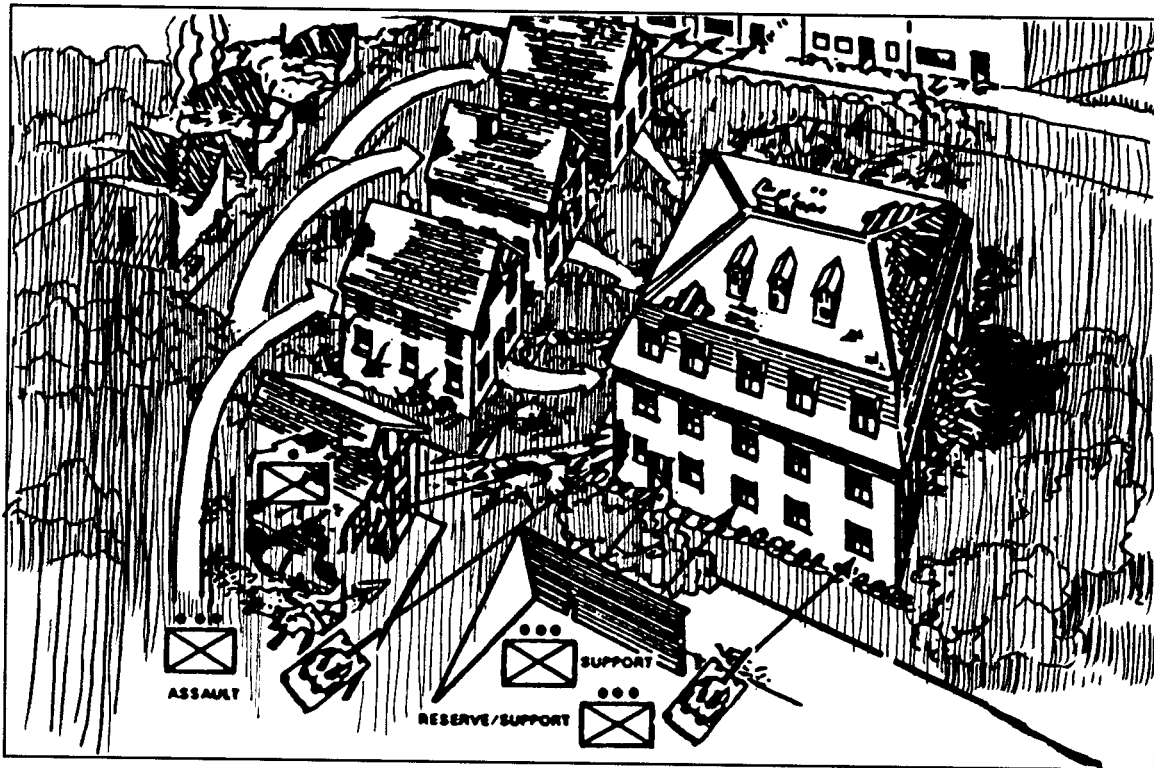

Figure 4-46. Isolating and seizing a building.

The following procedures apply when attacking a BUA:

- Dissipate the enemy's strength by causing him to react to demonstrations, feints, and ruses.
- Concentrate overwhelming combat power to force a quick and violent disruption of enemy defenses, envelop the BUA, and move rapidly to the enemy's rear.
- When possible, reduce strongpoints with fires only, secure them with follow-on forces, and keep moving.
- Cut lines of communication and defeat the enemy by isolating him.
- Attack at night to gain surprise or to take objectives that would be too costly to assault during daylight. A night attack will take full advantage of the M8's thermal sight capability.
- Once momentum is gained, keep the attack continuous until enemy defenses have been splintered.

**Light Armor Tasks.** When the light armor platoon is included as part of the direct assault force, it should be employed as a platoon. In BUAs that are very restricted, however, sections may have to operate separately, each under the control of an infantry commander. Light armor supports infantry in BUAs by—

- Providing shock action and firepower.
- Isolating objectives with direct fire to prevent enemy withdrawal, reinforcement, or counterattack.
- Neutralizing or suppressing enemy positions with smoke, high-explosive (HE), and automatic weapons fire as infantry closes with and destroys the enemy.
- Assisting opposed entry of infantry into buildings when doorways are blocked by debris, obstacles, or enemy fire.
- Smashing through street barricades or reducing barricades by fires.
- Using fires to reduce enemy strongpoints in buildings.
- Obscuring enemy observation using on-board smoke generators.
- Holding cleared portions of the objective by covering avenues of approach.
- Attacking by fire any other targets designated by the infantry.
- Establishing roadblocks.
- Suppressing identified sniper positions.

**Light Infantry Tasks.** Light infantry supports light armor in urban terrain by—

- Locating targets for engagement by light armor weapons.
- Suppressing and destroying antitank weapons with mortars, automatic weapons, and grenades.

## FM 17-18

- Assaulting positions and clearing buildings.
- Providing local security for M8s at night or during other periods of reduced visibility.

**M8 Employment Considerations.** The following are some techniques and concerns the light infantry and/or armor leader should consider when employing M8s in urban terrain:

- M8 main gun fire is an effective method for eliminating a sniper in a building or creating a psychological effect that destroys his will to continue.
- Streets and alleys constitute ready-made fire lanes and firing zones. They can greatly restrict and canalize vehicular traffic, making it vulnerable.
- In urban terrain, light armor works best in platoons or in sections of two M8s. In extreme cases, M8s can work individually, but this is not recommended.
- At least one infantry squad should remain with each armor vehicle to furnish local security.
- The external phone is an excellent means for communication between the infantryman and the vehicle commander.
- The M8 should use HE ammunition to create holes in the walls of buildings so the infantry can enter.
- The M8 should use HE ammunition against barricades. HE will demolish steeples, chimneys, and other tall structures likely to contain enemy artillery observers. This technique is dependent on the established rules of engagement. In operations other than war, minimizing collateral damage may be a priority. However, crews can fire on observed or known hostile enemy positions at all times.
- Crew members must be on the alert for bunkers or pillboxes in houses along the street.
- M8s should avoid stopping or moving slowly near nonsecure buildings.
- Units should check all bridges and overpasses for mines and should determine their weight-carrying capacity.
- M8s should stay near buildings held by friendly troops. Crew members should watch for signals from the infantry inside the buildings on their flanks.
- M8 crew members should keep their personal weapons ready for close-in combat.
- When possible, M8s should destroy enemy strongpoints with main gun fire. One technique is to fire armor-piercing ammunition to penetrate the reinforced wall of a building followed by high-explosive antitank (HEAT) rounds to kill or neutralize the enemy. M8s should fire first into the ground floor to drive the enemy into the basement, where infantry can attack them, or to higher floors, where light armor fire can destroy them.
- M8s are at a disadvantage because their main guns cannot depress or elevate sufficiently to fire into basements and upper floors at close range (see Figure 4-47).

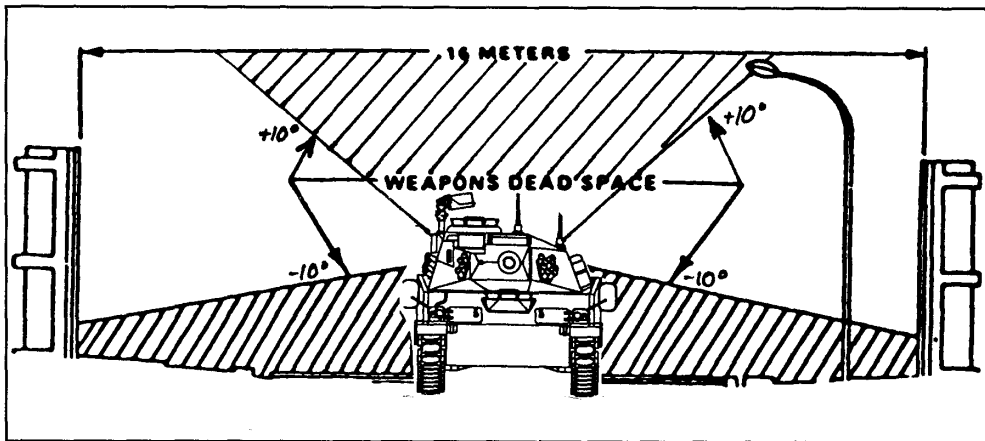

Figure 4-47. M8 dead space on narrow streets.

**Control Measures.** Combat in BUAs requires control measures with which all troops must be familiar. These include the following:

- **Boundaries.** In dense urban areas, units should place boundaries along one side of the street to provide easy and definite identification. In areas where observation and movement are less restricted, they may place boundaries in alleys or within blocks so that one unit's zone includes both sides of the street.
- **Objectives.** Objectives are specific and limited. Choosing major intersections, principal buildings, or other readily identifiable physical features improves control. Numbering buildings along the route of attack simplifies the assignment. As the unit moves forward through an area, unit leaders should designate the near side of the street as the objective. If they choose the far side of the street, the unit will have to secure buildings on both sides of the street to take the objective. Units must promptly report seizure of objectives.
- **Frontages, formations, and zones of action.** Attacking battalions normally operate within relatively narrow zones of action. The frontages depend on the enemy's strength, the size of the buildings, and the anticipated resistance. Normally, a light infantry battalion TF has a frontage of three to six blocks and attacking companies of one to two blocks. Frontages and zones of action influence M8 employment. The M8s should be well forward to add momentum to the attack, exploit success, repel counterattacks, and protect the flanks and rear against enemy action.
- **Phase lines (PLs).** PLs increase control by regulating the advance of attacking forces. They also indicate where the command passes from one phase of the assault to another. PLs are less restrictive than objectives. They encourage the rapid exploitation of success without halting. Principal streets, rivers, and trolley or railroad lines make good PLs.
- **Checkpoints and contact points.** Street corners, buildings, railway crossings, bridges, and easily identifiable features can be checkpoints or contact points. They improve the reporting of locations. The commander can use them as specific points where he desires units to make physical contact.

## RAID

A raid is a deliberate attack into enemy-held territory for a specific purpose. Light infantry forces are ideal for conducting a raid. Raids are conducted with swift, violent action to destroy or capture enemy personnel or equipment, rescue friendly personnel, gain intelligence, or gain the initiative. Stealth during movement, indirect approach, violent execution, and precision are all characteristics of successful raids. The same considerations apply as for a deliberate attack, except for the following points:

- There is always a planned withdrawal from the objective.
- Planned fire and security elements isolate the objective from enemy reinforcement or retreat.
- Raids can be done by any size unit.
- Raids require detailed planning and extensive rehearsals.

The keys to the raid are information, surprise, and timing. Surprise is obtained by using deception, stealth, and speed of execution when moving to the objective area. It is essential that the raiding force arrive in the objective area without being compromised. Timing is also essential to the execution of the raid.

It is difficult to use light armor in the conduct of small unit infiltration raids. In some cases, however, the light armor platoon can be used as the security element to—

- Block enemy reinforcement along the mounted avenues of approach.
- Assist the raid party in breaking contact.
- Assist the raid party in the withdrawal from the objective.

The raid plan includes a signal to withdraw; well-planned routes to an ORP or rendezvous point; routes covered by preplanned fire; units assigned to cover the withdrawal and assist in breaking contact; a way to evacuate casualties, enemy prisoners of war (EPWs), and captured equipment from the objective; and an order of withdrawal from the objective.

The withdrawal from the objective and the security force blocking positions must be planned with the same detail as the rest of the mission. Use of preplanned fire is essential to keep enemy forces from pursuing. The enemy's anticipated reactions must be considered when planning withdrawal routes. Once the main body has withdrawn from the area, the security force withdraws. In some cases, the security force may have to withdraw using delay tactics.

## BYPASS

The company commander uses fire and movement when he decides to bypass enemy forces. The enemy is suppressed by both indirect and direct fires while the force moves, using covered and concealed routes, past the enemy positions. Where covered routes are not available, the M8s should remain out of antitank weapon range or use smoke to conceal movement.

While bypassing enemy forces, moving platoons orient gun tubes on the enemy. The M8 platoon (as the support by fire element) suppresses the enemy positions, thus preventing the enemy from firing on or maneuvering against the moving infantry platoons. The infantry unit may halt and provide suppressive fire so the support by fire platoon can move and complete the bypass (see Figure 4-48).

## CONSOLIDATION AND REORGANIZATION

The platoon should consolidate and reorganize as soon as it takes an objective. This is done so the platoon is prepared to destroy an enemy counterattack or to continue with the attack.

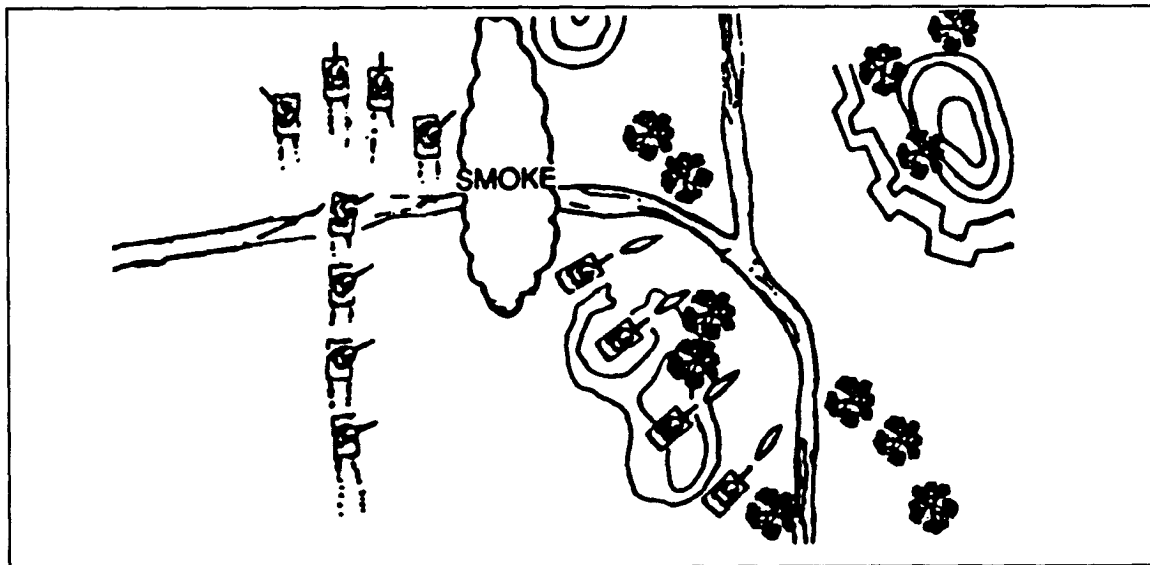

Figure 4-48. Bypass of an enemy position.

Consolidation consists of actions taken to secure an objective and to defend against an enemy counterattack. The commander designates platoon positions and weapon orientations. The platoon consolidates an objective by—

- Occupying the position designated in the OPORD. M8s are moved to hull-down positions, and the platoon leader assigns sectors of fire based on the commander's intent.
- Preparing for an enemy counterattack.
- Establishing security and mutual support between adjacent units.
- Eliminating any remaining pockets of enemy resistance and securing EPWs.
- Preparing to continue the mission.

Reorganization, the process of preparing for continued fighting, should be accomplished by SOP. The platoon leader, platoon sergeant, and vehicle commanders are responsible for the following actions:

- The platoon leader—
  - Redistributes personnel.
  - Oversees consolidation of personnel killed in action (KIA).
  - Informs the commander of the platoon's status.
  - Supervises essential maintenance.
  - Establishes communications with units that are out of contact.

- The platoon sergeant compiles status reports on personnel, equipment, and supplies from each vehicle and submits a consolidated report to the platoon leader and 1SG. He then directs cross-leveling within the platoon.
- The M8 commander—
  - Reloads machine guns and redistributes main gun ammunition to ready areas.
  - Moves wounded crewmen to a covered position and provides first aid.
  - Reports his situation, casualties, and status of equipment, ammunition, and fuel to the platoon sergeant.
  - Conducts essential maintenance.

## LIMITED VISIBILITY AND TERRAIN

**Limited Visibility.** Terrain and weather will not always be ideal for offensive operations. A platoon's ability to move, acquire the enemy, and control or request fires will be affected during periods of limited visibility. Equipment and training can help offset the effects. The platoon leader will have to adapt certain techniques or modify his tactics when operating under adverse conditions. This discussion covers the effects of limited visibility caused by adverse terrain or weather conditions and describes techniques for coping with these limitations.

The platoon often participates in offensive operations during periods of limited visibility. The concealment provided by adverse weather, nightfall, or smoke can favor the attacker by permitting him to mass forces and strike an unwarned enemy. The ability to surprise the enemy, plus the increased shock effect caused by an unseen attacker, may permit a smaller force to successfully attack and destroy a larger force.

During periods of limited visibility, the radio may become the primary means of communication. The commander decides whether visual signals—aided by the use of chemical lights, flashlights, or pyrotechnics—can provide secure, adequate communication or whether the radio must be employed.

When planning a night attack, commanders and leaders should make a detailed day and night reconnaissance of the route of march to the platoon points of departure. When a passage of lines is required, the reconnaissance should be conducted jointly with the passed unit at the passage point. Additional control measures such as direction of attack, probable line of deployment, and limit of advance may be used to aid in the C2 of an operation. Night operations using traditional illumination such as flares should be avoided. Flares may silhouette attacking forces or alert the enemy to the pending attack.

The following paragraphs describe some useful ways to offset the effects of limited visibility:

- Movement.
  - When navigation is degraded because of inability to see terrain features, a compass and the vehicle odometer are used to navigate.
  - The distance between vehicles should be decreased so that vehicle commanders can see each other to orient and provide overwatch. Crews can use white or luminous tape to outline unit marking panels. Flashlights, chemical lights, or dome lights can be fixed to the turret side or rear, the bustle rack, or the vehicle antenna. The column formation can also alleviate orientation problems. Platoons should employ traveling overwatch and bounding overwatch techniques internally when overwatch by another platoon is not possible.

- When natural obstacles (cliffs, holes, or cuts) are difficult to see, a detailed map study should be conducted before the operation to determine the best route. When moving with light infantry, the infantry can be used to move forward of the vehicles to reconnoiter. The column formation can minimize the chance of encountering unseen natural obstacles.
- Enemy acquisition.
  - In limited visibility conditions, the enemy may not be observed until he fires. Therefore, every movement must be overmatched. Elements should use the avenue of approach least likely to be watched by the enemy; this may cause him to shift his positions and give away his location. Every thermal or visual enemy signature, no matter how small, should be engaged. For example, the thermal signature of a tank commander's face may be the only detectable signature of a hull-down enemy tank.
  - Once a vehicle or section has located the enemy, it may have difficulty alerting the rest of the platoon. A steady burst of machine gun fire in the direction of the enemy can be used to orient the rest of the platoon to the direction and general position.
- Control of direct and indirect fires.
  - Limited visibility conditions or terrain may make it impossible for all of the vehicles in the platoon to see the enemy target. The platoon leader may not be able to determine which vehicles can engage before he issues a platoon fire command. After receiving the fire command, vehicle commanders who cannot see the target should report "CANNOT IDENTIFY" to the platoon leader.
  - When the platoon leader cannot determine a six-digit coordinate for the enemy position (for example, if he only sees muzzle flashes), he can use the shift from a known point method or polar method.

**Extremes of Terrain.** The following considerations apply to light armor employment in several types of difficult terrain:

- Forest and jungle. Heavy woods restrict the effectiveness of long-range fires and reduce M8 movement to trails, roads, and cleared areas. Since enemy infantry can operate freely in wooded areas and can surprise M8 positions, armored units must operate closely with infantry. For more information on jungle operations, see FM 90-5.
- Mountains. In rugged mountainous terrain, light armor forces are restricted to valleys and roads. From high ground, the enemy can engage the relatively thin armor on the top of the turret. Light armor units should operate with infantry when conducting operations in mountainous terrain. For more information concerning operations in a mountainous region, see FM 90-6.
- Arctic terrain and extreme cold. Extreme cold and its effect on men and equipment make operations in arctic terrain difficult. Thin ice, ice ridges, deep snow, and ravines hinder light armor movement. The absence of terrain features makes navigation difficult, and the intense white environment makes a camouflaged enemy difficult to see. For more information on arctic terrain and extreme cold, see FM 31-70.
- Desert. The desert may offer few covered and concealed positions. Once contact is made, units should return fire, continue to move, and use smoke to obscure themselves from enemy gunners. Moving units are exposed for longer periods and must use artillery, careful selection of routes, and high speeds to reduce exposure. Perceived ranges are distorted by the absence of terrain features. Targets that appear 2 or 3 kilometers



away may actually be 5 kilometers or more. Shapes are distorted by the effects of heat. The lack of identifiable terrain features also makes navigation difficult, especially at night. For more information on desert operations, see FM 90-3.

## Section V. Defensive Operations

This section describes the most common defensive missions conducted by the light armor platoon while operating with light infantry during defensive operations.

The light armor platoon operates with a light infantry battalion in closed terrain lacking in long-range observation and fields of fire. The light armor platoon, therefore, may not always be able to defend from BPs. Typically, the light armor platoon is used in the light infantry defense as a mobile reserve and counterattack force in the sector or antiarmor defense. Platoon BPs are used in strongpoint and perimeter defenses or in sector defenses when enemy armor or motorized avenues of approach exist.

### DIRECT FIRE PLANNING

The platoon defensive fire plan enables the platoon leader to distribute and control fires in support of the commander's defensive concept. It assists the commander in preparing his fire plan. If part of the platoon area is threatened, the platoon leader can use the fire plan to determine which weapon can cover the threatened area. Using radio or SOP signals, he can then direct fires to destroy the enemy.

To develop a defensive fire plan, the platoon leader must—

- Decide where to engage the enemy.
- Assign a location for vehicles and sectors of fire. A sector of fire is the area where an M8 has primary responsibility for acquiring and engaging the enemy. Sectors of fire should overlap between individual vehicles and with adjacent elements on the platoon's flanks.
- Designate TRPs and recommend indirect fire targets in the platoon sector. The company or battalion FSO assigns numbers to the indirect fire targets.
- Coordinate with adjacent units.
- Evaluate information from his vehicle commanders to determine if they can effectively observe and engage targets and TRPs within their sectors. Vehicle commanders prepare a sketch card for each position and give a copy to the platoon leader.
- Develop a sketch of the platoon's sector, with a list of direct fire engagements and a legend, for all primary, alternate and supplementary firing positions (see Figure 4-49). The sketch should include—
  - The platoon sector.
  - Individual vehicle positions.
  - OPs.
  - TRPs and EAs.
  - Obstacles.
  - Indirect fire targets.
- Give a copy of the platoon fire plan to the light infantry commander as well as to each of his MS commanders.

The legend lists targets in the sector and M8s that can fire on those targets. It should also explain the direct fire and indirect fire graphics, as well as obstacles and barriers within the sector of responsibility. The obstacles can assist in the defense by canalizing the enemy into an EA. Standard military symbols are used to depict the obstacles and barriers, which should be covered by direct or indirect fire.

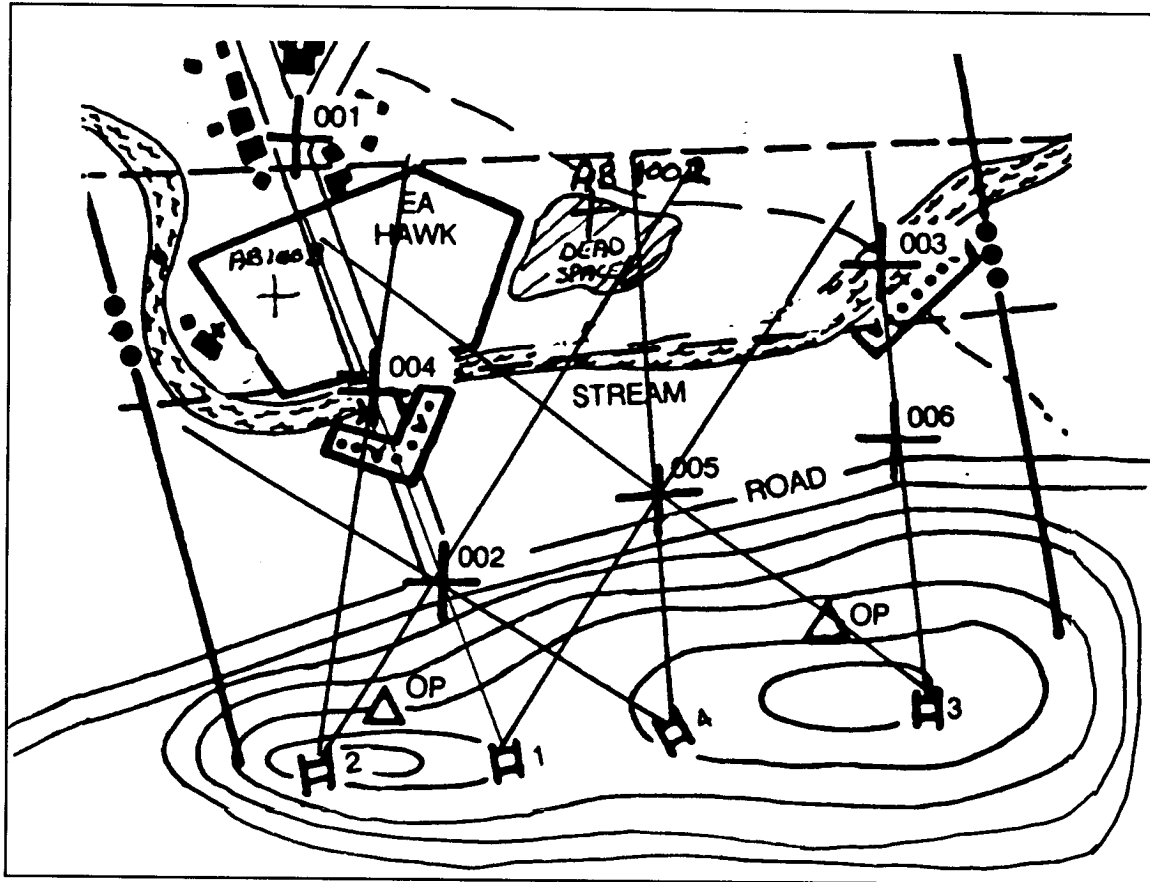

Figure 4-49. Light armor platoon sector sketch.

## PREPARATION

Ideally, the light armor platoon will be able to thoroughly prepare for defensive operations. It can conduct reconnaissance, position preparation, fire planning, and rehearsals. If possible, it occupies positions during limited visibility to mask preparations from the enemy.

Many tasks are accomplished concurrently. The infantry battalion commander may give priority to specific tasks based on his defensive plan. He may also need some advice for the employment of the light armor platoon. The light armor platoon leader is normally the senior armor advisor to the light infantry battalion commander. The following are the areas that the light armor platoon leader should consider when preparing for the defense. This list also includes issues the light infantry battalion commander may ask the platoon leader about.

**Establish Security.** The light armor platoon cannot provide its own security in close terrain. Mobility is a major factor in the survivability of the platoon. If the platoon must remain stationary to prepare defensive positions or in reserve, light infantry is needed to

## FM 17-18

secure the immediate area. MS crewmen are vulnerable to sniper attack when placed in closed terrain since the crewmen must usually unbutton to enhance visibility. The three-man crew characteristic of the MS considerably limits the platoon's ability to provide local security. Enemy light infantry will use stealth, darkness, and restrictive terrain to maneuver around armored vehicles; the enemy will then attack the vehicles with flank and rear shots using conventional antitank weapons as well as satchel charges, Molotov cocktails, and thermite grenades. In continuous operations, a dismounted force must be augmented to facilitate local security.

**Select M8 Positions.** The platoon leader will be the primary planner in choosing individual M8 positions. The platoon leader must understand the infantry commander's defensive plan and know what his targets are. He selects the location where he wants to kill the enemy and positions his M8s where they best support that location.

**Prioritize Targets.** The light armor platoon leader will most likely be responsible for executing a priority target if his position overmatches an obstacle, mounted avenue of approach, or other key point of the defense.

**Disseminate the Final Protective Fires (FPF).** The platoon leader must disseminate to the rest of the platoon the location of indirect targets and the FPF. This is important because the light armor platoon will probably have a key role in a counterattack by fire and/or maneuver.

**Distribute the Sector Sketch.** The platoon sector sketch, with individual M8 sector sketches, must be compiled and given to the infantry commander (company or battalion) and to adjacent units.

**Clear Fields of Fire.** If clear fields of fire do not exist, the platoon may be required to conduct some clearing on its own, or it may be assisted by engineers or infantry.

**Understand the Obstacle Plan.** Light armor platoons will normally not employ or plan the locations of obstacles, but they must have an understanding of the battalion commander's obstacle plan. The M8's long range and lethal weapon systems make it effective in overmatching obstacles (such as during a displacement) and preventing enemy breaching operations.

**Prepare Fighting Positions.** If engineer support is from division light engineers, digging assets may be limited, and light armor platoons may not be provided with standard fighting positions. Innovation may be necessary in constructing hasty fighting or hide positions; light armor may have to use existing terrain, buildings, or other means for protection. Corps engineer assets, when available, can construct two-tier fighting positions under the supervision of each tank commander.

**Establish Wire Communications.** Wire communications are maximized during the defense. Radio traffic must be minimized. Each vehicle should be linked by wire, and the platoon should be linked to its higher headquarters by wire.

**Stock Forward Supply Points.** The platoon leader should discuss the resupply plan with the battalion supply officer (S4) to ensure he can receive critical ammunition and fuel when needed. Caches of bulky supply items typical of light armor units should be constructed. The limited transportation assets organic to light battalions magnify the need to prestock during the preparation phase. The light armor platoon may have to help transport critical Class IV and V supplies from the caches to forward supply points or obstacle emplacement sites. Forward supply points should not be directly in front of fighting positions.

**Reconnoiter Movement and Counterattack Routes.** It is critical that the platoon leader, and each M8 tank commander, if possible, reconnoiter the route(s) established for movement or counterattack. Closed terrain may require accompanying infantry for security during movement. Heavy vegetation or defiles may slow the platoon's ability to execute rapid movement to a counterattack position. The leaders should rehearse the movement and determine the time required for the move.

**Prepare Alternate and Supplementary Positions.** M8s are usually the priority target of the enemy. Platoon leaders must identify alternate and supplementary positions to move to when receiving fire or covering other portions of an engagement area.

**Initiate Deception Measures.** Because the M8 is a valuable asset in the light infantry defense, the enemy will seek to identify these vehicles early. An ambitious deception plan may be needed to deny the enemy information relating to the size, location, and disposition of the light armor unit. Techniques for deception include use of decoy vehicles or sound effects (PSYOP units have loudspeaker sections that can be very easily prepared for this purpose) to disguise the actual positions or movement of the M8s. The visual and audible signatures of the M8 make it easy for the enemy to identify and locate in an environment that is dominated by dismounted forces. Leaders, however, can use this to their advantage as a deceptive measure during the preparation phase by positioning M8s in different areas of the defense.

## DEFENSE OF A BATTLE POSITION

When the terrain gives friendly forces the opportunity to defend from a BP, the light armor platoon uses the same defense as a tank platoon to control fires and movement. This defense is designed to concentrate direct fires at critical places and times to take advantage of available terrain. The light infantry battalion commander will assign the light armor platoon a BP when it dominates an armor or motorized avenue of approach.

The commander specifies critical tasks for platoons defending from BPs. A minimum level of preparation is assigned at each BP (occupy, prepare, or reconnoiter) to enable the platoon to accomplish its mission. The platoon orients its weapon systems on an enemy avenue of approach using designated EAs and sectors of fire established by TRPs. Other tasks may include—

- Destroying a specified enemy force, such as an enemy motorized company, from the BP.
- Controlling key terrain or blocking an avenue of approach by holding the BP against a determined assault.
- Reorienting weapon systems on a secondary or flanking avenue of approach from supplemental positions.
- Disengaging and moving to a subsequent BP when the enemy has passed a TRP or EA (break point) with a force of specified size.
- Assisting in any other task necessary to accomplish the infantry's mission (for example, assisting in passage of lines or reaming contact points).

The platoon positions its elements and maneuvers freely within the limits of the BP to accomplish the commander's intent. Engagement and disengagement criteria are included in the OPORD and must be understood by tank commanders. If the platoon leader must position elements outside the BP to make better use of terrain, increase dispersion, or maximize firepower, he coordinates locations with the commander (see Figure 4-50).

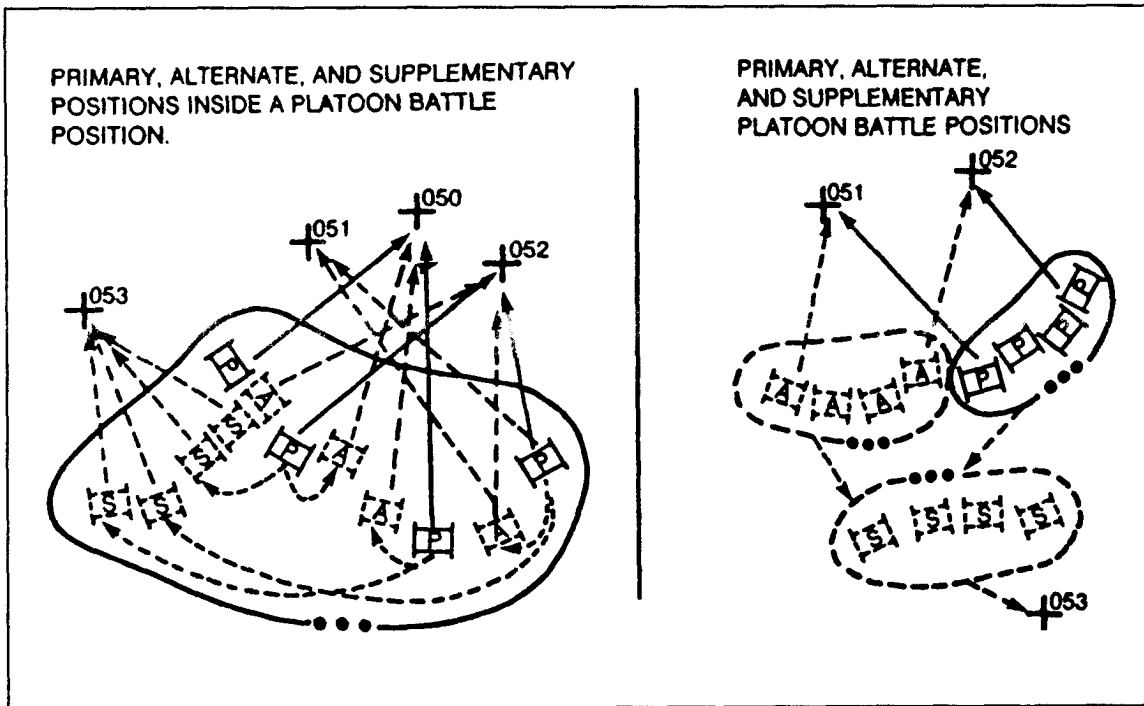

Figure 4-50. Platoon in a battle position.

### DEFENSE IN SECTOR

The purpose of a defense in sector is to destroy the enemy force forward of a rear boundary. A light armor platoon is not usually assigned a defense in sector mission when defending as part of a light infantry TF. A platoon is assigned a defend in sector mission as part of a light armor company team when—

- The enemy situation is vague.
- Multiple avenues of approach in company areas of responsibility cannot be covered by mutually supporting platoon BPs.
- Retention of terrain is not critical to success of the defense.
- Maximum flexibility is desired.

When defending in sector, the platoon uses mutually supporting fires to destroy the enemy, moves and concentrates fires to disrupt and destroy enemy formations, and counterattacks as needed to accomplish the mission. The platoon leader must correctly identify potential enemy avenues of approach entering his sector from the front, flanks, and rear. As in planning a BP, the company team commander selects tentative weapon positions to cover these avenues with fire and observation. He allocates space to platoons, giving them BPs, sectors, or a combination of both. If absolutely necessary, he task organizes platoons based on his estimate.

In a defend in sector operation, the antiarmor defense allows for planned penetrations, counterattacks, and ambushes throughout the enemy formation. The antiarmor defense is used against a superior armored or motorized enemy in close terrain. It is the most offensively oriented defensive technique that light infantry can employ. The battalion is

assigned a sector by brigade. The battalion commander analyzes his sector according to the estimate process. He may in turn assign sectors to his companies, or he may assign some companies sectors and some BPs. The sector is organized to make maximum use of dispersed small-unit tactics (down to squad level) to attack the enemy throughout the depth of his formations.

The primary focus of the technique is on the enemy force; it prevents the attacker from focusing full combat power at one point. Its goal is to reduce enemy forces by attrition with a series of antiarmor ambushes. The light armor platoon can be used in this mission to concentrate firepower or as a mobile reserve to exploit success or defeat enemy penetrations. Figure 4-51 shows an example of a light infantry battalion antiarmor defense.

With some slight adjustments, this technique can be used—

- To deny the enemy the use of a trail or road network in an area of restrictive terrain.
- To deny a chokepoint to the enemy. This could be a mountain pass, a bridge crossing, or a highway through wooded terrain.
- To deny the passage of dismounted infantry or infiltrating guerrilla forces through close terrain.
- To defeat a motorized enemy that is attempting a move through restrictive terrain.

## REVERSE SLOPE DEFENSE

A reverse slope defense is organized to use a topographical crest to mask the friendly force from enemy observation and supporting fires. Figure 4-52 illustrates organization of this defense. The battalion commander may adopt reverse slope positions for defensive elements when—

- Enemy fire or lack of cover and concealment makes occupation of the forward slope dangerous or tactically infeasible.
- The forward slope has been lost or has not yet been gained.
- The forward slope is exposed to enemy direct fires from beyond the effective range of the defender's weapons. Moving to the reverse slope removes the attacker's standoff advantage.
- The terrain of the reverse slope affords better fields of fire than are available on the forward slope.
- The defender must avoid creating a dangerous salient or reentrant in friendly lines.
- The commander wants to surprise the enemy or deceive him as to the true location of the battalion's defensive positions.

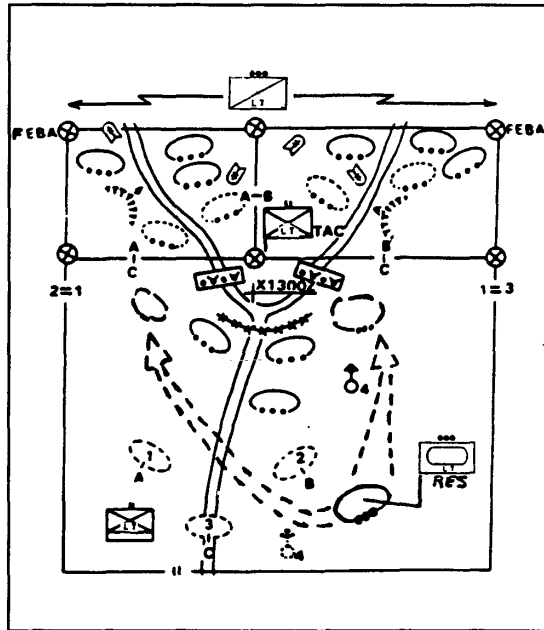

Figure 4-51. Light infantry battalion antiarmor defense.

Advantages of the reverse slope defense include the following:

- Enemy ground observation of the battle area is masked, even from surveillance devices and radar.
- Enemy direct fire weapons cannot effectively fire on the position without coming within range of the defender's weapons.
- The enemy is forced to try to breach obstacles on the reverse slope within direct fire range of the defender's weapons. The attacker cannot locate these obstacles until he runs into them.
- The enemy can be deceived as to friendly strength and location.
- Enemy indirect fire is less effective.
- The defender gains tactical surprise.
- The lack of enemy ground observation allows more freedom of movement within the battle area.
- If positions are properly positioned, M8s, Dragons, TOWs, and MK 19s can mass fires on the reverse military crest; infantry small arms can contribute their close fires to the battle.
- The unit can dig in more quickly, even when enemy ground forces are approaching, because the slope of the hill covers and conceals the unit from direct fire and observation. Defenders can make more thorough position preparations.
- The terrain protects the unit from the blast and thermal effects of enemy and friendly nuclear weapons.

Disadvantages of a reverse slope defense include the following:

- Observation of the enemy may be limited, and the defender may be unable to cover obstacles to the front with direct fires.
- The range of vital direct fire weapons such as M8s and TOWs may be limited by the topographical crest; they also may have to be positioned away from the infantry to exploit their range.
- The enemy will be able to attack downhill from high ground, while a friendly counter-attack will be uphill. This may provide a psychological advantage to the enemy.
- Effectiveness of this defense is reduced in limited visibility because the reverse military crest must be controlled.

The battalion commander organizes the reverse slope defensive position in accordance with procedures and considerations that apply to all defensive techniques. The forward edge of the position should be within small arms range of the crest; however, it should be far enough from the crest that fields of fire allow the defender time to place well-aimed fire on the enemy before he reaches friendly positions. The reverse slope position is most effective when the forward slope can be covered by flanking fires from units on adjacent terrain.

A security force should be established to the front of the position to stop or delay the enemy, disorganize his attack, and deceive him as to the location of the position. When this security element is withdrawn, observation, indirect fire, and security must be maintained to the front. OPs are established on or forward of the topographical crest. This allows long-range observation over the entire front and makes it possible to cover forward obstacles with indirect fires. OPs are usually provided by the reserve; they may vary in size from a few soldiers to a reinforced squad. They should include forward observers. At night, the number of OPs should be increased to improve security.

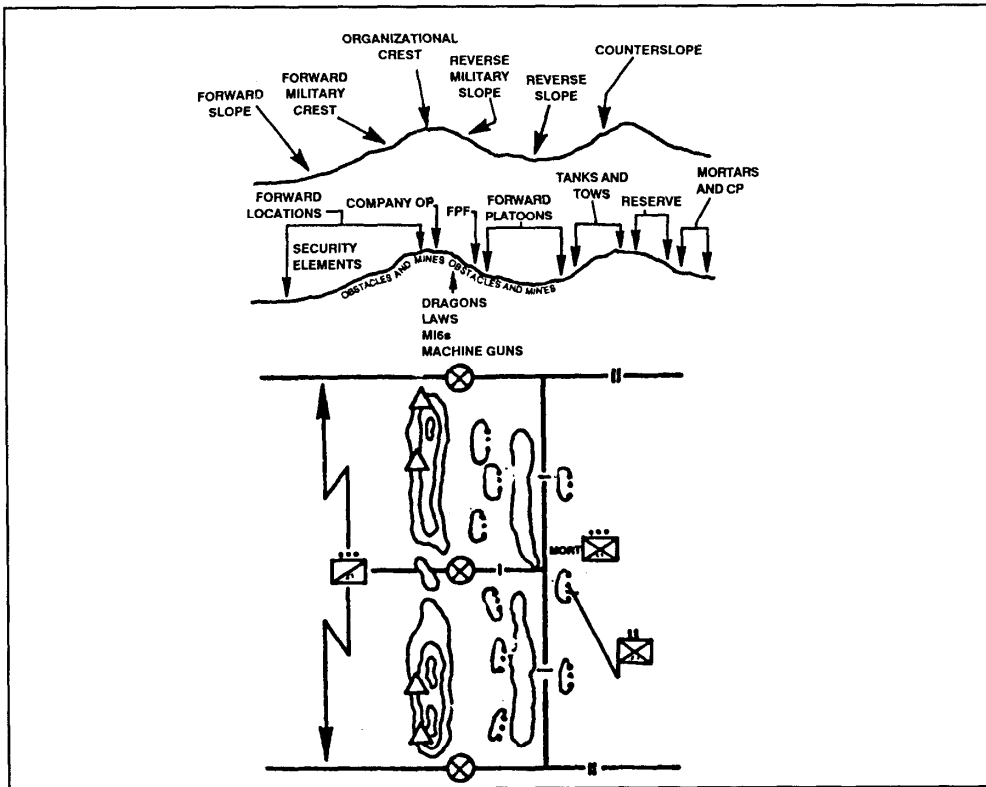

Figure 4-52. Organization of a reverse slope defense.

Conduct of the reverse slope defense closely parallels that of a forward slope defense. M8s, TOWs, and MK 19s may be positioned first on the forward slope to engage the enemy at long ranges. As the enemy nears, they move to positions on the reverse slope or on the forward slope of the next hill to the rear (counterslope).

The reverse slope defense can be adapted to fit a particular tactical situation based on the factors of METT-T; examples are illustrated in Figure 4-53. Possible adaptations include the following:

- Firing positions are prepared on or forward of the topographical crest when the commander wants to use the fields of fire afforded by the forward slope. Most personnel remain on the reverse slope to reduce their exposure to fire; only a skeleton force is kept forward to slow the attacker while the remainder of the friendly force occupies reverse slope fighting positions. Reserves (such as a light armor platoon) are held in covered positions. These forces are used for counterattacks around the flanks of the hill.
- The enemy may be denied the hill or suffer high casualties fighting for it even if neither the forward slope nor the reverse slope is suitable for a BP. The defender can engage the enemy on the reverse slope from positions on other hills. Mortars, artillery, and long-range machine gun fires are targeted on the reverse slope, the crest, and the forward slope. Positioning elements on flanking hills often allows grazing machine gun fire against otherwise protected areas just over the crest.



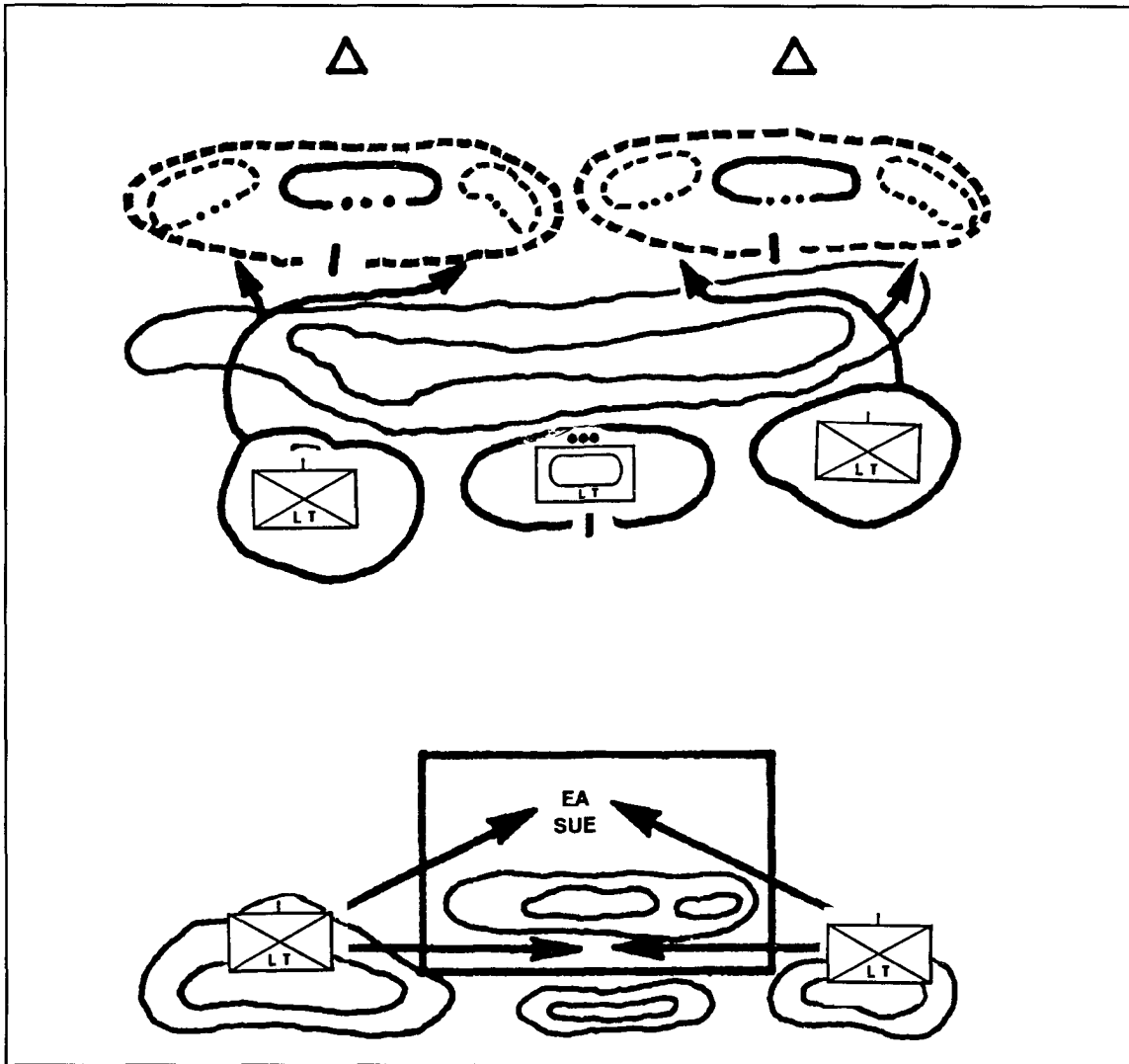

Figure 4-53. Adaptations of the reverse slope defense.

## PERIMETER DEFENSE

This is conducted in the same manner as defense of a BP except the perimeter defense orients on 360 degrees. The perimeter defense is often used as a light infantry technique. The light armor platoon participates in the perimeter defense as part of the light infantry TF defense. Perimeters may be used to defend—

- Assembly areas (refer to FM 17-15 for AA procedures).
- Specific installations or equipment (TOC, downed aircraft, bridges, airfields, road blocks).
- Key terrain (bridge, hilltop, pickup zone, landing zone, lodgement area).
- As part of a brigade perimeter, airhead, or lodgement.

While a BP can allow some penetration, a perimeter cannot. Perimeter defenses are used to protect the force, hold specific terrain, or protect a key installation from destruction. Flanks of all units are tied in to provide mutual support, and positions are planned in depth. If the perimeter is penetrated, the light armor platoon can be used to block the penetration or to counterattack to restore the perimeter. M8s are positioned on the most likely enemy mounted avenues of approach. Mortars are usually positioned in the center of the perimeter and can fire 360 degrees.

Patrols are used to provide security to the light armor platoon. Using the M8 platoon in the perimeter defense provides flexibility to counterattack in any direction, allows occupation and control of a specific area, and provides ease of control.

## **STRONGPOINT DEFENSE**

A strongpoint is a defensive position that is fortified as extensively as time and materials allow. It is used to hold key terrain critical for the defense, to provide a pivot for the maneuver of friendly forces, and to canalize the enemy into friendly EAs. A strongpoint may be part of any defensive plan. It may be built to protect vital units or installations, as an anchor or anvil around which light armor units maneuver, or as part of a trap designed to destroy enemy forces that attack. It may be in an urban area or in a wilderness.

A strongpoint is attacked at the risk of high casualties. It cannot easily be overrun or bypassed. It is tied in with existing obstacles, forcing the enemy to reduce it by dismounted assaults and massive artillery and tactical air concentrations.

While the size and type of force selected to execute a strongpoint defense will vary according to the situation, an infantry unit is normally used, with light armor retained for mobility. A unit required to defend a strongpoint will need a significant amount of time and engineer resources to construct the position. Defense of a strongpoint is sometimes an extension of a defense of a BP. Depending on the commander's intent, BPs can be developed into strongpoints if time, terrain, and resources allow.

The strongpoint must be planned so that it can be reduced only with the expenditure of overwhelming forces and much time. Each primary, alternate, and supplemental position must be dug in. Positions should be connected by tunnels or trenches if time permits. Each individual vehicle position must be connected by wire to the platoon leader's position, and the platoon and section leaders' positions must be wired into the infantry commander's position. The wire must be dug in to protect it from enemy indirect fires. This can be accomplished by laying wire through sewers and tunnels or by burying it.

Direct fire plans should provide mutual support and overlapping fires to the greatest extent possible. To reduce vulnerability, primary positions and sectors of fire are augmented by alternate and supplemental positions and sectors of fire.

Because of the nature of the operation, strongpoints are located in restrictive terrain, such as urban areas, mountains, and thick forests that cannot be easily bypassed. Since the unit must prevent the enemy from bypassing or reducing the strongpoint, priority tasks for engineers are countermobility and survivability.

Light infantry units may be directed to construct a strongpoint as part of a larger overall defensive plan. They must be augmented with extensive engineer support, additional key weapon systems, pioneer tools, additional transportation assets, and CSS resources. To offset some of the support requirements, the commander may decide to take advantage of an existing obstacle, such as a town or village, to reduce the time required to develop a strongpoint.

## FM 17-18

The following critical aspects of the strongpoint defense should be incorporated into the overall plan:

- Covered and concealed routes are constructed or planned between positions, along routes of supply and communication, and to support counterattacks and maneuver within the strongpoint.
- Food, water, ammunition, pioneer tools, and medical supplies are stockpiled in each fighting position.
- The strongpoint is divided into several independent but mutually supporting positions or sectors. If one of the positions or sectors must be evacuated or is overrun, obstacles and fires limit the enemy penetration and support a counterattack by M8s.
- Obstacles and minefield are constructed to disrupt and canalize enemy formations, to reinforce fires, and to protect the strongpoint from assault. The obstacles and mines are placed as far out as friendly units can observe and cover with fire, within the strongpoint itself, behind the strongpoint, and at points in between where they will be useful.
- Several means of communication within the strongpoint and with higher headquarters are planned and tested. These include radio, wire, messenger, pyrotechnics, and other signals. The strongpoint is improved or repaired until the unit is relieved or withdrawn. Additional positions can be built, tunnels and trenches dug, existing positions improved or repaired, and barriers built or fixed.
- The strongpoint position itself must be an obstacle to enemy mounted movement.

## DEFENSE IN BUILT-UP AREAS

A small, well-organized, determined force defending a BUA can hold off a much larger attacker for long periods of time. Strongly constructed cities give the defender a decided advantage. Each building or group of buildings is a potential strongpoint for light infantry.

The light infantry battalion combines BUA techniques with the elastic and strongpoint defensive techniques. The urban defense may force the enemy into planned EAs that are covered by antiarmor or light armor platoon BPs. Forward BPs or covering forces may be employed to disorganize and confuse the enemy as to the main defenses. Behind the BPs, defenses are set up to protect the friendly support element and stop the deepest penetration of the attacking force. Light armor may be located within this defense, on the flanks in BPs, or as a mobile counterattack force.

Light infantry battalions are employed in the urban defense to block the penetration of the enemy and to protect friendly logistics elements. The keys to success in this defense are surprise, effective use of terrain, protection, and coordinated massing of fires. An example of a light infantry urban defense with M8s is shown in Figure 4-54.

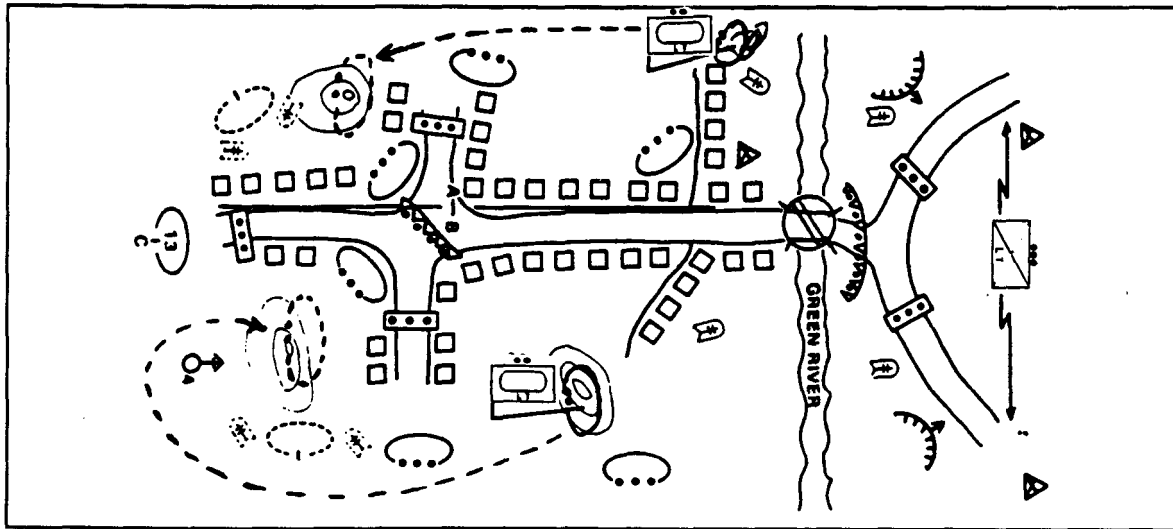

Figure 4-54. Example of light infantry urban defense with M8s.

Light infantry commanders should consider the following when integrating light armor into the urban defense plan:

- Light armor BPs must be positioned to mass their fires on the enemy from multiple directions to maximize destructive capability while minimizing vulnerability to enemy attacks.
- M8 fires must be included in the obstacle plan and counterattack plan.
- Use destroyed BUAs as obstacles when they give significant advantage to the direct fire plan.
- If terrain permits, light armor defenses can be established forward of a BUA.
- Adjacent terrain can be used to integrate M8s into the defense.
- Use light armor to assist security forces in limiting enemy ground reconnaissance and infiltration.
- Use obstacles, mines, and antitank augmentation to prevent enemy armor penetration of BPs.
- Use restrictive missions and detailed control measures to facilitate decentralized execution and prevent fratricide.
- Light armor leaders must know what passive resistance measures have been taken along the enemy's avenue of approach. Passive resistance includes removing route indicators and minefield markers and weakening bridges and culverts. M8 commanders must know these plans. Failure to know what passive measures have been taken may cause unnecessary mistakes and/or injury to M8 crewmen.
- Light armor leaders must be aware of patrol plans to prevent firing on friendly units. Extensive infantry patrolling is conducted to prevent enemy infiltration. Long- and short-range recognition signals should be incorporated into the security plan.
- Some M8s may be held in reserve to counterattack enemy attempts to envelop the town, while others provide direct FS for the infantry defense.
- LOCs must be controlled to provide the M8s with medical evacuation and resupply of Classes I, III, and V.

Use of M8s in defensive street fighting is limited. Streets and alleys provide limited fields of fire. Restricted observation and the proximity of friendly troops to enemy targets will limit the use of armor fires. However, when the town itself occupies the dominating terrain in the vicinity, it may be organized as a key part of the BP or strongpoint.

When the town itself is organized as a defensive position, light armor commanders select primary, alternate, and supplementary positions. Because observation in BUAs is greatly restricted, OPs should be set up and communications improvised between them and the M8s. These OPs should not be placed in steeples, prominent towers, or other obvious locations which the enemy is likely to suspect and take under fire.

Light armor unit commanders, when reconnoitering for covered routes of advance and withdrawal, should not overlook the possibility of moving through ground-floor lobbies and corridors of the larger buildings. This type of route requires careful marking, but has the advantage of being largely concealed from aerial observation. A careful reconnaissance, made with engineer assistance, if possible, is necessary to determine whether the floors will support the M8.

## **RESERVE FORCE**

Early in the planning stage, the commander makes important decisions concerning the size, composition, and mission of the reserve. The primary purpose of the reserve is to retain flexibility, reinforce success, or regain the initiative through counterattacks. Secondary purposes of the reserve are—

- To contain or counterattack enemy forces that have penetrated.
- To relieve depleted units and provide for continuous operations.
- To attack enemy forces not yet in contact.
- As a last resort, to react to rear area threats.

A light infantry battalion conducting a deliberate attack may initially retain a light armor platoon in reserve. A reserve is held to exploit success and continue an attack already under way, to maintain momentum of an attack by adding an armor unit at a critical time, and to provide security. The reserve is an active, not reactive, force and is not used to reinforce failure.

When employed in a positional defense, such as perimeter defense or a BP, light armor reserves can be used to conduct attacks against enemy penetrations by striking a decisive blow against an uncovered enemy flank. Additionally, should the enemy's attack fail, reserves could be used to regain initiative.

## **COUNTERATTACK FORCE**

The platoon may participate in a counterattack to exploit an existing enemy weakness in the AO. An element counterattacks to—

- Destroy enemy units.
- Regain freedom of maneuver.
- Regain the initiative.
- Regain key terrain.
- Relieve pressure on an engaged unit.

A platoon executes two types of counterattacks which are discussed in the following paragraphs.

**Counterattack by Fire.** A counterattack by fire is executed to complete the destruction of exposed enemy elements, to free decisively engaged elements, and to regain the initiative. The platoon executes a counterattack by fire by moving on a secured, concealed route to a predetermined BP from which it can engage the enemy in the flank and/or rear while other units hold their positions and continue to engage and maintain contact with the enemy (see Figure 4-55). When necessary, the platoon leader requests permission to maneuver outside the predetermined BP by prior planning, coordination with the commander, or immediate request. If this maneuver influences another unit's mission, the commander is responsible for coordination with that unit.

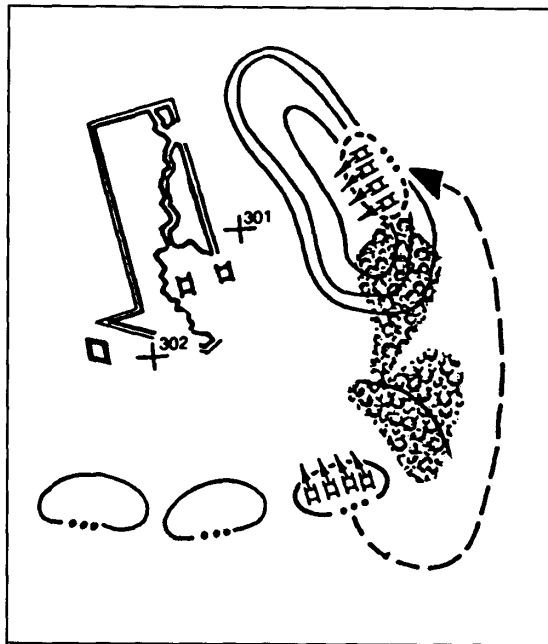

Figure 4-55. Counterattack by fire.

**Counterattack by Fire and Maneuver.** A company team normally uses counterattack by fire and maneuver to destroy remaining enemy elements completely, relieve pressure on a friendly unit, or regain key terrain. The counterattack force hits the enemy on the flank if possible, using fire and maneuver to overwhelm and destroy him. A platoon counterattacks by fire and maneuver in a manner similar to a hasty attack (see Figure 4-56).

## LIMITED VISIBILITY

Although limited visibility creates opportunities for deadly close-range engagements that will achieve surprise, the possibility that the enemy may pass the platoon's position or close to point-blank range must be considered in planning the defense.

The fundamentals of defensive operations do not change with limited visibility. Depending on the situation, the light armor platoon should—

- Occupy dominating positions along avenues of approach when visibility is good, and reposition closer to or occupy the avenues of approach during periods of limited visibility.

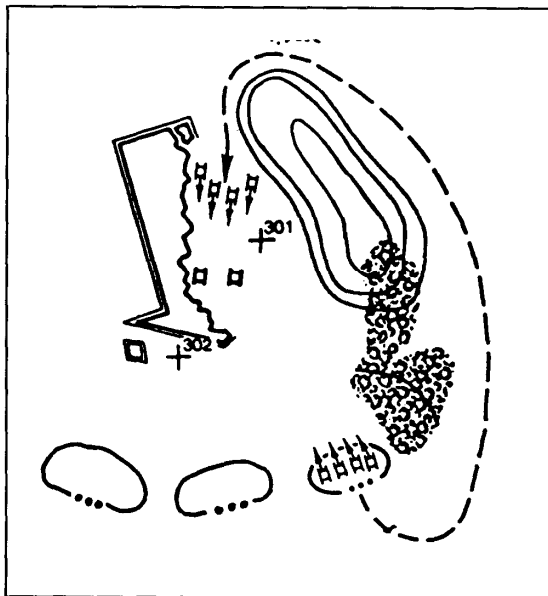

Figure 4-56. Counterattack by fire and maneuver.

- Reconnoiter the limited visibility positions, mark them, and mark the routes to them.
- Incorporate the use of night-vision devices (NVD) in the platoon fire plan and plan for indirect illumination to supplement passive image intensification or infrared night sights.
- Request additional security forces, such as light infantry squads, to compensate for lack of traditional organic manpower because of the M8s' three-man crews.
- Enforce noise and light discipline.
- Ambush as far forward and as many times as METT-T factors allow.

## Section VI. Other Operations

### LODGEMENT

The lodgement area is a designated, secure area that permits the air or sea landing of follow-on forces and provides the maneuver space needed for planned operations. The lodgement area is established by force or by a host nation.

After the initial insertion, the lodgement area is expanded. Expansion is usually followed by a defense until enough forces arrive to initiate offensive operations. Forces may include CS and CSS elements as well as some corps or JTF assets.

Planning for defense of a lodgement area is similar to establishment of an airhead. When ordered to establish and defend a lodgement area as an independent operation, the light infantry commander plans—

- Task organization.
- Assault objectives.
- An airhead line and unit boundaries.
- Reconnaissance and security.
- Follow-on forces.
- A reserve.

There are two basic types of lodgement operations, an opposed entry and an unopposed entry. Airborne infantry and light armor are employed in opposed entry lodgement operations; light infantry and light armor forces are specifically designed for unopposed entry lodgement operations.

**Opposed Entry.** The opposed entry lodgement begins with the seizure of one or more airfields. Seizing airfields facilitates the rapid introduction and buildup of combat forces needed to conduct further actions.

The phases of airfield seizure include the following:

- Seizing key facilities and eliminating the enemy direct fire threat. The light armor platoon, task organized to the assault TF, usually assaults directly onto the airfield, assembles rapidly, and moves to seize assault objectives and/or supports infantry assaults by fire. Light armor platoons may be required to destroy enemy bunkers and fortified positions, eliminate roadblocks, or support assaults of buildings on the airfield.
- Isolating the lodgement from enemy reaction and indirect fire. Light armor platoons that follow the assault may participate in movement to contact to eventual establishment of a screen (airhead line) to isolate the airfield from observed indirect fires and block access by motorized or armored enemy forces. M8s may be required to assist in removing obstacles and towing vehicles from runways to allow follow-on aircraft to land.

- Receiving follow-on forces that arrive by airlanding. Light armor platoons arriving in the follow-on echelons act as reserve forces and, eventually, as offensive forces to accomplish objectives of the campaign.

An airborne light armor platoon is task organized to an airborne infantry TF to seize an airfield. The battalion is usually part of a brigade-size TF that includes a light armor company.

**Unopposed Entry.** An unopposed entry is usually executed at the request of the host nation. Advance parties are sent ahead of the main body to make face-to-face coordination with host nation forces. Coordination may also be required with SOF or other units in the area. Characteristics of planning by the staff include—

- A movement plan that identifies when each element moves and where it is located.
- A small advance party to assist in the orderly movement of vehicles from the carrier to an assembly area.
- Preparations for quick transition to combat operations.
- Identification (on operations overlays) of enemy elements that affect the entry unit (or, as a minimum, enemy forces operating in the AO).

Once the unopposed force is assembled at the arrival airfield, it operates and conducts missions as directed by the parent headquarters. The tasks assigned to light armor for expansion, security, or offensive action are dependent upon the overall objectives and situation.

## RETROGRADE OPERATIONS

This discussion deals with the retrograde missions that light armor platoons may conduct as part of a light infantry TF or light armor company. To conduct a retrograde operation, the light infantry unit must have mobility equal to or greater than that of the enemy. Light infantry can conduct retrograde missions against a light threat. Light armor units give the light infantry the capability to conduct retrograde operations against a mounted or large dismounted threat.

**Delay.** The purpose of a delay is to slow the enemy or draw him into an unfavorable situation by trading terrain for time while inflicting maximum damage. Enemy forces are delayed by the effective use of obstacles, firepower, and terrain. Delaying forces avoid decisive engagement. The delay can be oriented either on the enemy or on specified terrain.

When conducting the delay, friendly forces must always consider the intent of the commander. The light armor platoon conducts a delay as part of a larger unit. A light infantry battalion conducting a delay may require the platoon to attack, defend, screen, ambush, raid, or feint. The considerations of planning and executing a delay at platoon level are the same as for defensive operations, with emphasis on—

- Avoiding decisive engagement.
- Avoiding being outmaneuvered.
- Causing the enemy to conduct successive attacks.
- Preserving the freedom to maneuver.
- Preserving the force.

Light infantry battalions delay aggressively, but because of the limited range of their organic weapons, they cannot delay continuously. They delay the enemy by engaging him



from the front, flanks, and rear with multiple ambushes and surprise attacks. They can use artillery, mortar, and M8 fire to disrupt the enemy's movement, causing him to take cover and move more cautiously. Friendly forces then withdraw to alternate positions to engage the enemy again; as they do, part of the delaying force may stay behind and continue to aggressively engage subsequent enemy echelons and CS and CSS elements.

Enemy-oriented delays focus on keeping the enemy from advancing faster than a specified rate. Control measures that are most often used in this type of operation include the following:

- **PL.** The commander specifies that the enemy is to be held beyond the PL for a specified time or until a specific event occurs.
- **Sector.** As in the defense, the sector allows wide latitude in the conduct of the delay. PLs can be used with sectors if the commander desires more control.
- **BP.** BPs can be used with phase lines and sectors or alone. In the delay, a unit fighting from a BP must be able to stop the enemy's advance along his most likely avenue of approach, not just deny access to the position it occupies. Units can delay from successive positions or alternate positions. Light infantry can delay from successive positions only if it has a mobility advantage over the enemy or the enemy advance is not aggressive. Once light infantry leaves prepared positions to move, it is vulnerable. This vulnerability is increased if the enemy is not suppressed as the light infantry moves. Light armor can be used to provide this suppression.

Terrain-oriented delays require the retention of specified terrain for a specified time or until a specified event occurs. They are often vital to continued friendly operations in a given area; however, they carry the risks inherent in any mission that requires delay until a specified time or event.

**Withdrawal.** The purpose of a withdrawal is to disengage from the enemy. Light infantry needs equal or greater mobility than the enemy to successfully conduct a withdrawal. There are two types of withdrawals—a withdrawal under enemy pressure and a withdrawal not under enemy pressure. A withdrawal under enemy pressure requires maneuver to break contact. In this case, the unit is under attack from the enemy. Withdrawal not under enemy pressure requires deception and speed. The unit is not under attack and does not expect to be attacked during the withdrawal.

During a withdrawal, deception and operational security are stressed. A unit conducting a withdrawal not under enemy pressure from a defensive position is organized into a main body and a DLIC. A unit conducting a withdrawal under enemy pressure is organized into a security force and a main body. The withdrawal should always be conducted to preclude discovery. Timing is critical. The unit must disengage by using massed fires and redeploy before the enemy can react to its movement. Light armor platoons can assist the light infantry in conducting withdrawals.

The withdrawal plan must be modified to fit the technique used to defend or delay. Defense or delay techniques that are fluid and use a series of ambushes and raids to accomplish the mission can use withdrawal techniques associated with those operations. Defenses or delays that are more static require different withdrawal techniques. The techniques used for a unit to withdraw from a BP must be enhanced by a plan that addresses the elements discussed in the following paragraphs.

**The DLIC.** The size, makeup and mission of the DLIC is directed by the battalion commander. He will also name the DLIC commander. This is normally the battalion XO.

Although one company could serve as the DLIC, the light armor platoon can also be part of the battalion DLIC, which may include TOWs from the antiarmor platoon or company to provide further mobility. The DLIC usually includes infantry squads, which must be moved on the M8s or HMMWVs. When the withdrawal starts, the DLIC comes under control of the DLIC commander.

**The Security Force.** The M8 platoon can assist as part of the security force, which conceals the withdrawal of the main body and deceives the enemy by continuing the battalion's normal operational patterns. If the enemy attacks during a withdrawal, the security force covers the withdrawal with fires. Priority of artillery and mortar fires is given to the security force. Once the battalion has reached its next position or a designated distance from the old position, the commander withdraws the security force. If under attack, the security force may have to maneuver to the rear until contact is broken.

**The Quartering Party.** Each unit sends a quartering party to the next position before the withdrawal starts. As their units arrive at the new location, members of the quartering party act as guides to lead elements into their new positions.

**Retirement.** In a retirement operation, a force not in contact moves away from the enemy to avoid combat under unfavorable conditions. A retirement may be made to increase the distance between the defender and the enemy, to occupy more favorable terrain, to reduce the distance between maneuver and CSS elements, to conform to the disposition of a higher command, or to permit employment of a unit in another sector. A withdrawal becomes a retirement after the main force has disengaged from the enemy and march columns have been formed. A battalion usually conducts a retirement as part of a larger force.

The prospect of retirement may have an adverse impact on unit morale. Leadership must be positive, and discipline must be maintained. Rumors related to the retirement can be stopped by keeping troops informed of the purpose of the retirement and the future intentions of the leaders.

Planning considerations for a retirement are similar to those for delay and withdrawal. Movement during reduced visibility is preferred. Light infantry battalions usually seek to move on multiple routes for reasons of dispersion, speed, and security. This may require the light armor platoon to split into sections to support each route.

Appropriate advance, flank, and rear security is provided. When contact with the enemy is possible, such as when a withdrawal has preceded retirement, a light armor security force should be employed. If the enemy attacks the rear, delay tactics are used by the light armor platoon to extend the distance between the main body and the enemy.

## RECONNAISSANCE IN FORCE

The purpose of a reconnaissance in force is to discover and test enemy dispositions, composition, strength, and intentions. The decision to reconnoiter in force is made after analyzing—

- The enemy situation and the need for additional information.
- The ability of other collection agencies to gather the desired information.
- The extent to which future plans may be revealed to the enemy.
- The possibility that the reconnoitering force may be engaged under unfavorable conditions.

Although a reconnaissance in force is an effective means of developing information about the enemy, it should not be undertaken if the information can be acquired through other sources. The possibility of having a portion of the force engaged under unfavorable conditions must be a primary concern in planning.

A battalion is normally the smallest light infantry unit to conduct a reconnaissance in force. It may be employed in such a role independently or as part of a larger force. The light armor platoon participates in the reconnaissance in force as a maneuver or FS force. Light armor used in this mission may only be effective against an armored, mechanized, or motorized threat.

If a light infantry battalion is the reconnoitering force, it plans and executes either a movement to contact or an attack. The force must be strong enough to make the enemy react, revealing weapons, positions, and planned use of resources. The mission assigned to the unit may be to—

- Secure a terrain objective that will force the enemy to react, and then to prepare to continue the attack from that objective.
- Occupy a terrain objective that will force the enemy to react, and then return to friendly positions.

### CONVOY SECURITY

Light armor platoons can provide convoy security, which is a challenging mission in operations other than war. Supply convoys are high-payoff targets for guerrilla forces who may lack the firepower to fight the force conventionally. Successful interdiction of supply lines can significantly weaken the force.

Convoy escort missions require the same tactical considerations as any offensive operation. Protection of the convoy is a combined arms effort. The light armor platoon provides the light infantry commander with mobility, firepower, and shock effect. Light armor platoons can conduct security alone, or with other elements such as MP and infantry TOW/MG HMMWVs. Organic field artillery units provide indirect FS along the entire route. Air reconnaissance aircraft can provide aerial reconnaissance and/or FS.

The convoy commander is responsible for the overall planning and execution of the convoy operation. After the operation, the convoy commander should complete the local unit convoy debrief checklist and/or debrief the TF commander and S2 to provide input into the intelligence collection effort. The convoy commander must consider the following when planning a convoy security mission:

- Convoy organization, spacing, and weapons orientation.
- Communication plan (including air, FS, and long range).
- Timetables for movements.
- Graphic control measures, including friendly units along the entire route, SPs, and RPs.
- Security required during maintenance (including breakdowns), resupply, and rest halts.
- Where combat assets will be positioned in the convoy to best protect the convoy.
- Actions under hazardous weather conditions.
- Actions on contact with the enemy and/or a minefield or obstacle.
- Actions on a delay caused by the local populace, such as a nonoperational vehicle blocking the road.
- Fire control measures and ROE.
- Primary and alternate routes.

Light armor is well suited to protect convoys by deterring enemy ambushes or snipers. If deterrence does not work, the M8 has the firepower and protection to eliminate the attacker.

The makeup of the force allocated to provide convoy security is based on the size of the convoy and METT-T. The TF commander task organizes the forces available to provide the necessary security and then appoints a convoy commander. MP platoons supporting a light infantry brigade may be sufficient. When needed, light armor may provide convoy security; such force may range from an M8 section augmenting an MP platoon to a full light armor company team providing the support.

The convoy commander is responsible for the overall planning and execution of the convoy operation. The convoy security force is the operational control (OPCON) for the convoy commander. He receives a mission, conducts a reconnaissance, plans the operation, issues orders, inspects personnel and vehicles, and synchronizes security. The convoy security commander may be a light armor company commander, platoon leader, military police (MP) platoon leader, or M8 section noncommissioned officer (NCO), depending on the size of the convoy.

Convoy escort missions generate unique circumstances that the convoy commander must take into account when formulating his plan. In operations other than war, it may be advantageous to conduct convoys during daylight hours to deny a guerrilla force the veil of darkness in which it is most effective. Establishing a timetable is critical. Supporting units use the timeline established by the commander to plan their internal operations and ensure their assets are available for timely support of the convoy.

Convoys are not standard; they vary in size and composition based on the current tactical and logistical situation. The convoy commander must plan ahead, identify a security element, (an advance and rear guard if available) establish a time to consolidate, properly brief convoy elements, and provide time for rehearsals.

A common convoy radio frequency must be established and disseminated to the entire force for several reasons:

- A convoy comprising armed wheeled and tracked vehicles may cause alarm among the predominantly dismounted forces it is passing through, especially during hours of limited visibility. By having a common convoy frequency, commanders of these forces can track the progress of the convoy and quickly communicate with the convoy commander if necessary.
- Each convoy will most likely comprise vehicles and personnel from different units. Once the convoy is constituted, the common frequency facilitates C2 until units reach the release point.

Control of fires and rules of engagement are vital in preventing fratricide as the convoy moves in friendly areas. Personnel performing local security within the convoy itself must be briefed on locations of friendly forces along the route. If contact is made with small guerrilla units, the convoy security commander must effectively control fires; he employs only fires needed to defeat the enemy while avoiding collateral damage and casualties among friendly forces and in the local area.

Landmines are a significant and constant threat to convoys. Convoys will typically encounter point-type minefield with no patterns to them, especially in operations other than war. A wide variety of mines may be found, requiring proper IPB obstacle templating, detection, removal, proofing, cleared route marking, and area clearance operations. Obviously, the light armor security force will not have the assets or capabilities to accomplish these tasks; however, certain precautions and actions are recommended:

- Study landmine recognition handbooks.
- Use authorized translators with the local populace to help identify mine locations.

- Expect constant changes in local mine emplacement techniques.
- Ideally, the lead vehicle will be able to breach any mines encountered, or should call the engineers forward to breach.
- The proofing vehicle is the first vehicle through a breached lane, and may also mark the lane concurrently. Follow in the tracks of this vehicle.
- Never pull, stack, or cut any wire (taut or slack), without first examining both ends for mine/booby trap wires.
- Institute a mine or suspicious object drill. This drill should include warning procedures, determination of type and limits, marking, reporting, avoidance/bypass, and casualty evacuation.

Figure 4-57 shows an M8 platoon providing convoy security. The lead section (#1 and #2) leads the convoy and provides flank security to the right and/or left flank (based on METT-T). The flank security M8 (#2) maintains a position approximately one-third of the way back from the head of the column. The trail section (#3 and #4) provides rear security and flank security on the opposite side of the lead section. M8 #3 is positioned approximately two-thirds back from the head of the column. M8s #2 and #3 react to contact by the lead or trail M8s, respectively, and support each other when contact is made on either flank. M8s #1 and #4 continue to move the column through the area. The security commander is the platoon leader; he positions himself where he can best control the platoon. The convoy commander identifies vehicles to allow space for #2 and #3 to maneuver (in this case, vehicles #8 and #9). This keeps the convoy moving and allows #2 and #3 to suppress or destroy any resistance.

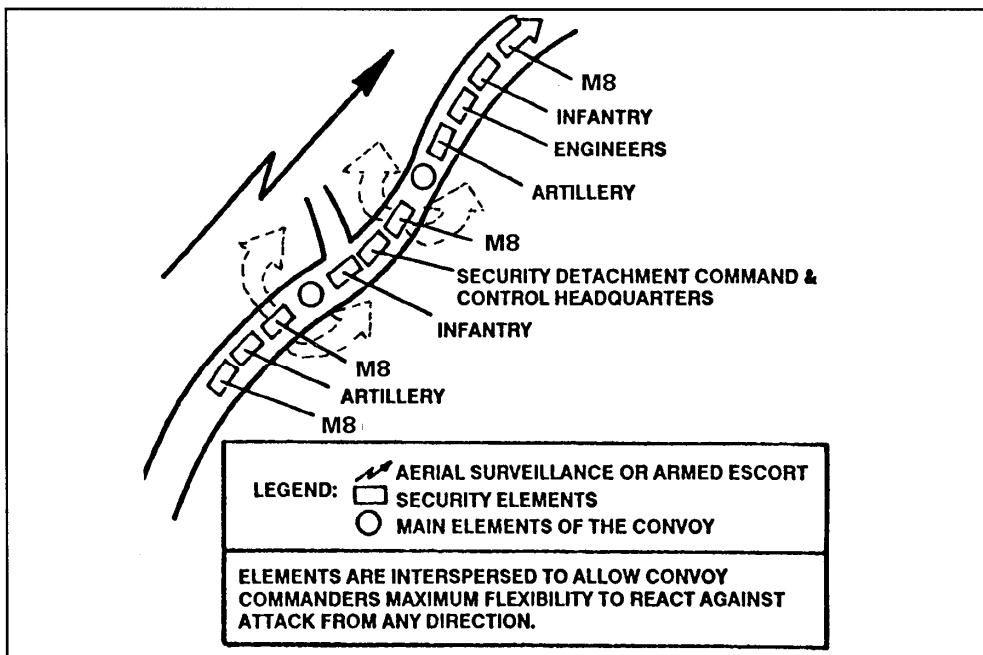

Figure 4-57. M8 platoon escorting a convoy.

## PASSAGE OF LINES

In a passage of lines, one unit moves through another unit that is stationary and disposed in a tactical formation on a forward edge of battle area (FEBA). This mission may also occur when an exploiting force moves through a force that conducted the, initial attack. Movement in forward areas must be controlled, coordinated, and kept to a minimum to avoid conflict with friendly troops. Light forces must treat the positions of forward units as danger areas that are under enemy surveillance in all weather or visibility conditions. Detailed reconnaissance and coordination are crucial to ensure that the passage is conducted quickly and smoothly.

The light armor platoon is particularly vulnerable during a passage of lines. Personnel and units may be overly concentrated; fires of the stationary unit may be masked temporarily; and the disposition of the passing unit may not allow an effective reaction to enemy forces.

The light armor platoon normally conducts the passage as part of a larger force such as a light armor company or light infantry battalion TF. The parent unit headquarters is responsible for the coordination of the passage. The higher commander provides the M8 platoon leader with the necessary details.

The commander of the passing unit makes a tentative plan for the conduct of the overall operation. The plan includes the following:

- Organization. Unit and team integrity is maintained to provide better C2.
- Order of movement. This is prescribed based on the number of passage points (PP), degree of security required, enemy situation, terrain, and the formation the unit will be traveling in after the passage. An order of movement reduces confusion and congestion by setting priorities on who moves and when.
- Security. The light armor platoon can assist in the passage of lines by overmatching to provide early warning and limited protection. It must enforce noise, light, and radio discipline.
- C2. The technique of C2 depends on the number of PPs. Ideally, multiple PPs will be established. The unit commander must decide how he can influence the action by positioning the M8 platoon. For example, if the battalion is conducting a passage of lines to attack forward of the FEBA, the M8s will probably follow the lead unit.

Control measures that can be incorporated into a passage of lines include the following:

- Assembly areas. These are areas in which a force prepares or regroups for further action. They are selected so as not to interfere with friendly forward positions.
- Attack position. This is the last position an attacking force may occupy before crossing the LD.
- Passage lanes. These are lanes along which a passing unit moves to avoid stationary units and obstacles. Planning should provide for primary and alternate lanes.
- PP. This is the point where units will pass through one another, either in an advance or a withdrawal. It is located where the commander wants subordinate units to physically execute a passage of lines.
- Time of passage. The specific time may be set by the commander ordering the passage.

- Recognition signals. These are used to send messages. Signals may consist of one or more letters, words, visual displays, characters, signal flags, or special sounds with prearranged meaning whereby individuals and units can be identified.
- Contact point. This is the point on the terrain at which two or more units are required to make physical contact.
- RP. This is a clearly defined control point on a route where specified units revert to the control of their respective commanders. Each of these elements continues its movement toward its own destination.
- Route. This is the line of travel from a specific point of origin to a specific destination.

FS planning is an essential element for a successful passage of lines. M8 direct fires of the stationary unit are normally integrated into the FS plan of the passing unit. Assets and control means may be collocated to provide coordinated and responsive support.

At a prearranged time, movement toward passage lanes begins. To increase speed and reduce vulnerability, multiple lanes are used consistent with the passing unit's scheme of maneuver, available routes, and needs of the stationary force. Marches are carefully calculated so that units arrive at passage lanes at the correct time with as few halts as possible en route. At a location short of the PP, the recognition signal is identified, and a guide links up with the passing unit. The guide taking the passing unit through the PP leads it through friendly obstacles to an RP.

The passing unit representative who conducted the last-minute coordination may position himself at the passage point to identify vehicles and troops as they move through the passage point. If necessary, challenges are made to ascertain whether units know the correct password. Command groups of both units may be collocated at a point from which they can observe critical areas, make timely decisions, and issue instructions to ensure the uninterrupted movement of subordinate units.

During rearward passages, the danger of being fired on by friendly forces makes the coordination of recognition signals critical. The stationary unit should be informed when the passing unit is just beyond direct fire range. This is normally accomplished by radio or other approved recognition signal. Once the stationary unit acknowledges the recognition signal, the passing unit moves to the PP. M8 commanders must remember to orient gun tubes toward the enemy. During the passage, stationary units must exercise particular caution in identifying enemy vehicles before engaging them.

### LINKUP

The light armor platoon may, as part of a larger force, participate in linkup to reinforce air assault forces, conduct a relief in place, move to join another force in a counterattack, or move to friendly lines after a breakout. The initial phase of a linkup is a movement to contact. As the linkup forces come close together, they are subject to coordination, control, and restrictions.

Recognition signals and a restrictive fire line (RFL) are established to prevent friendly troops from exchanging fire. Signals may include pyrotechnics, arm bands, vehicle markings, panels, colored smoke, lights, or challenge and passwords. Forces engaged by direct-fire weapons from the other side of an RFL should not return fire. Instead, they should seek cover, use smoke to conceal their actions, and notify higher headquarters. The headquarters then contacts the other unit to determine if the fires are from enemy or friendly forces. Linkup forces cannot fire across the RFL until the other unit has given permission.

## BREAKOUT FROM ENCIRCLEMENT

Encirclement occurs when the enemy blocks a unit's ground routes of evacuation, resupply, and reinforcement. This does not necessarily mean the unit is blocked by enemy forces in strength. The enemy may not be aware of the encircled unit. The unit should attack to break out as soon as possible. A delay might allow the enemy to reinforce his blocking units or to take action against the encircled unit.

The light armor platoon participates in a breakout either in the attack to rupture an enemy encirclement or as the security force conducting a defense or delay. The considerations for these operations at platoon level are the same as for a hasty attack and a hasty occupation of a BP. Logistics, however, play a key role. Equipment and supplies that cannot be carried or towed must be destroyed.

There will be situations where forces become encircled because of the mobility of enemy forces, however unsophisticated, and the nonlinear nature of battle in operations other than war. Light infantry battalions may be cut off from friendly forces either by design or because of rapidly changing situations. The battalion faces encirclement when defending strongpoints, retaining key terrain, conducting attacks, or holding the shoulder of friendly or enemy penetrations. M8s face encirclement most often when enemy forces bypass defending forces or when advancing friendly forces are cut off as a result of an enemy counterattack.

The most important consideration for encircled forces is the continuation of their mission for as long as possible. In rare cases, forces may accept encirclement to continue supporting the commander's concept of operations. The encircled force commander attempts to establish communications with his higher commander. In the absence of communications, the encircled commander acts on his own initiative to achieve the commander's desired outcome.

Encircled forces may elect or be assigned the mission to stay in position and defend themselves while they are encircled. The decision to stay and fight is based on whether—

- The available terrain provides defensive cover and concealment and is restrictive in nature.
- The encircled force can receive reinforcement or relief before the enemy can eliminate it.
- The encircled force has or can get the necessary CS to sustain its operation.
- The mission directs the unit to stay and fight.
- The mobility differential of the enemy and friendly forces is such that the encircled force could be destroyed while moving.

The senior maneuver commander within the encirclement assumes control of all forces. He informs his superior of the situation and immediately begins to—

- Reestablish a chain of command.
- Establish the best possible defense.
- Establish a reserve.
- Organize all available FS.
- Reorganize logistics.
- Establish security.
- Reestablish communications if they were interrupted.
- Maintain morale.



Encircled forces have two offensive options—a breakout attack or an exfiltration toward friendly forces. The attack to break out of an encirclement differs from other attacks only in that a simultaneous defense in other areas of the perimeter must be maintained. To achieve a breakout, the commander must accomplish the following tasks:

- Deceive the enemy as to time and place of the breakout attack.
- Exploit gaps or weaknesses in the encircling force.
- Exploit darkness and limited visibility.
- Organize the force for the breakout using the four functional forces: rupture, reserve, main body, and security force.
- Concentrate combat power at the breakout.
- Use FS to create the gap.
- Coordinate with supporting attacks.
- Follow the commander's guidance for wounded personnel.

## **RELIEF IN PLACE**

A relief in place operation, in which one unit replaces another in a combat situation, may be accomplished during offensive or defensive operations, preferably during periods of limited visibility. The primary purpose for a relief in place is to maintain the combat effectiveness of committed elements. It may be conducted to—

- Replace a combat-ineffective force.
- Replace a unit that has received a change of mission.
- Relieve a unit that has conducted prolonged operations and requires rest and reconstitution.
- Replace a unit that requires medical treatment or decontamination as a result of exposure to NBC munitions.

Relief in place requires extensive planning. Security, secrecy, and speed are critical. Incoming and outgoing commanders must coordinate—

- Exchange of liaison personnel down to company level.
- Joint reconnaissance of the AO.
- A deception plan to support the relief.
- CS and CSS from units being relieved until the relieving units are prepared to support the operation.
- Positions of weapons.
- Exchange of sketch cards and tactical fire plans and relief of organic FSE.
- Locations of and transfer of responsibility for obstacles.
- Guides and routes into and out of positions to facilitate a speedy relief.
- Transfer to the incoming unit of excess ammunition; wire lines; petroleum, oils, and lubricants (POL); and other material.
- Communications.

- Enemy situation and intelligence.
- Sequence of relief.
- Time of change of responsibility for the area.

The tactical situation dictates whether the relief will be conducted during the day or at night. Before the relief operation, the incoming unit moves to a preplanned assembly area behind the unit to be relieved. The incoming command group sets up close to the outgoing CP.

Units conduct the relief of forward positions using one of the following techniques:

- The relieving platoons occupy hide positions and move into the primary positions after the relieved elements begin to withdraw to subsequent positions.
- The relieving platoons occupy alternate positions as the relieved units withdraw from primary positions. This relief procedure is initiated when speed is desired.
- During periods of limited visibility, relieving platoons move into primary positions before the relieved platoons withdraw. Once primary positions have been occupied, the relieved platoons withdraw.

During the relief, both units are on the relieved unit's radio net. The outgoing unit maintains its previous level of radio traffic. The incoming unit maintains radio listening silence. When relief is complete, the incoming unit switches to its assigned frequency.

**LIGHT ARMOR COMPANY**

The light armor company is subordinate to the light armor battalion, but it has the flexibility to task organize to a light infantry brigade. When the company is employed with its parent battalion, its basic employment is similar to that of the tank company as described in FM 71-1. This chapter describes employment of the light armor company when it operates with a light infantry brigade.

CONTENTS		Page
Section I. Organization . . . . .		5-2
Light Armor Company . . . . .		5-2
The Light Brigade . . . . .		5-3
Augmentation . . . . .		5-3
Section II. Employment . . . . .		5-4
Missions. . . . .		5-5
Operational Planning Considerations . . . . .		5-6
Section III. Command, Control, and Communications. . . . .		5-8
Company Command and Control . . . . .		5-8
Communications. . . . .		5-9
Formations . . . . .		5-10
Section IV. Offensive Operations. . . . .		5-14
Movement Techniques . . . . .		5-14
Movement To Contact . . . . .		5-15
Hasty Attack . . . . .		5-17
Deliberate Attack . . . . .		5-18
Exploitation . . . . .		5-20
Pursuit . . . . .		5-20
Offensive Operations in Built-Up Areas. . . . .		5-20
Other Offensive Tasks . . . . .		5-22
Limited Visibility . . . . .		5-24
Section V. Defensive Operations.. . . .		5-24
Company Defensive Fire Planning. . . . .		5-26
Defense of a Battle Position . . . . .		5-27
Defend in Sector . . . . .		5-27
Defense of a Strongpoint . . . . .		5-28
Perimeter Defense . . . . .		5-29
Light Infantry Antiarmor Defense . . . . .		5-30

CONTENTS (Cont)	
	Page
Defending Built-Up Areas . . . . .	5-31
Other Defensive Tasks . . . . .	5-32
Limited Visibility . . . . .	5-34
Section VI. Other Operations . . . . .	5-34
Lodgements . . . . .	5-34
Retrograde Operations . . . . .	5-34
Convoy Security . . . . .	5-37

## Section I. Organization

### LIGHT ARMOR COMPANY

The light armor company's combat vehicles consist of 14 M8s. The company is organized into three platoons of four M8s each and a company headquarters consisting of two M8s. See Figure 5-1 for a diagram of company organization.

The task organization of a light armor company to a light infantry brigade is the norm. The brigade commander has the option to employ the light armor company as a separate combat element, or further task organize light armor platoons to infantry battalions.

This subsection will cover the employment of the light armor company as a company or team operating with its parent light armor battalion or task organized to the light infantry brigade as a single combat element. The light armor company can be organized as follows:

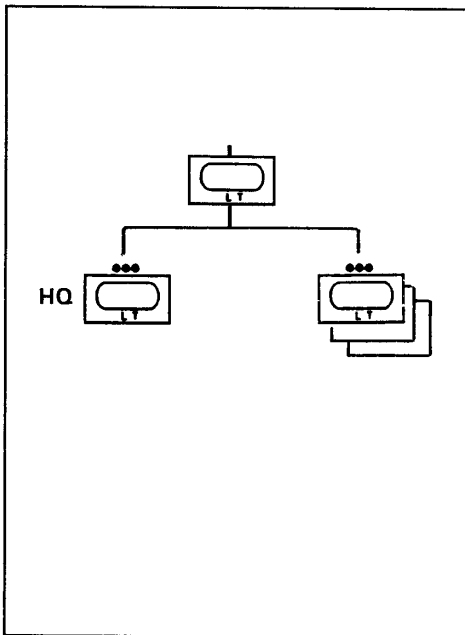

Figure 5-1. The light armor company.

- As a company or team under OPCON to a light infantry battalion,
  - or under brigade control,
  - or under light armor battalion control.
- Partially task organized (one or two platoons) to battalions with the company headquarters and remaining platoon(s) retained at brigade control or task organized to a battalion.
- Providing platoons to each of the three light infantry battalions. The company commander may go to the battalion with the most critical mission. He can receive attachment of infantry and/or TOW platoons along with the light armor platoon to form a team organization.

## THE LIGHT BRIGADE

The tables of organization and equipment (TOE) of the brigade headquarters varies by type of light force. While all brigade headquarters serve to provide C2 and supervision of tactical operations, different brigade organizations have varying degrees of capabilities and limitations. The structure and capabilities of the parent light division also affect the integration of a light armor company into a light infantry brigade. The light armor company commander attached to a light infantry brigade must understand what the brigade is capable of in terms of service and support. Consider the following points regarding different types of brigades:

- Light infantry brigades. Light infantry brigades are the most austere headquarters in terms of communications ability and number of staff officers. There is no assistant S3-Air or LO and there are fewer vehicles in the main CP. All organizational maintenance is centralized at the brigade maintenance section. All Class I is prepared by the brigade mess team. The LID and brigade depend on corps transportation. One notable characteristic of light infantry is the limited antiarmor capability of the brigade; there are 12 TOWs and 54 Dragons per brigade.
- Airborne brigades. Once opposed entry operations are complete, airborne brigades operate as light infantry, but with a greater capacity in terms of CS and CSS than a light infantry brigade. There are 60 TOWs and 54 Dragons per airborne brigade. However, the airborne division has only one attack helicopter battalion, as does the light division.
- Air assault brigades. Air assault brigades most closely mirror armor and mechanized brigades in terms of staff composition and the robustness of the CSS system. Although the number and distribution of high-power radios are the same as in the light infantry brigade, the air assault brigade frequently uses its attached helicopters as one means of extending its C2 capabilities. These brigades have habitual relationships and attachment with an assault helicopter battalion, which provides lift for the brigade. Air assault units are not tied to secure ground lines of communication for logistics as are other units. Antiarmor capabilities are the same as in the airborne brigade. In addition, the air assault division has a combat aviation brigade consisting of two attack helicopter battalions, giving it a greater divisional antitank capability.

## AUGMENTATION

The CSS capability of both light armor and light infantry forces begins to degrade after one to three days. Light infantry units have difficulty operating with light armor units because the logistics support structure of light infantry is generally austere. Light armor forces operating with light infantry forces for more than three days require more detailed CSS planning and augmentation at all levels.

Attachment requires the light infantry brigade to operate with the light armor company. To do this, the light infantry brigade must receive attachments of light armor battalion CSS assets or support from the LID or corps. These should include Classes III and V, transportation assets, and light armor maintenance assets.

Normally, the light armor company will come with CS and CSS assets. Much of this support can be standardized with the final determination based on the tactical situation.

<b>Augmentation Support</b>	
<b>Possible Augmentation:</b>	<b>Provided by:</b>
FIST	Bale's DS Arty Bn or DIVARTY
Engineer platoon	Corps or division engineer
MEDEVAC team (HMMWV)	Light armor battalion
Maintenance team (see Chapter 8)	Light armor battalion
Ammo section (two 5-ton trucks as a minimum)	Light armor battalion
Fuel section (two 5-ton trucks)	Light armor battalion
DS maintenance contact team	DS maintenance battalion
automotive, armament, commo mechanics with limited ASL	

Integrity of the light armor company may be maintained to achieve mass, to facilitate C2, and to provide CSS. In some situations, however, it will be necessary to attach light armor platoons to light battalions. It will be prudent under most circumstances to maintain a light armor reserve at brigade level.

## Section II. Employment

The light infantry brigade commander will establish the role and position of the light armor company based on the factors of METT-T and the current situation. The use of the light armor company can vary based on the commander's estimate of the situation. The light armor company may be employed as a maneuver, overwatch fire, or reserve force.

As a maneuver element, the company team is normally given the mission of seizing an objective. The objective may be undefended or occupied by an enemy force. The light armor company should lead the attack against automatic weapons, antipersonnel mines, wire entanglements, and enemy light armor or motorized forces. Light armor and infantry can move together in the assault against entrenched infantry, jungle positions, heavily fortified areas, towns and villages, and during periods of low visibility.

The light armor company (or portions of the company) can provide overwatch or direct fires for the light infantry maneuver or assault. The brigade or battalion (if task organized to battalion level) gives the company a support by fire or overwatch position for this mission. The company observes the enemy and provides information to the maneuver element. It places destructive or suppressive fires on known and suspected enemy positions, adjusts indirect fires to support the maneuver force, protects the maneuver force against counterattacks, and provides other assistance. Light armor overmatches and supports by fire while light infantry assaults—

- Against constructed antitank defenses such as ditches, abatises, and minefield.
- Through heavy woods.
- Within cities, villages, and towns.
- In mountainous terrain.
- When the terrain is extremely restrictive along the approach axis to the objective.
- When fields of fire and observation are adequate for long-range main gun and machine gun fires.
- When enemy tanks on the objective must be suppressed and the only armor approach is frontal.

The company may be designated as the brigade reserve and move in depth of the brigade formation. Its general location and possible missions are normally specified by the commander based on METT-T. The commitment of this reserve is the most critical decision of the brigade commander. The reserve may be assigned one or more of the following missions or tasks:

- Assume the mission of the attacking unit.
- Attack from a different direction.
- Support the attacking unit by fire.
- Provide flank security against an armored threat or on armor avenues of approach.
- Protect or assist during consolidation on the objective.
- Protect key intersections and bridges.
- Block a counterattack.

## MISSIONS

Missions and tasks that the light infantry and light armor company may execute when operating with a brigade are listed in the following chart.

<b>Missions and Tasks</b>	
<b>Light Infantry Brigade</b>	<b>Light Armor Company</b>
Movement to Contact	Overwatch enemy avenues of approach; attack by fire; provide mutual supporting fire; provide direct-fire suppression on prepared positions; overwatch/assist in reducing obstacles; serve as guard, reserve, or counterattack force.
Hasty Attack	Attack by fire; conduct an assault breach; serve as reserve; conduct exploitation.
Deliberate Attack	Isolate the objective; attack by fire; provide direct fire; deceive the enemy concerning the main effort; overwatch counterattack routes; serve as reserve; conduct exploitation.
Exploitation	Lead the exploitation; overwatch; serve as reserve or security force.
Pursuit	Lead the direct-pressure force; overwatch; serve as reserve, enveloping, or security force.
Follow and Support	Provide direct FS; reduce obstacles; clear bypassed forces; secure key terrain and LOCs; provide rear area security.
Cover	Overwatch; screen; and guard.

<b>Missions and Tasks (Cont)</b>	
<b>Light Infantry Brigade</b>	<b>Light Armor Company</b>
Defend in Sector	Defend a BP; cover obstacles with long-range fires; serve as security or reserve force; deceive enemy about main defense.
Breakout from Encirclement	Serve as rupture force or rear guard.
Linkup	Serve as contact element or security, overwatch, or reserve force.
Delay	Overwatch; counterattack by fire; conduct deception; reinforce; serve as reserve, or counterattack force.
Withdrawal	Serve as DLIC, rear guard, reserve, or covering force; overwatch; fix enemy attack; conduct deception; occupy positions in depth.
Retirement	Serve as security force.

## OPERATIONAL PLANNING CONSIDERATIONS

**Intelligence.** The light infantry brigade may use the mobility and thermal sight capability of the light armor company to conduct reconnaissance and surveillance (R&S). The light armor force may also participate in security operations. Light infantry brigade R&S plans should incorporate these capabilities.

The light infantry S2 may not be aware of the IPB needs of the light armor platoon: number, armor protection level, and armor-piercing capability of enemy forces; presence of antitank jamming emitters; and terrain analysis for mobility corridors. The potential NBC threat targets are identified by the battalion chemical officer. The light armor platoon leader should request these as priority intelligence requirements (PIR) and ask the S2 to work on them.

**Maneuver.** The following considerations apply during planning:

- Light armor companies will generally fight at night since light infantry is employed at night whenever possible. Night operations increase light infantry survivability and enhance the use of stealth to gain the advantage over the enemy.
- Light infantry is best employed in close, restrictive terrain during both offensive and defensive operations. In this case, the light armor company assists the operations of the light infantry brigade. In restrictive terrain, the light armor company will be vulnerable to enemy infantry and will be dependent on light infantry for security. The company will normally be task organized by platoons in restrictive terrain.
- In more open terrain, light infantry will be vulnerable to enemy armor forces and will become more dependent on the light armor company for protection. The company will more likely be kept intact when in open terrain.
- Light armor should be careful not to leave the light infantry behind when leading attacks. Both forces will then lose the mutual support they need. Infantry may be carried on top of M8s or intacts (if available), but only before enemy contact. The survivability of infantry riding on such vehicles is at great risk if enemy contact is made while infantry is still mounted. M8s may assault enemy positions. They should not go so far that the enemy is able to recover and take countermeasures before friendly infantry arrives.



- The light infantry normally conducts an area defense to hold ground. The light infantry brigade may desire to employ light armor elements forward to assist light units in their defense. The brigade, however, should also employ a light armor reserve. This mobile reserve will be able to respond quickly to any portion of the brigade AO to eliminate enemy penetrations.
- The light armor company possesses weapons of greater range and destructive power than light infantry. Light armor weapons assist light infantry in accomplishing missions by suppressing or destroying enemy infantry and armor. This can be done from ranges that exceed the ranges of light infantry weapons. One caution is that the firing of M8 main gun APFSDS and M2 armor-piercing ammunition is dangerous to friendly infantry forward of those weapons. The ammunition contains discarding petals that could strike anyone within 1,000 meters forward and 70 meters left or right of the gun target line. The light armor company commander tracks the NBC hazards to reduce his vulnerability and risk level. Smoke is used to enhance the maneuver of the light armor company and prevent enemy observation.

**Fire Support.** Light armor forces are supported with essentially the same FS structure provided to an armor company. The FIST provides access to tactical fire direction systems (TACFIRE), light tactical fire direction systems (LTACFIRE), and follow-on digital fire support communications planning and coordination systems. The FIST also has the capability to accomplish all fire support functions using voice or manual means.

If a FIST is not available, the company commander must be prepared to integrate FS into operations. The battalion FSO/FSE will assist him in this action.

Consideration must be given to positioning the company FIST. Although the FIST is not equipped with an armored vehicle, they must be positioned where they can best maintain communications and control FS in support of the company.

All FS assets available to the force are also available to the light armor company, ranging from organic mortars and divisional field artillery in DS, to air support and NGF. Planning for and use of FS will multiply the combat power of the light armor company.

Consideration must be given to the type of forces that will follow combat by light armor forces. Submunitions from various FS assets may have residual lethality particularly for light infantry forces.

**Mobility and Survivability.** Light division engineers are not capable of supporting light armor units. In order of desirability, the light armor company should be tasked organized with a platoon of corps mechanized engineers, corps wheeled engineers, corps airborne engineers, or corps light engineers. The light infantry brigade has a limited capability to carry barrier materials to areas where they need to be employed. However, the rapid emplacement capability of FASCAM and Volcano can quickly shape the battlefield and slow the enemy's advance. Commanders must be aware of and deconflict the counterattack maneuver plan and the countermobility plan to ensure clear routes for the M8s. In addition to engineer operations, the light armor company commander must integrate NBC operations into his mission analysis. NBC defense measures, smoke operations, and reconnaissance operations are a vital part of a unit's ability to move and survive.

**Air Defense.** Air defense for light armor companies should be kept mobile. It must also have access to the air defense early warning net, control net, and missile resupply. This can be accomplished if the light armor company's air defense slice includes Avengers. If Stinger teams are provided, it will be difficult to put the gunner under armor. Stinger HMMWVs may be used to monitor the early warning and control nets since it will normally be employed forward. If this is not possible, the company should provide a dedicated radio so air defense personnel can monitor the early warning net.

**Combat Service Support.** Light forces conduct CSS more frequently than light armor forces, but require less materiel. The light armor company must coordinate closely with the light infantry brigade to establish procedures for CSS. Procedures include the timing of support, amounts normally needed, and types of supplies needed. Much of the light armor unit's ammunition will not be familiar to the light infantry. Special arrangements may have to be made so that spare parts for the light armor company are requested and received in a timely manner.

The light armor battalion can augment the light infantry unit's CSS assets with an appropriate slice of support vehicles and personnel to bolster the light unit's ability to properly support the light armor company. Chapter 8 discusses this augmentation in more detail.

The company supply sergeant should keep the company's field trains in the light infantry brigade's forward area support team (FAST). He should learn the locations of all supply points such as food, fuel, and ammunition. It may be necessary to coordinate with the brigade either to go to higher unit supply points to receive supplies or to receive throughput supplies from higher units. The light armor company should be prepared to assist in the resupply of light infantry units during more mobile situations.

**Command and Control.** Providing continuous liaison between the light armor company and the light infantry brigade headquarters will enhance C2. During planning and preparation, the company commander can perform this function. He is experienced in dealing with a staff and is capable of advising the commander on the employment of his company.

During operations, the light armor company normally does not have the capability to provide liaison personnel. The importance of liaison in a light infantry/light armor situation, however, will require that liaison be made. In certain locations in the light infantry brigade, radios may not have the range to communicate with the company continuously. The light armor company commander may provide the company XO with his M8s to conduct liaison with the light infantry brigade during the conduct of operations. This will serve two purposes. It will provide continuous communications and liaison between the light armor company and the light infantry brigade. It will also provide security to the light infantry brigade CP when there is a limited enemy armor threat. The light armor battalion may also deploy an S3 representative or scout platoon NCO as a liaison to avoid using a company member.

The light armor company and light infantry brigade should develop and use SOPs. The company will use the light infantry brigade's report formats. Common hand-and-arm signals must be determined for light armor and infantry units to understand each other (see Chapter 4). The company will have to learn the light brigade's procedures for conducting CSS. The brigade must determine how to meet the CSS needs of the light armor company.

The light armor company and light infantry brigade should review operational terms to ensure mutual understanding. The light armor company commander should be included in all command group meetings and in all rehearsals. These activities will provide opportunities to clear up misunderstandings, ensure the best employment of combat power, improve synchronization of operations, and reduce fratricide.

## **Section III. Command, Control, and Communications**

### **COMPANY COMMAND AND CONTROL**

The commander must be careful to select the position that allows him to be at the most critical place on the battlefield. He must use terrain and weather to conceal movements from the enemy, but he must maintain visual or radio contact with his platoons.

The company commander must synchronize actions with the other company commanders. He must quickly inform the TF commander when anything critical happens. If contact with

the TF is lost, the commander makes every attempt, without abandoning the mission, to reestablish communications. The commander continues to take actions that accomplish the commander's intent until communications are restored.

The company XO can help by monitoring the TF frequency and making reports to the TF on the tactical situation. When direct contact with one or more platoons is not possible, the XO may position where he can control those elements.

The company commander ensures that the platoon leaders maintain contact with him and keep him informed of their situation. He should encourage the platoon leaders to talk to each other and coordinate their actions. Cross-talking between the platoons on the company command net should be encouraged.

The company commander should issue clear orders. He must state the mission, intent, and any other instructions that affect movement and fire control so that they are understood. WOs must be issued early to give leaders time to react to all possible upcoming missions. Keep subordinates informed on the enemy situation and what other units in the TF are doing.

## COMMUNICATIONS

The quality of communications in the company is dependent on the individual skills of the soldiers, the equipment and the desires of the commander. Several means of communication are available. Each should complement the others so that the company does not rely on only one means. Dependence on one means of communication, such as the radio, endangers C2. Figure 5-2 shows the company communication network. The five basic means of communication are used as follows:

- Wire should be used as the primary means of communication for OPs, BPs, strong-points, combat trains, and assembly areas.
- Messengers can be dispatched when the unit occupies an assembly area or BP or reorganizes on an objective. Messengers can rehearse routes in daylight (if possible) prior to changes in visibility and carry handwritten notes to increase accuracy.
- Visual signals are used from the SOI or unit SOP. See Chapter 4 for standard hand-and-arm signals. Other visual signals include lights and flags.
- Sound signals can be used from the SOI or unit SOP. Sound signals can include pyrotechnics, metal on metal, whistles, bells, or rifle shots.

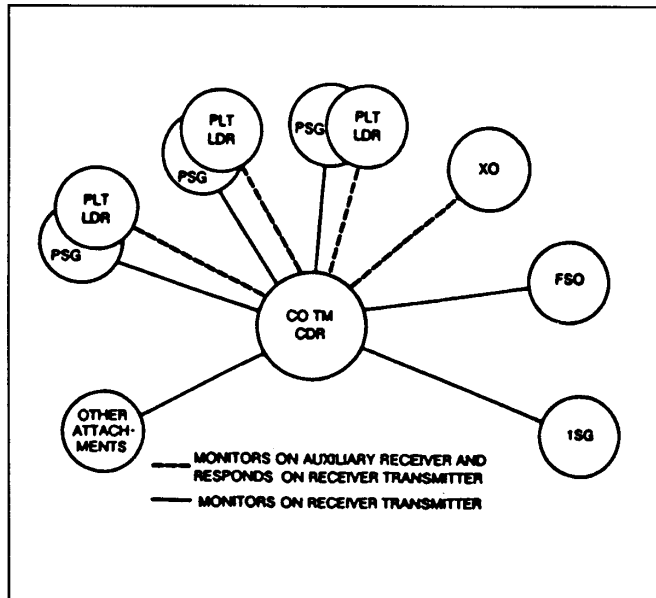

Figure 5-2. Company communication network.

- Radio is the primary means of communication when enemy contact is made. The company commander operates the company command net and monitors the TF net. The company XO operates on the TF command net and monitors the company net. If the company is task organized under brigade control, the company commander may be required to operate on the brigade command net. If this is the case, the XO can assist by operating the company net and monitoring the TF net. The 1SG operates on the TF administrative/logistics (A/L) net and monitors the company net. Platoon leaders operate on their nets and monitor the company net.

## FORMATIONS

The company commander uses formations to control movement. SOPs should standardize the company's use of reporting procedures, formations, movement, and C2 techniques. Basic battle drills and formations can be found in Chapter 4. The company has five basic formations: combat column, wedge, vee, line, and echelon. When designating the company formation, the company commander—

- Establishes the relationship of one platoon to another on the ground.
- Expresses where he envisions the enemy to be and how he intends to react to contact.
- Establishes where firepower is needed.
- Establishes how (mounted or dismounted) and where light infantry travels in relation to the vehicles.
- Establishes the degree of security desired.

A combat formation is not rigid. Terrain and common sense will frequently dictate needed changes. Unless directed, it is not necessary for the company to use the same formation as the infantry brigade or battalion.

**Column** (see Figure 5-3). this formation is used when speed is critical and the possibility of enemy contact is not likely. Light infantrymen are usually mounted on M8s or trucks (if available). A modified version, the combat column, can be used if the terrain allows for dispersion. The combat column can be used when contact is likely and speed is important. Infantryman, if M8-mounted, should not travel on the lead platoons vehicles.

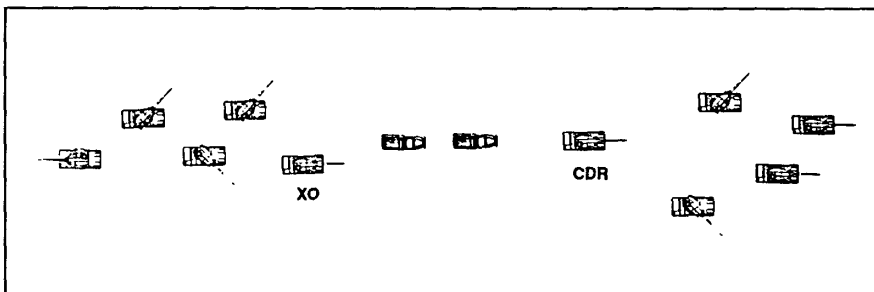

Figure 5-3. Combat column formation.

**Wedge** (see Figure 5-4). The wedge is used when the situation is vague and contact with the enemy is imminent. This formation can be used to move in relatively open terrain to provide some protection to dismounted light infantrymen. See Figure 5-5 for an example of a modified wedge formation.

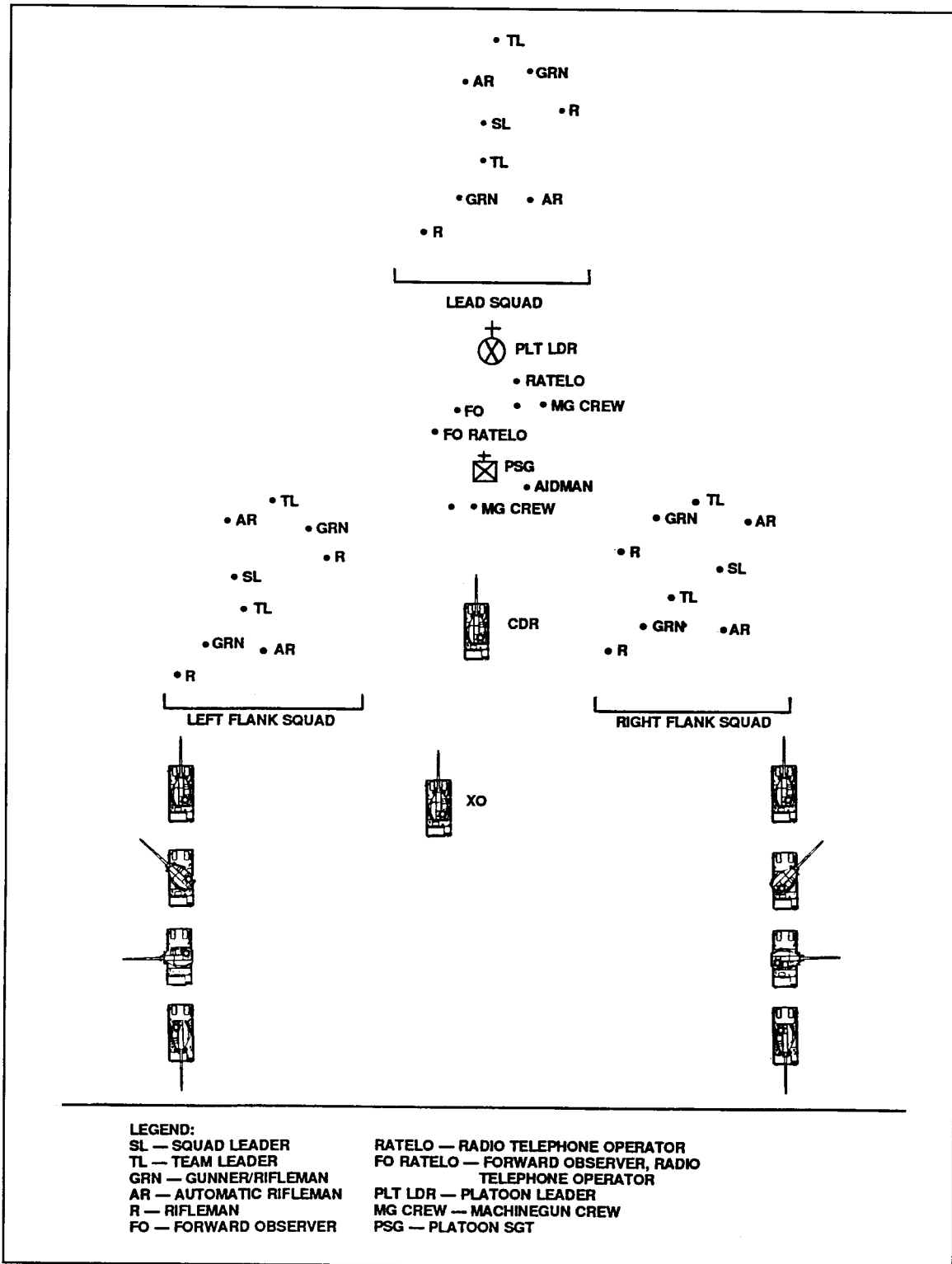

Figure 5-4. Wedge formation.

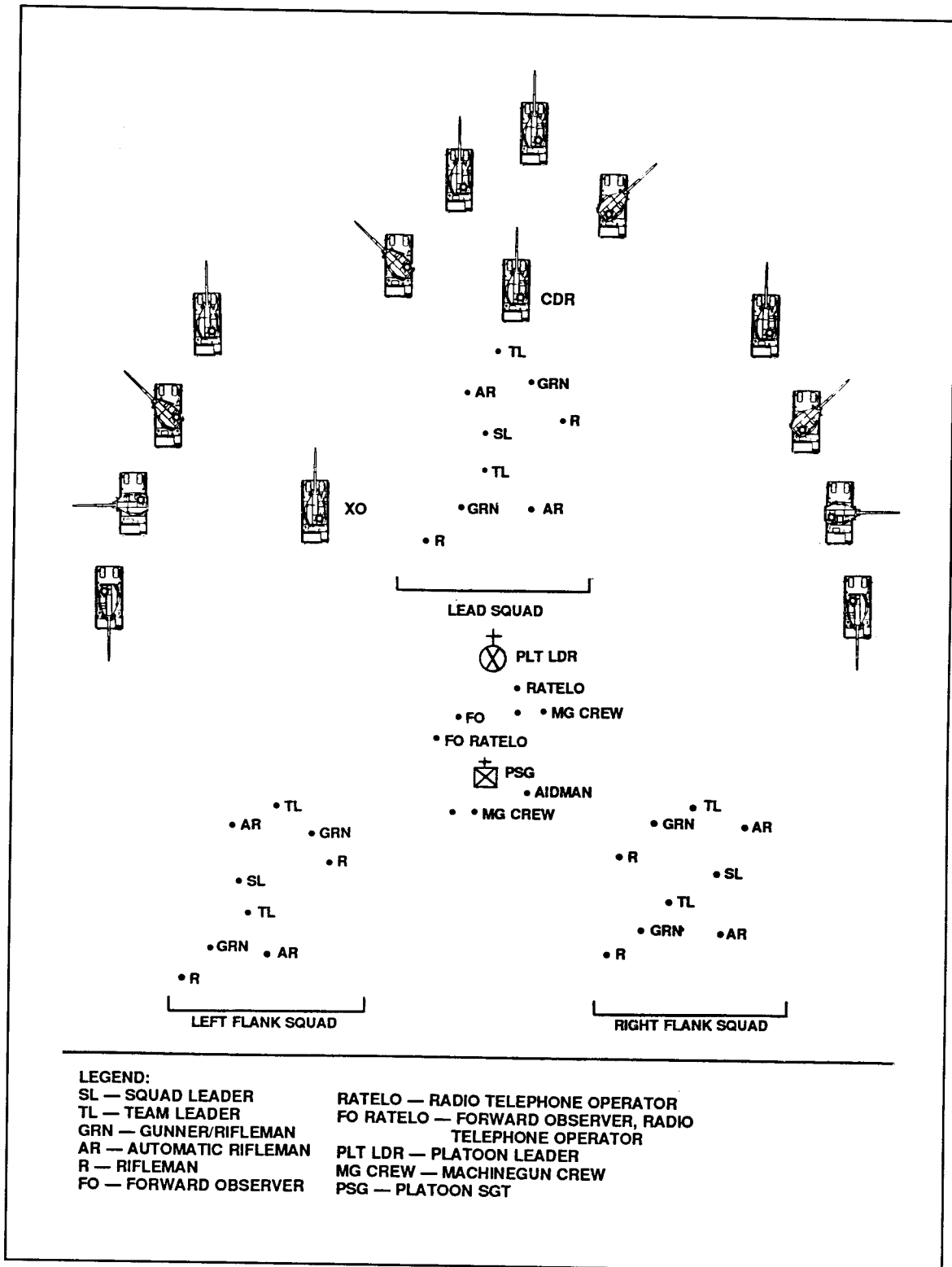

Figure 5-5. Modified wedge formation.

**Vee** (see Figure 5-6). This formation is used when probability of enemy contact is high. It provides maximum firepower up front while leaving a platoon in depth to maneuver. This is a difficult formation to use when task organized as a team of two light armor platoons and one infantry platoon.

**Line** (see Figure 5-7). This formation is normally used, if terrain permits, when assaulting an objective. It can also be used to emerge from smoke or woodlines. In this case, platoons should use overwatch or support by fire techniques to cover each other. Light infantry cannot move forward of the M8s when assaulting due to the danger of discarding-sabot ammunition.

**Echelon.** The echelon is used when one flank faces a significant threat. Usually only used when M8 pure. It is extremely difficult to use with dismounted infantry if there is contact to the opposite side of the echelon. If that happens, the M8s will not be able to conduct action drills without endangering infantrymen.

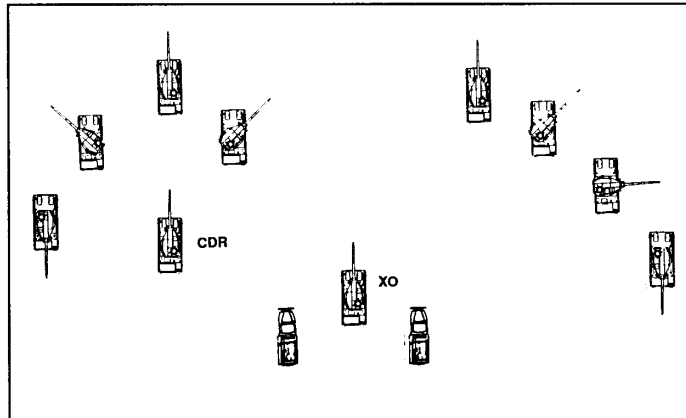

Figure 5-6. Vee formation (infantry truck mounted).

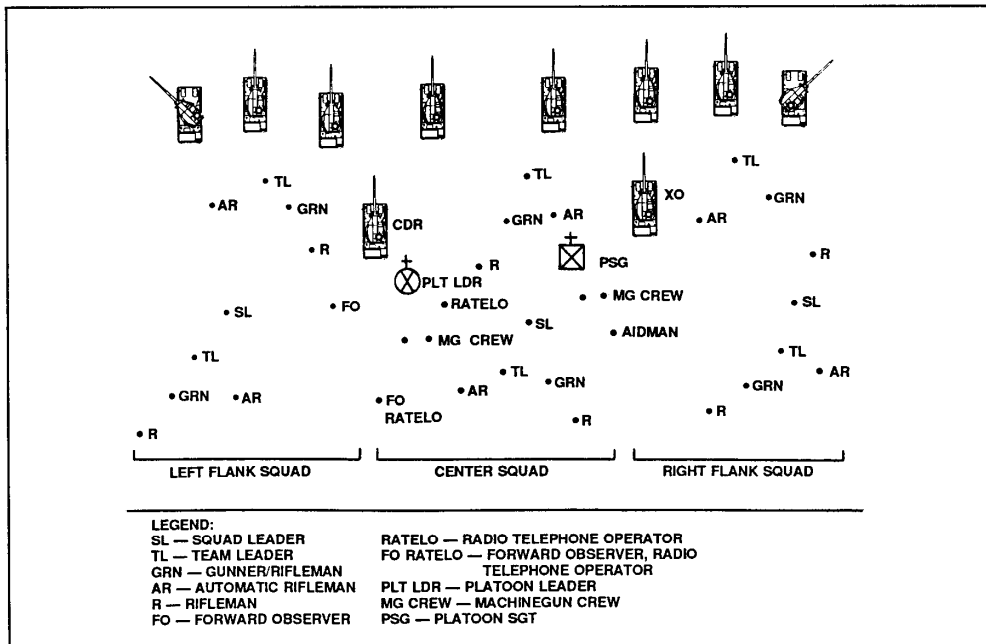

Figure 5-7. Line formation.

## Section IV. Offensive Operations

When operating with the light infantry brigade, the light armor company can be employed in one of four methods:

- As part of the main attack.
- As a reserve or follow-on in support of the main attack.
- As reconnaissance and security forces forward, on the flanks, and to the rear of the main and supporting attacks.
- As part of the supporting attack.

The light armor company participates in two types of offensive missions—movement to contact and attack (hasty and deliberate). The company may participate in an exploitation or pursuit. It will normally participate in these missions as part of a larger infantry force (brigade), but on some occasions it may operate as part of a light armor TF.

### MOVEMENT TECHNIQUES

Tactical movement techniques are used in conjunction with formations. See Chapter 4 for more information about movement techniques.

**Forms of Maneuver.** The light infantry brigade uses the same basic forms of maneuver as the light infantry battalion described in Chapter 4. For further information on the light infantry brigade, see FM 7-30.

**Avoiding Enemy Antiarmor Fire.** When the terrain allows the light armor company to maneuver in mass, it presents an easily identifiable target and is vulnerable to enemy antiarmor and tank fires. The company should use all available cover and concealment; the enemy cannot mass fires against the company if it cannot see it. Despite its obvious advantage, however, moving along covered and concealed routes costs the company in terms of speed, control, and vulnerability to short-range, handheld antiarmor weapons. Smoke is used to defeat enemy observation and target acquisition.

M8s must never skyline or move directly forward from a defilade position. Avoid dusty terrain when possible; it betrays the movement of armored vehicles. Before crossing open areas, use attached infantry or dismount personnel with binoculars to observe the area carefully for possible enemy positions prior to emerging from cover. If enemy locations are identified or suspected, suppress them or use smoke on them before crossing.

Cross open areas as quickly as possible. Use rapid rushes from one covered position to another. If an M8 is exposed for less than 30 seconds, it will be extremely difficult for an enemy ATGM gunner to acquire, fire, track, and hit it at long range. Use 15- to 20-second rushes when suspected ATGM positions are close.

In situations where use of covered routes is too time-consuming, plan for escape routes (see Figure 5-8).



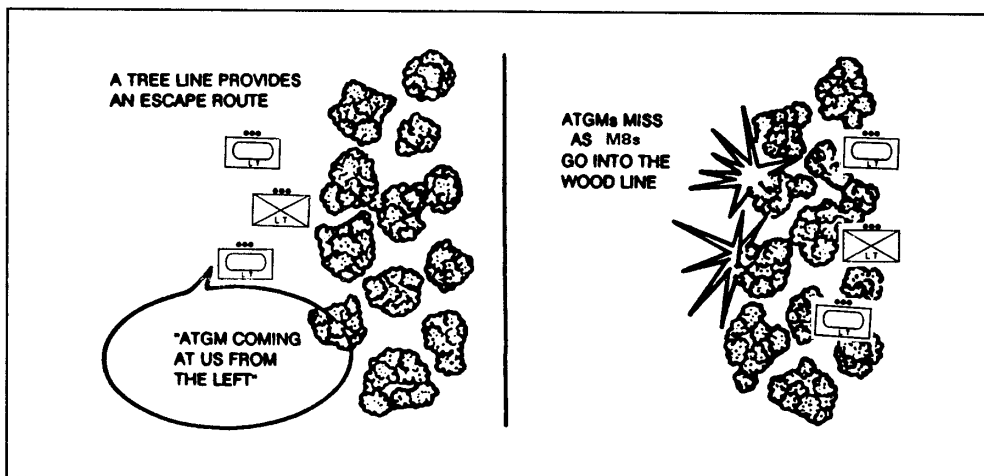

Figure 5-8. Company movement with escape routes.

## MOVEMENT TO CONTACT

A movement to contact is an offensive operation designed to gain contact with the enemy. A company can expect to task organize one or two of its platoons to infantry battalions during a movement to contact. The remaining platoon(s) will be retained under the company headquarters with infantry attached as the brigade reserve. The company commander will designate specific movement techniques and formations to reduce danger to the unit while moving. Once contact is made, the company uses fire and movement to develop the situation. In the absence of command guidance, the company commander employs the factors of METT-T to specify movement techniques and formations.

The brigade will conduct a movement to contact in two general situations. The most common situation has the brigade operating independently and attacking with one or two lead battalions (see Figure 5-9). The other situation is when the entire division is out of contact, with a great distance between friendly and enemy AOs. The brigade either moves as the main divisional body or provides units for security, guard, or security forces (see Figure 5-10). The brigade commander assesses the situation once contact is made and decides to attack, bypass, or defend based on how the situation develops.

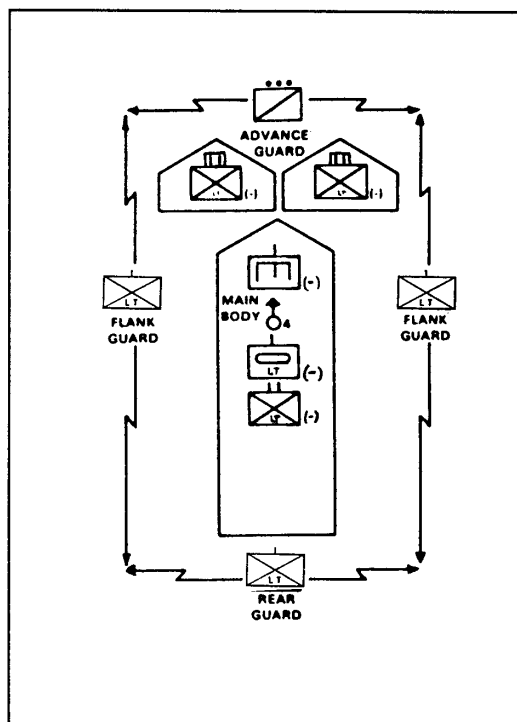

Figure 5-9. Example of a light armor company with light infantry brigade MTC: light armor company as part of a brigade vee.

In the examples illustrated in Figures 5-9 and 5-10, the light armor company has detached platoons to the lead battalion(s) and retained the remaining platoons under company control as the brigade reserve. This gives the lead battalions a small, mobile, self-contained force to locate and fix the enemy. The example in Figure 5-10 shows the light armor company retained as a unit for ease of movement. The lead battalion receives an attachment of a light armor platoon while the light armor company(-) moves with a TOW platoon as a reserve. This may be done if there is a potential enemy mechanized threat. In some cases, the light armor company can be used as forward or flank security for movement.

The example in Figure 5-11 shows the cloverleaf technique when the light armor company is given a large designated area to search rapidly.

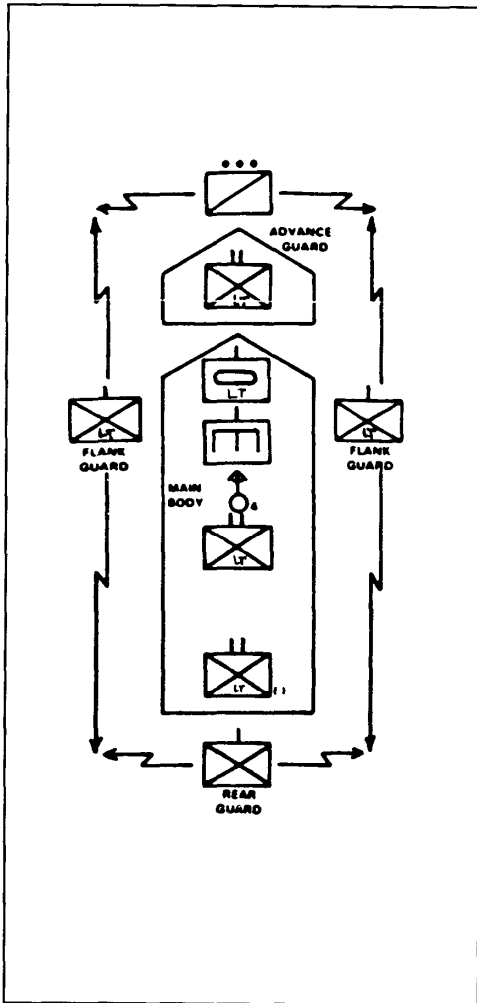

Figure 5-10. Example of a light armor company with light infantry brigade MTC: light armor company as part of a brigade column.

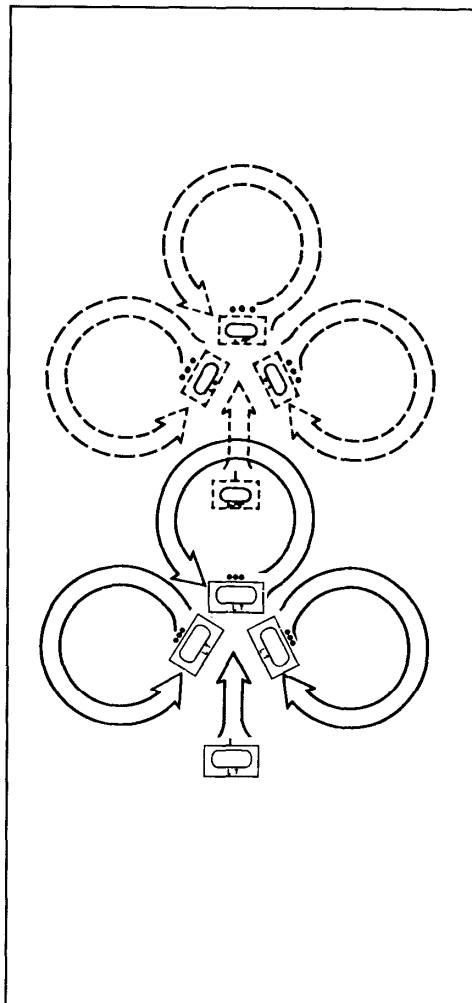

Figure 5-11. Example of cloverleaf technique.



The first infantry TF to make contact with the enemy conducts actions on contact, develops the situation, destroys the enemy if possible, and reports the situation to the brigade. The brigade commander may employ the light armor company as an assault force. Figures 5-12 through 5-14 show examples of light infantry brigade hasty attacks with a light armor company.

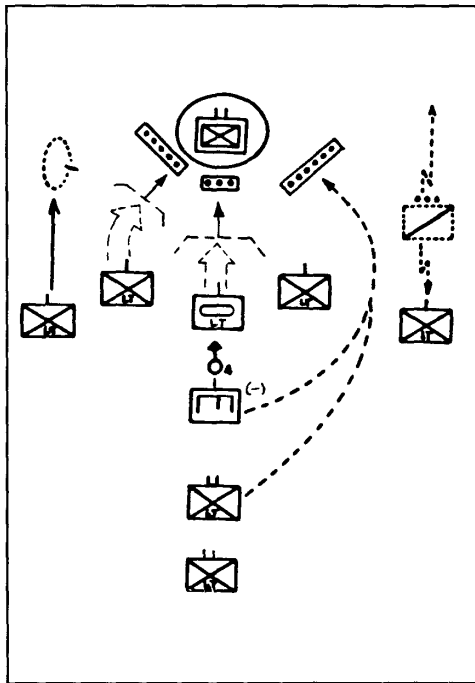

Figure 5-13. Light brigade/light armor company hasty attack, example 2.

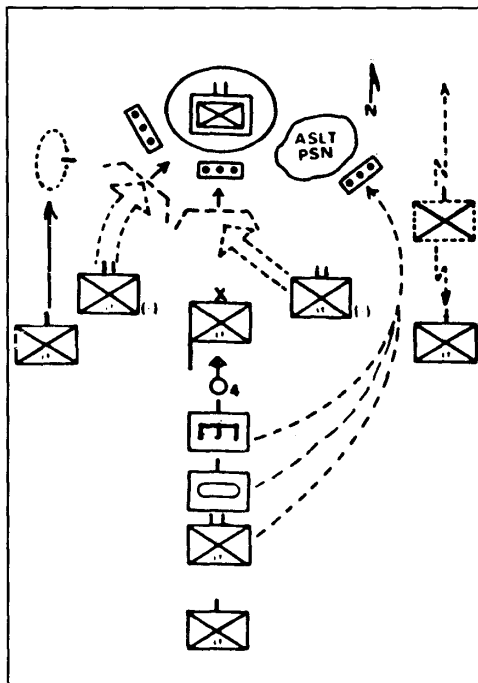

Figure 5-14. Light brigade/light armor company hasty attack, example 3.

### DELIBERATE ATTACK

A deliberate attack is usually necessary against a well-organized, well-prepared enemy that cannot be turned nor bypassed. The infantry commander will normally have time to collect detailed information about the enemy. The brigade commander may consider using the light armor company to assist in one or more of the following:

- Isolating the penetration or objective area with direct fire to prevent enemy reinforcement or supporting fires.
- Committing a strong force to overwhelm the enemy at an identified or created weak point.
- Striking the enemy on the flanks or in the rear.
- Using a form of maneuver that avoids the enemy's main strength.
- Fixing other positions to minimize the enemy's capability to react.
- Developing a deception plan.

Figures 5-15 and 5-16 show examples of a light infantry brigade deliberate attack with a light armor company.

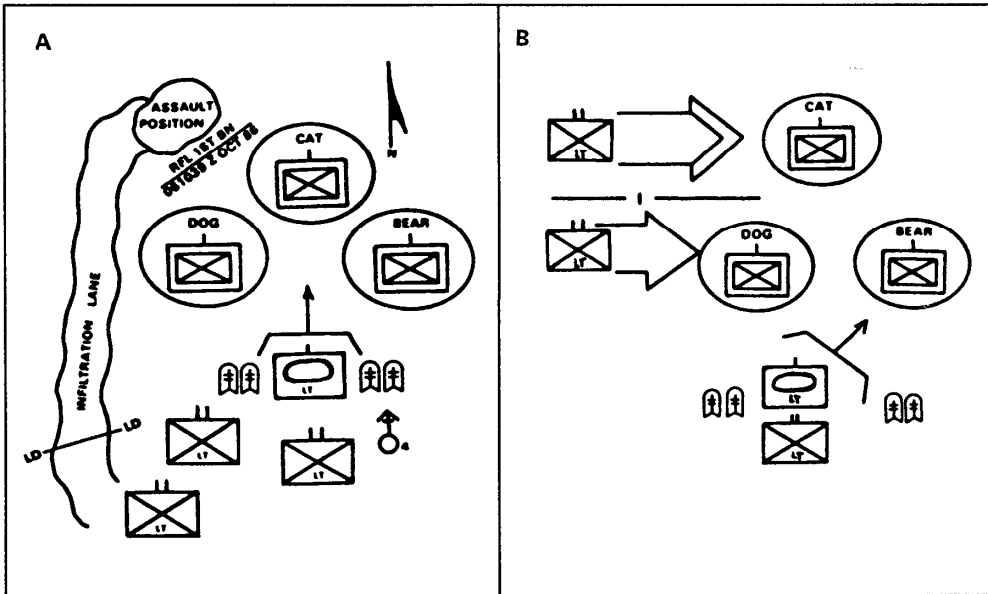

Figure 5-15. Light brigade/light armor company deliberate attack, example 1.

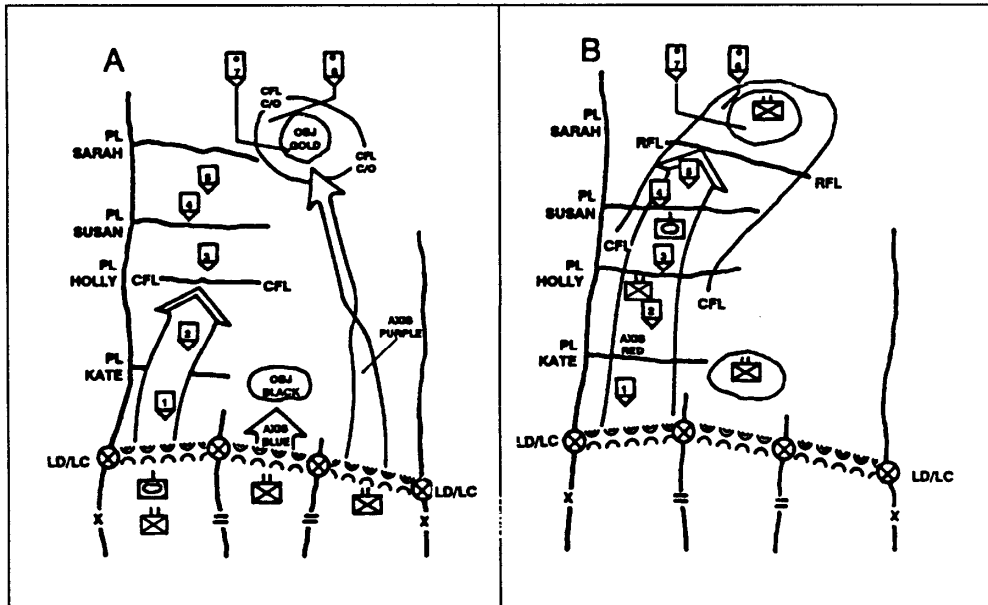

Figure 5-16. Light brigade/light armor company deliberate attack, example 2.

## EXPLOITATION

Exploitation is a continuation of an attack to take advantage of and maximize success. It prevents the enemy from reconstituting an organized defense or conducting an orderly withdrawal. It normally follows a successful attack that weakens or collapses enemy defenses. The exploitation focuses on the enemy and destroys his will to resist. Speed is essential. Mobility of the exploiting force must be equal to or greater than the enemy force.

The light armor company normally participates in the exploitation as part of a much larger force. The exploitation is executed as a movement to contact or hasty attack. Exploiting force missions include securing objectives deep in the enemy rear, cutting LOC, surrounding and destroying enemy units, denying escape routes to an encircled force, and destroying enemy reserves.

The exploiting unit advances rapidly to the enemy rear area, destroying enemy combat units and lightly defended and undefended CS and CSS activities. Bypassed enemy forces are reported to higher headquarters for reduction by follow-and-support forces. The successful exploitation can turn into a pursuit, with the end goal being total destruction of the enemy's ability to fight.

## PURSUIT

A pursuit normally follows a successful exploitation. The objective of a pursuit is to maintain pressure on the enemy and intercept, capture, or completely destroy him. Light infantry units conducting a pursuit should maximize the use of light armor assets to slow, disrupt, and confuse the enemy withdrawal. Again, the company would usually participate in a pursuit as part of a larger force in a movement to contact or hasty attack.

The pursuit is conducted using a direct pressure force, an encircling force, and a follow-and-support force. The light armor company may be part of these forces, which have the following functions:

- The direct pressure force denies enemy units the opportunity to rest, regroup, or resupply by staying in direct contact with them and forcing them to stay on the move. At every opportunity, the direct pressure force envelops, cuts off, and destroys enemy elements.
- The encircling force moves to get in the rear of the enemy and blocks his escape; in conjunction with the direct pressure force, it attacks to destroy the enemy force. It advances along routes parallel to the enemy's line of retreat to reach defiles, communication centers, bridges, and other key terrain ahead of the enemy main force.
- The follow-and-support force is not a reserve, but it is committed to destroy bypassed enemy units, relieve direct pressure force elements (which have halted to contain enemy forces), secure LOC, secure terrain, or guard prisoners at key installations.

## OFFENSIVE OPERATIONS IN BUILT-UP AREAS

Light armor units will not normally fight as a company within BUAs. However, the company may have sections or platoons task organized to infantry teams or TFs to provide direct FS for urban fighting (see Chapter 4). The phases of attacks of a BUA are also explained in Chapter 4.

The fight for urban terrain begins outside the BUA. The light armor company can be used to isolate the area and provide direct FS for the assault force to gain a foothold.

The light armor company isolates the BUA by enveloping it and seizing key terrain that dominates approach and escape routes (see Figure 5-17). The isolation serves to prevent enemy reinforcement and/or contain the enemy within the BUA. The orientation of the light armor platoons is important. Companies and platoons may be required to orient M8s toward the BUA as well as outward along mounted avenues of approach (see Figure 5-18).

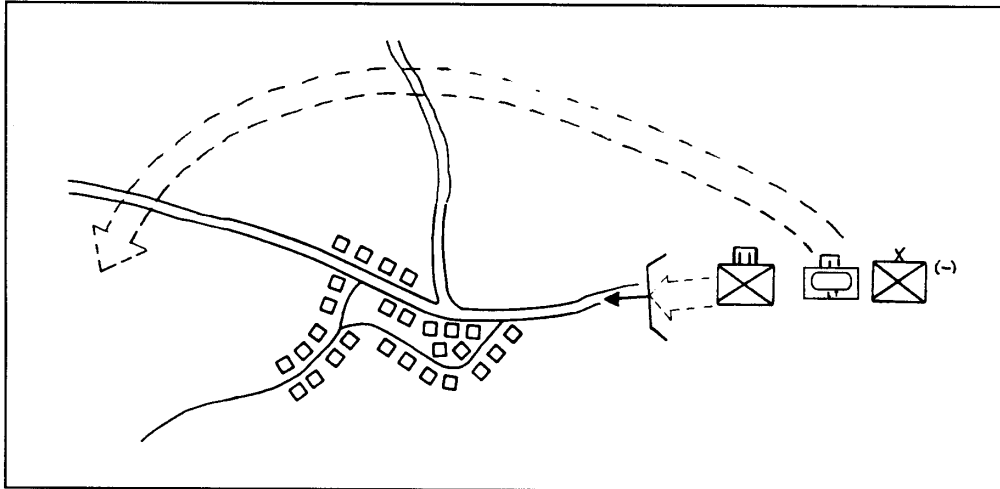

Figure 5-17. Light armor company enveloping a built-up area.

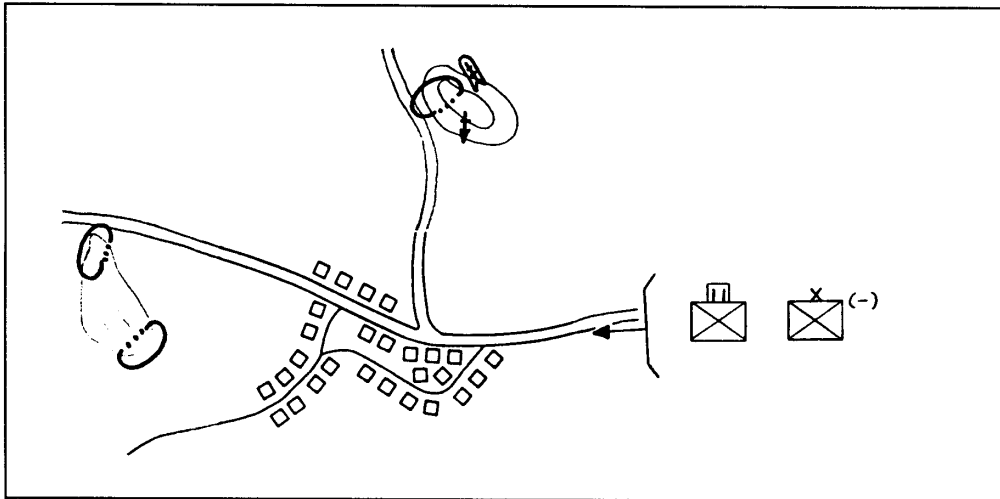

Figure 5-18. Blocking positions around a built-up area.

Light armor companies may be required to move in or through BUA when—

- There is no bypass.
- They are required to seize key positions during an exploitation or when the town is lightly or undefended.
- They are escorting a convoy through a BUA that presents little or no threat.
- There are two techniques for conducting a light armor attack in or through a BUA.

The light armor company can penetrate poorly defended or unalerted urban areas to occupy key objectives, holding them for a limited time. When the enemy defenses are weak or no organized enemy resistance is present, the lead armor unit can immediately attack. The force may not be predominantly infantry, but some infantry is required. The assaulting force drives directly to the center of the town, then proceeds to attack outward.

During exploitation, when surprise has been achieved or when tactical (or terrain) conditions make an enveloping attack difficult, it may be possible to secure the main route through the town by a sudden attack. The attack is made at top speed, with all weapons employed against any enemy personnel encountered. The move continues through the town to dominating terrain on the other side. As the attack continues, flank guards strike quickly up the side streets if necessary to protect the main body. Complete occupation of the town is left to follow-on infantry if needed. In this method, the lead M8 tank commander must be certain of his route and act boldly. If halted by antitank fire, he must notify the commander immediately to keep the following units from jamming up the streets behind him. He may request assistance, continue the assault, or reconnoiter for a bypass.

## OTHER OFFENSIVE TASKS

The following discussion describes other tactical tasks that may be required of the light armor company during offensive operations.

**Obstacle Breaching.** During offensive operations, the light armor company may be required to assist the light infantry brigade in breaching obstacles. The brigade has limited engineer support that is capable of breaching simple obstacles. The light armor company plays a key part in isolating the breach point and providing direct fire support to the breach and assault forces.

When it encounters obstacles, the infantry TF will initially reconnoiter to find a bypass. If no bypass is found and the obstacle is not complex, the TF commander may attempt an in-stride breach. If the obstacle is complex, the brigade may require augmentation from corps engineers.

The unit will be organized into support, breach, and assault forces with the following functions:

- The support force should primarily consist of M8s to provide long-range direct fire suppression of enemy defensive positions.
- The breach force consists of the engineers and equipment necessary to clear a lane through the barrier. Infantry and, in some cases, light armor will accompany the breach force to provide close-in security and supporting fires. The breach force usually operates under obscurity to protect it from enemy observation. The breach force may be required to follow and support the assault force.
- The assault force attacks to destroy enemy forces defending the obstacle. Depending on the terrain and type of defense being assaulted, it should consist of infantry and light armor.



The breach operation is executed through suppression, obscuration, security, and reduction using all available infantry, armor, engineers, artillery, and mortars. The considerations in the following paragraphs apply.

**Suppression.** The support force suppresses enemy direct fire defenses. It must put direct fires on enemy positions and adjust indirect fires and smoke from artillery and mortars.

**Obscuration.** Use of smoke or naturally obscuring terrain is a must. Special engineer equipment, engineers, and infantrymen are extremely vulnerable during the breaching phase if the enemy cannot be destroyed, suppressed, or obscured. Obscuration can also hamper C2 during the breach. Training, preparation, and rehearsals can overcome these problems.

**Security.** In some instances, light infantrymen can secure the far side of the obstacle prior to fill lane clearance through infiltration, bypass, air assault, or minor breach. Elements on the far side can help to secure the exit points of the breach lane as well as provide suppressive fire on the enemy.

**Reduction.** Reduction of the obstacle is the most complicated part of the assault breach. The support force shifts the obscuration and suppressive fires as the breaching force moves forward. Special engineer equipment that may be required includes ACEs, MICLICs, dozers, scoop loaders, and armored vehicle launched bridges (AVLBs).

**Consolidation.** Occupation of an objective is a critical task. Enemy forces on the objective must be eliminated or captured. The company must immediately prepare for a counterattack by the enemy. The company is most vulnerable and unorganized during consolidation, and the enemy will attempt to capitalize on this.

During consolidation the company commander should—

- Designate platoon positions and general orientations.
- Ensure the company occupies the position designated in the OPORD. M8s are moved to hull down positions, and the platoon leader assigns specific sectors of fire.
- Prepare for a counterattack.
- Establish security and mutual support between adjacent units.
- Eliminate any remaining pockets of enemy resistance and secure EPWs.
- Prepare to continue the mission.

**Reorganization.** Reorganization must also be conducted rapidly. Each platoon leader should report his casualties and ammunition, fuel, and vehicle status to the commander and XO. The XO or 1SG reports the status to the TF.

If the attack is to continue reorganization must be quick. The commander, XO, and 1SG should ensure that the following activities are accomplished during reorganization:

- Reassignment of crew members if losses were heavy. Survivors of damaged vehicles can replace casualties elsewhere.
- Cross-level ammunition, where necessary.
- As many repairs by the maintenance section as time allows.
- Evacuation of wounded soldiers.
- Evacuation of EPWs and intelligence information.
- Evacuation of bodies of soldiers KIA.

## LIMITED VISIBILITY

Limited visibility attacks are preferred by the light infantry. They are also the most difficult to execute. They require detailed planning, preparation, and rehearsals. Movement will be slower, confusion more likely, and consolidation and reorganization more difficult.

Control of platoons is more difficult at night in limited visibility. Strict light and noise discipline is required. Control measures are more restrictive. The following are some control considerations that apply during company planning for limited visibility operations:

- Assembly areas may be smaller and closer to the LD. Standardize platoon/company movement into and out of assembly areas.
- Guides may be posted to assist movement to the LD and through the points of departure.
- Allow more time for movement and positioning of key weapon systems.
- Objectives and routes must be more clearly defined.
- Intermediate objectives may be necessary to maintain control and direction.
- Graphic control measures are usually more restrictive. For example, restrictive fire lines (RFLs), no-fire lines, and limits of advance (LOA) may be introduced to further control unit movement and fires.
- Illumination rounds timed to burn on the ground can mark objectives and keep the company oriented.
- Navigational aids and positioning systems greatly aid in unit movement.
- Thermal night vision capability gives the M8 the ability to see farther than the passive sights of the infantry.

One of the greatest dangers to a night attack comes from the risk of friendly fire. Some techniques to help reduce the risk of fratricide include—

- Improving gunner vehicle identification and thermal image identification skills.
- Coordinating laterally before and during the battle. Knowing where units on the left and right will be, as well as their formations and their exact routes. During movement, everyone must be informed of relative locations and any route changes or delays.
- Ensuring that subordinate leaders understand all aspects of the operation. Rehearse the plan over similar terrain, at night if possible. Conduct briefbacks with each key leader (including attachments).
- Tightening control measures, especially when units are to the front or in a known direction. Use weapons hold or weapons tight status (for example, weapons hold left).

## Section V. Defensive Operations

This section describes the most common defensive missions conducted by the light armor company while operating with a light infantry brigade. Organized as a company team, the light armor company can conduct defensive combat operations—

- With its parent light armor battalion (see Chapter 6).
- Task organized to a light infantry brigade.
- Task organized to a light infantry battalion.

The light infantry conducts the following two forms of defenses:

- **Mobile defense.** The mobile defense uses a combination of offensive, defensive, and delaying actions. Brigades usually participate in mobile defenses when defending as part of a larger force. This type of defense requires mobility equal to or greater than that of the enemy; therefore, light infantry brigades use this form of defense when terrain is restrictive. All or a majority of the light armor company is kept as a reserve force during mobile defenses.
- **Area defense.** The area defense denies enemy access to specific terrain for a specific time. The bulk of the defending force is deployed to retain ground. The brigade uses a combination of defensive positions and small mobile reserves. Area defenses are usually used when depth is not possible. In that case, the light armor company usually has its platoons task organized to the infantry battalions. At least one of the platoons should be kept as the brigade reserve.

The light armor company can expect to perform one of many different missions as part of the overall brigade defensive plan. These missions can be as part of the security force or as main battle area, reserve force, or rear area actions. When planning for the use of light armor in the defense, the infantry commander should consider the following:

- **Mission.**
- **Enemy.** Light armor should be placed in defensive positions that capitalize on its long-range firepower and mobility advantages. Light armor may have to be concentrated when an enemy mounted threat exists. The company may have platoon(s) task organized to infantry battalions when a dismounted enemy threat exists.
- **Terrain.** Terrain affects three aspects of M8 positioning:
  - Protection (cover and concealment).
  - Firepower (observations and fields of fire).
  - Mobility (obstacles and avenues of approach).
  - Light armor should be massed when the terrain allows. In rolling, open terrain, the light armor company can defend in platoon BPs to overwatch mounted avenues of approach. In close terrain, further task organization of platoons to light infantry battalions may be necessary.
- **Troops available.** Employment of the light armor company may depend on the ability to provide infantry for security. When positioned in or moving through restrictive terrain, infantry is needed to assist in close security. Engineers are needed to prepare M8 fighting positions; employment and task organization may be dependent on the availability of engineer support for preparation of positions.
- **Time available.** Static defensive preparations for light armor are time-consuming. The time available may drive the decision to place light armor in BPs or in reserve.

Other planning considerations include the following:

- Determine where to kill the enemy.
- Determine positions for the M8s.
- Plan for security and limited visibility.
- Assign missions and graphic control measures.
- Determine the sequence and timing of fire and maneuver.
- Plan improvement of positions and routes.
- Incorporate a deception plan.
- Conduct lateral and higher headquarters coordination.

## COMPANY DEFENSIVE FIRE PLANNING

The company defensive fire plan enables the company commander to distribute and control fires in support of the brigade commander's defensive concept. In turn, it assists the brigade commander in preparing his fire plan. If part of the brigade area is threatened, the commander can use the fire plan to determine which weapons can cover the threatened area. Using radio or SOP signals, he can then direct fires to destroy the threat. To develop a defensive fire plan, the commander must—

- Assign a location for vehicles and sectors of fire. A sector of fire is the area where an M8 has primary responsibility for acquiring and engaging the enemy. The sectors of fire should overlap between individual vehicles and with adjacent elements on the company's flanks, based on where he wants to kill the enemy.
- Designate limited visibility capable TRPs and indirect fire targets in the company sector. The FSO assigns numbers to the indirect fire targets.
- Coordinate with adjacent units.
- Evaluate information from his vehicle commanders to determine if they can effectively observe and engage targets and TRPs within their sectors. Each vehicle commander prepares a sketch card for each position. The platoon leader consolidates them, prepares his platoon sector sketch, and gives a copy to the commander.
- Develop a sketch of the company's sector, with a list of direct fire engagements and a legend, for all primary, alternate-and supplementary firing positions (see figure 5-19).

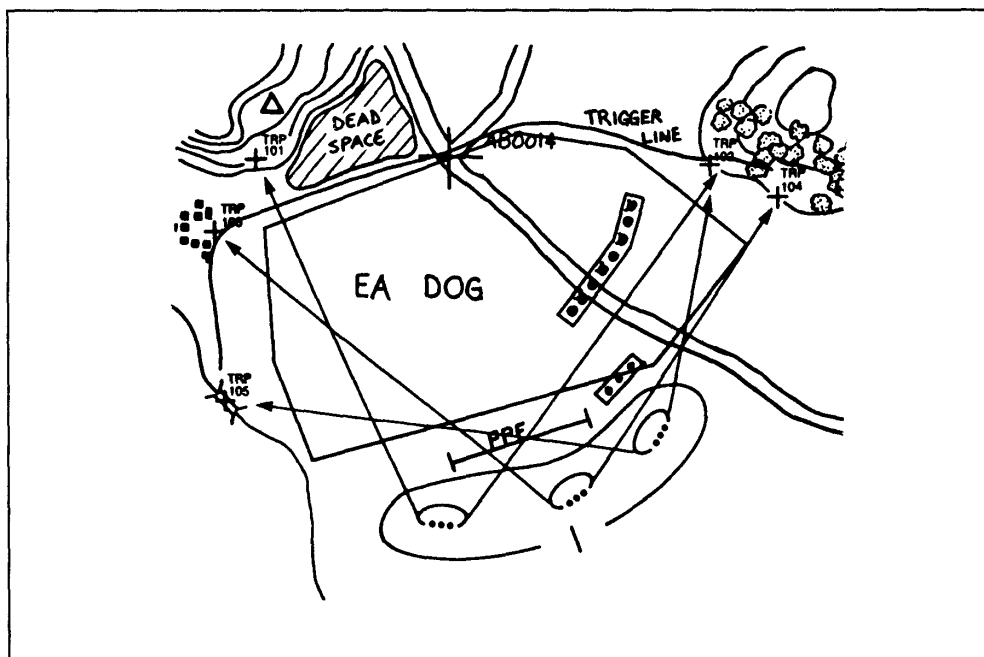

Figure 5-19. Company direct fire plan.

The sketch should include

- ' The company sector.
- Individual vehicle positions and platoon sectors.
- OPs.
- ' TRPs and EAs.
- Obstacles.
- Indirect fire targets.
- Dead space.
- The legend lists targets in the company's sector and M8s that can fire on those targets. It should also explain the direct fire and indirect fire graphics represented, as well as obstacles and barriers within the sector that can assist in the defense by canalizing the enemy into an EA. Standard military symbols are used to depict the obstacles and barriers, which should be covered by direct or indirect fire.
- Give a copy of the company fire plan to the light infantry company or TF commander as well as each of his M8 commanders.

## DEFENSE OF A BATTLE POSITION

The light infantry brigade uses the light armor company in a BP to concentrate its fires, limit its maneuver, or place it in an advantageous position to counterattack. The light armor company defends from a BP in the same way as the tank company. This type of defense is used to control fires and movement. It is designed to concentrate direct fires at critical places and times to take advantage of available terrain. The light infantry brigade commander will assign the light armor company a BP that dominates a main battalion-size enemy armor (mounted) avenue of approach.

The brigade commander specifies critical tasks for companies defending BPs. A minimum level of preparation is assigned at each battle position (occupy, prepare, or reconnoiter) to enable the company to accomplish its mission. The company is required to orient its weapon systems on an enemy avenue of approach using TRPs or EAs. The light armor company defends in a BP to accomplish one or more of the following:

- Destroy an enemy force in an EA.
- Control key terrain by holding the BP.
- Block an avenue of approach.
- Fix the enemy force to allow another unit to maneuver.

When defending a BP, the company positions its elements and maneuvers freely within the limits of the position to accomplish the commander's intent. If the company commander needs to position elements outside the BP to make better use of terrain, increase dispersion, or maximize his firepower, he should coordinate these locations with his senior commander.

## DEFEND IN SECTOR

The light infantry brigade uses a defense in sector to prevent an enemy force from passing the rear boundary of the sector. A defense in sector is used when—

- The enemy situation is vague.
- Multiple avenues of approach exist, precluding concentration of fires.
- Retention of terrain is not critical.
- Flexibility is desired.

When defending in sector, the brigade uses the depth of the sector to defeat the enemy within his boundaries while maintaining flank security and ensuring unity of effort. Sectors give the subordinate battalion TF commanders the freedom to decentralize fire planning. It allows the commanders to allocate his forces to suit the terrain and to plan in depth.

The light armor company will usually have platoons task organized to the forward defending infantry battalions, with at least one platoon (with infantry, TOWs, and/or other appropriate forces) retained as the brigade reserve under the command of the light armor company commander. Figure 5-20 shows an example of a brigade defense in sector with a supporting light armor company. This example shows three brigades (each with a light armor company team) defending in sector. The brigade on the left has one light armor platoon defending forward in sector with an infantry battalion and the remainder of the company in reserve. The middle brigade has all three platoons task organized to the battalions and the third brigade (on the right) employs the entire light armor company in a blocking position on a flank enemy mounted avenue of approach.

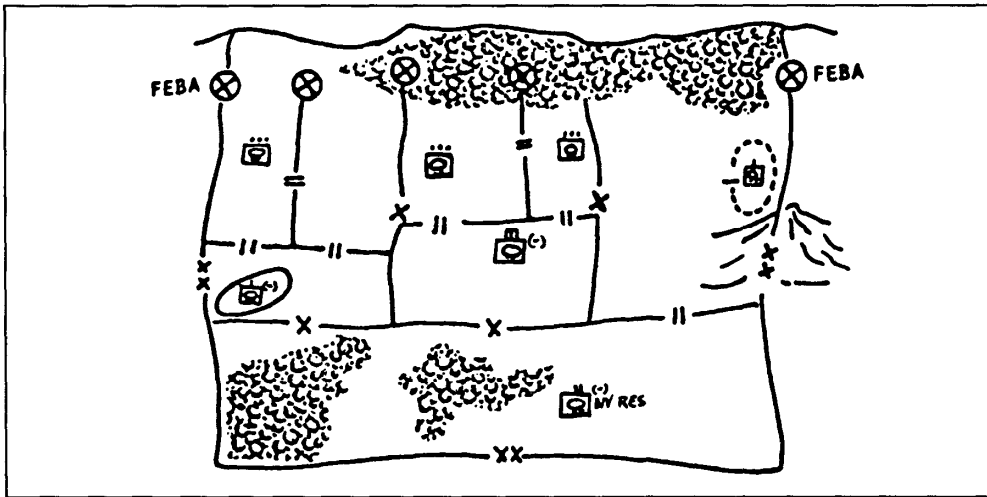

Figure 5-20. Light infantry brigade sectors showing examples of light armor company employment.

## DEFENSE OF A STRONGPOINT

A strongpoint is a defensive position that is fortified as extensively as time and materials allow. It is used to hold key terrain critical for the defense, to provide a pivot for the maneuver of friendly forces, and to canalize the enemy into friendly EAs.

A strongpoint is attacked at the risk of high casualties. It cannot easily be overrun or bypassed. It is tied in with existing obstacles, forcing the enemy to reduce it by dismounted assaults and massive artillery and tactical air concentrations.

While the size and type of force selected to execute a strongpoint defense will vary according to the situation, an infantry-heavy unit is normally used, with light armor retained for mobility. The light armor company can counterattack an enemy force that is halted by the strongpoint defense. Figure 5-21 shows an example of how the light armor company can be used in a brigade defense when one of the battalions is defending a strongpoint.

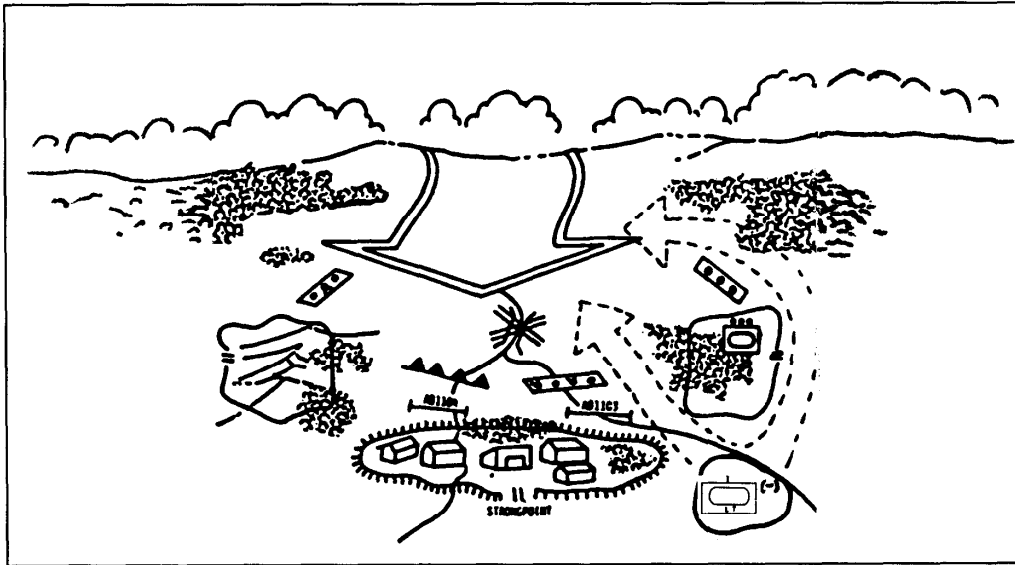

Figure 5-21. Light armor company supporting a strongpoint defense.

## PERIMETER DEFENSE

A defense of a perimeter is conducted in the same manner as that of a battle position except the perimeter defense orients on 360 degrees. Perimeter defenses are used to protect the force, hold specific terrain, or protect a key installation from destruction. The brigade uses this defensive technique when it must hold critical terrain and is not tied in with adjacent units, often employing light infantry. Common situations for use of the perimeter defense include—

- Defense of assembly areas.
- Defense of specific positions or key terrain.
- When the unit has been bypassed or isolated by the enemy.
- When the unit is in an airhead or lodgement.

While a BP can allow some penetration, a perimeter cannot. Subordinate battalions are assigned to defend specific portions of the perimeter. Flanks of all units are tied in to provide mutual support. If the perimeter is penetrated, the reserve blocks the penetration or counterattacks to restore the perimeter. The brigade plans positions in depth.

Light armor supports the brigade by providing platoons to the battalions that have enemy mounted avenues of approach into their portion of the perimeter. The remainder of the light armor company can be retained as a reserve. Figure 5-22 shows how a brigade can use a supporting light armor company in a perimeter defense.

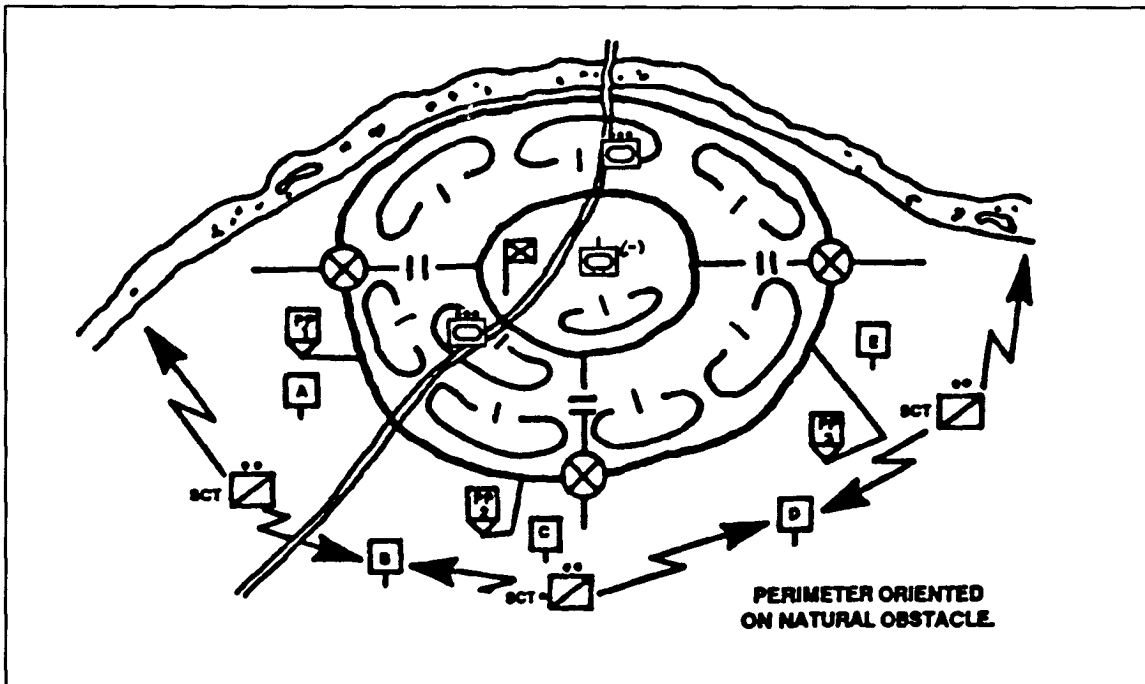

Figure 5-22. Light armor company supporting a perimeter defense.

## LIGHT INFANTRY ANTIARMOR DEFENSE

This defensive technique is normally used against an enemy armor threat in restrictive terrain. It is characterized by decentralized execution of detailed antiarmor ambushes and obstacles. This technique prevents the attacker from focusing his full combat power at one point. Its purpose is to destroy enemy forces through a series of antiarmor ambushes. It can be used to—

- Deny the enemy the use of a trail or road network in an area of restrictive terrain.
- Deny a choke point to the enemy. Based on the situation, this may be a mountain pass, a bridge crossing, or a highway through wooded terrain.
- Defend against a motorized enemy force that is attempting a move through restrictive terrain.
- Force the enemy into an EA allowing the unit to mass fires.

This defense allows for planned penetration, ambushes, and counterattacks throughout the enemy formation. It is the most offensively oriented defensive technique that light infantry can employ. The brigade assigns sectors to the battalions. The commanders analyze their sectors and organize to make maximum use of dispersed small-unit tactics (down to squad level) to attack the enemy throughout the depth of his formations.

The primary focus of this technique is on the enemy force. Indirect fires and obstacles are tied into the tactical plan to slow and/or stop the enemy in the EA. An aggressive patrol plan is used to provide security, report information, and harass the enemy in an effort to confuse him as to the location of the main defense.



An example of a light armor company supporting a brigade antiarmor defense is in Figure 5-23. The light armor company can be task organized to support the battalion's sectors or retained as a reserve and counterattack force to react to penetrations or exploit success. Light armor is used—

- When a motorized enemy is going to attempt a move through restrictive terrain.
- To maintain a mobile reserve to exploit success.

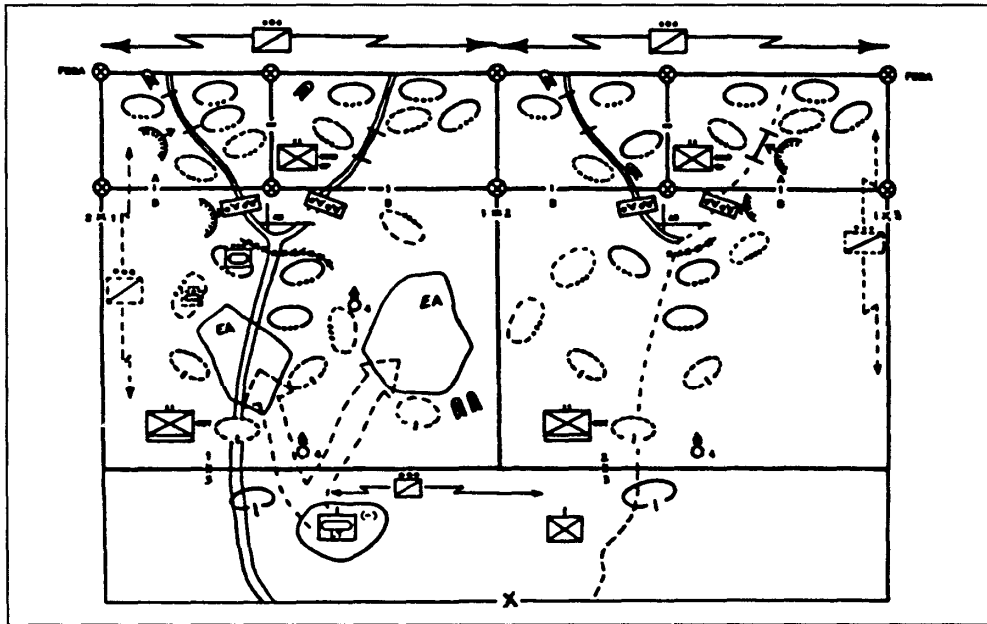

Figure 5-23. Light infantry brigade antiarmor defense.

## DEFENDING BUILT-UP AREAS

Light infantry commanders should consider the following when integrating M8s into the urban defense plan:

- Avoid combat within BUAs when feasible.
- Use restrictive missions and detailed control measures to facilitate decentralized execution and prevent fratricide.
- Provide priorities and deadlines for the accomplishment of assigned tasks.
- Attach CS and CSS units to the lowest level possible.
- Employ the combined arms team to maximize individual unit capabilities.
- Include M8 fires in the obstacle plan and counterattack plan.

- Light armor leaders must be informed of patrol plans to prevent firing on friendly units. Extensive infantry patrolling is conducted to prevent enemy infiltration. Long- and short-range recognition signals should be incorporated into the security plan.
- Some M8s may be held in reserve to counterattack enemy attempts to envelop the town while others provide direct FS for the infantry defense.
- Use small BUAs as obstacles when they add significant advantage to the direct fire plan.
- If terrain permits, establish light armor defenses as far forward of a BUA as possible.
- Integrate adjacent terrain into the defense.
- Use M8s to assist security forces in limiting enemy ground reconnaissance and infiltration.
- Light armor leaders must know what passive resistance measures have been taken along the enemy's avenue of approach, such as removing route indicators and minefield markers and weakening of bridges and culverts. M8 commanders must also know these plans. Failure to know what passive measures have been taken may cause unnecessary mistakes and/or injury to M8 crewmen.

The utility of M8s in defensive street fighting is limited. Streets and alleys provide restricted fields of fire. Restricted observation and the proximity of friendly troops to enemy targets limit the use of armor fires. Normally, only security elements are left in the town proper. The defenses are usually concentrated on favorable ground around it. When the town occupies the dominating terrain in the vicinity, however, it may be organized as a key part of the BP or strongpoint.

When the town is organized as a defensive position, the light armor commanders select primary, alternate, and supplementary positions. Because observation in any BUA is greatly restricted, OPs should be set up and communications improvised between them and the M8s. The OPs should not be placed in steeples, prominent towers, or other obvious locations that the enemy is likely to suspect and take under fire.

Light armor units are employed as in the defense of an organized BP. A small, well-organized, determined force defending in a BUA can hold off a much larger attacker for longer periods of time. Strongly constructed cities give the defender a decided advantage. Each building or group of buildings is a potential strongpoint.

When reconnoitering for covered routes of advance and withdrawal, light armor unit commanders should not overlook the possibility of moving through ground floor lobbies and corridors of the larger buildings. This type of route requires careful marking, but has the advantage of being largely concealed from aerial observation. A careful reconnaissance, made with engineer assistance if possible, is necessary to determine whether the floors will support the M8s.

## OTHER DEFENSIVE TASKS

**Reserve Force.** Early in the planning stage, the commander should make important decisions concerning the size, composition, and mission of the reserve. The primary purpose of the reserve is to retain flexibility, reinforce success, or regain the initiative. The light armor company must be able to accomplish one or more of the following subsequent missions:

- Counterattack.
- Reinforce a BP, sector, or strongpoint.
- Assume the mission of another unit.

When employed in a positional defense, such as perimeter defense or a BP, reserves can be used to conduct attacks against enemy penetrations by striking a decisive blow against an uncovered enemy flank. Additionally, should the enemy's attack fail, reserves could be used to reinforce success. When assigned the reserve mission, the light armor company—

- Occupies the reserve position (BP or assembly area).
- Reconnoiters the sector or BPs, concentrating on areas being considered for subsequent missions.
- Rehearses likely subsequent missions.
- Maintains the appropriate readiness condition to react promptly to on-order missions.
- Uses deception to reduce the enemy's ability to locate the M8s.

**Counterattack Force.** The company may participate in a counterattack to exploit an existing enemy weakness in the company's AO. An element counterattacks to—

- Destroy enemy units.
- Regain freedom of maneuver.
- Regain the initiative.
- Regain key terrain.
- Relieve pressure on an engaged unit.

A company executes two types of counterattacks:

- **Counterattack by fire.** A counterattack by fire is executed to complete the destruction of exposed enemy elements, to free decisively engaged elements, and to regain the initiative. The company executes a counterattack by fire by moving on a concealed route to a predetermined BP from which it can engage the enemy in the flank and/or rear while the remaining units hold their positions and continue to engage and maintain contact with the enemy (see Figure 5-24). When necessary, the company commander requests permission to maneuver outside the boundaries of the predetermined BP; he accomplishes this through prior planning, coordination with the commander, or an immediate request. If this maneuver influences another unit's mission, the company commander is responsible for coordination with that unit.

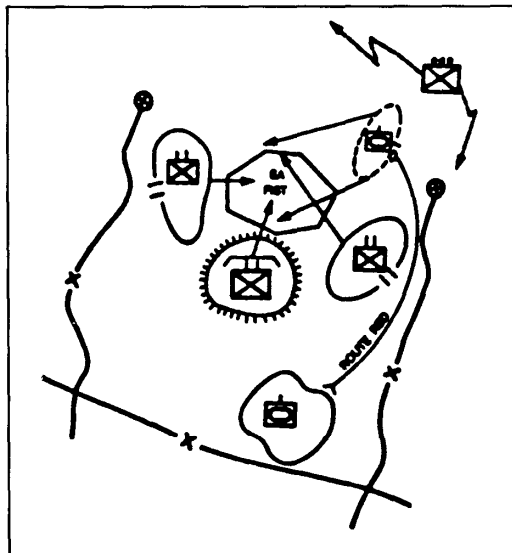

Figure 5-24. Counterattack by fire.

- **Counterattack by fire and maneuver.** A company normally conducts a counterattack by fire and maneuver to destroy the remaining enemy completely, to relieve pressure on a friendly unit, or to regain key terrain. The counterattack force attacks the enemy from the flank whenever possible, using fire and movement to overwhelm and destroy him.

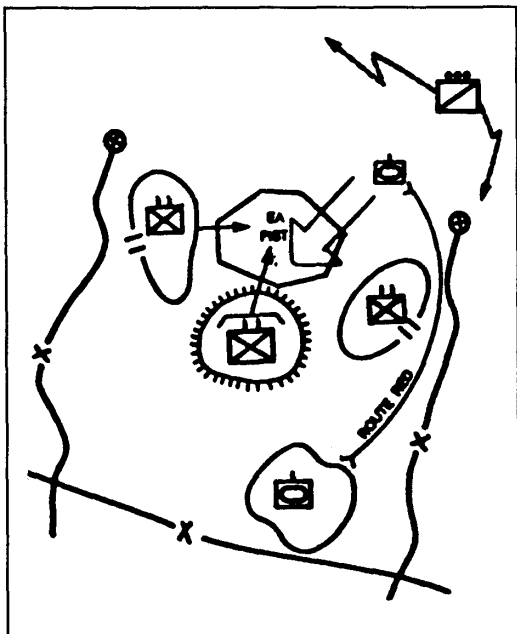

Figure 5-25. Counterattack by fire and movement.

The company conducts the counterattack by fire and movement in a manner similar to a hasty attack (see Figure 5-25).

## LIMITED VISIBILITY

Light armor companies can expect to conduct defensive missions in limited visibility while supporting light infantry. The enemy will attempt to take advantage of the conditions to bypass or get close to defensive positions without being detected. The fundamentals of defensive operations do not change. Light infantry units will take special measures during limited visibility, such as increasing the number of patrols between positions. Depending on the situation, commanders can use the following techniques during limited visibility:

- Use M8 thermal sights for detection on defined avenues of approach. Integrate their use into the company fire plan.
- Reposition weapons to concentrate on the avenues of approach that the enemy is likely to use during limited visibility.

- Plan and rehearse required movement of units and massing of fires.
- Plan to reposition weapons to compensate for the disparity between day and night acquisition ranges.
- Reconnoiter the limited visibility positions, mark them, and mark the routes to them.
- Strengthen security with additional OPs and turret personnel.
- Enforce noise and light discipline.

## Section VI. Other Operations

### LODGEMENTS

The light armor company will perform the same functions as the platoon during lodgement seizure and expansion. See Chapter 4 for more details. The advantage of the light armor company in the lodgement is that one or two platoons can be placed forward with infantry to block mounted avenues of approach while at least one platoon is maintained as a reserve.

### RETROGRADE OPERATIONS

Three types of retrograde missions are assigned to the light armor company: delay, withdrawal, and retirement.

**Delay.** The purpose of delay is to slow the enemy by trading terrain for time while inflicting maximum damage. Enemy forces are delayed by the effective use of obstacles, firepower, and terrain. Delaying forces avoid decisive engagement.

The light armor company can conduct a delay alone or as part of a larger unit. The considerations of planning and executing a delay at company level are the same as described in Chapter 4.

There are two types of delays:

- Delay in sector. This mission allows the most freedom to use the terrain as you see fit. There is usually no requirement to hold key terrain when conducting this type of delay.
- Delay forward of a line. This is a high-risk mission that requires preventing enemy forces from reaching a specified area earlier than the specified time or event, regardless of the cost. The commander will normally limit the maneuver from BP to BP or will restrict crossing a particular PL based on a specific time or event.

The two basic methods of conducting delays at the company level are described in the following paragraphs:

- From successive positions or PLs. This method is used when the mission requires covering a wide sector or avenue that is open and difficult to cover with light infantry. All or most of the light armor company must be deployed forward to cover the area. This method is also used when terrain does not allow for depth. As the fight progresses, the company fights from PL to PL. The platoons disengage separately from one PL or BP to the next while the remaining platoons provide overwatch (see Figure 5-26). In some cases, the enemy may force the company to disengage simultaneously. Bounding within the platoons may be necessary when the terrain restricts the platoons' ability to provide overwatch for one another.
- From alternate positions. When the AO is deep and narrow enough to be covered by one or two platoons, more depth and security can be achieved by delaying from alternate positions (see Figure 5-27 on page 5-36). This maneuver does not normally allow all of the platoons to place fire on the enemy at one time. It is more difficult to control because platoons are moving and fighting simultaneously. The platoons have more time to establish their next positions, however, because other platoons are fighting and providing security.

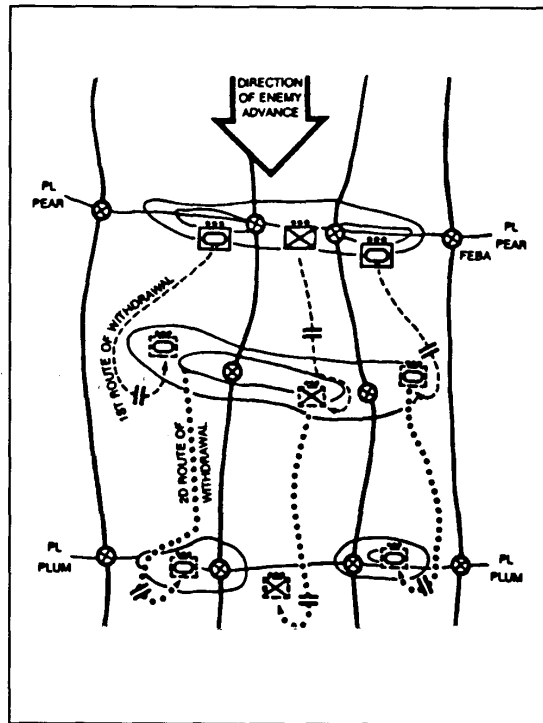

Figure 5-26. Delay from successive positions.

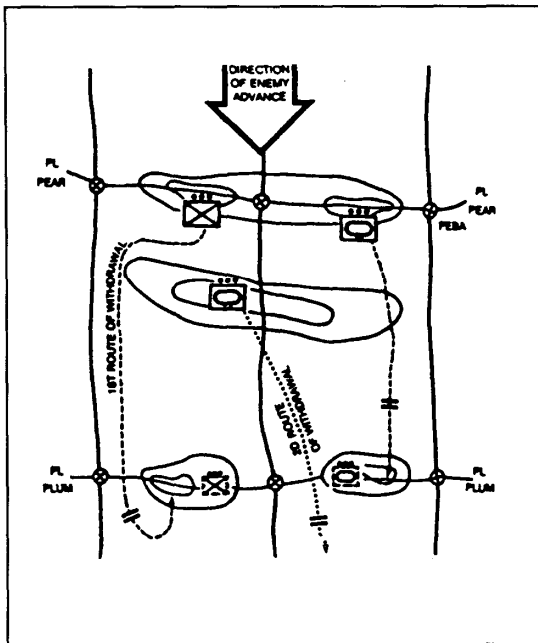

Figure 5-27. Delay from alternate positions.

**Withdrawal.** The purpose of a withdrawal is to disengage from the enemy. To successfully conduct a withdrawal, light forces need mobility equal to or greater than that of the enemy. There are two types of withdrawals:

- A withdrawal under enemy pressure requires the unit to maneuver to break contact when it is under attack from the enemy. A unit conducting a withdrawal under enemy pressure is organized into a security force and a main body. The withdrawal should always be conducted with the goal of avoiding discovery. Timing is critical. The unit must disengage by using massed fires and redeploy before the enemy can react to its movement.
- Withdrawal not under enemy pressure requires deception and speed. The unit is not under attack and does not expect to be attacked during the withdrawal. During the withdrawal, deception and OPSEC are stressed. A unit conducting this kind of withdrawal from a defensive position is organized into a main body and a DLIC.

The withdrawal plan must be modified to fit the technique used to defend or delay. Defense or delay techniques that are fluid and use a series of ambushes and raids to accomplish the mission can be used with withdrawal techniques associated with those operations. Defenses or delays that are more static require different withdrawal techniques. The techniques used for a light armor company to support the infantry brigade withdrawal are similar to the way the light armor platoon supports the infantry battalion withdrawal as described in Chapter 4. The withdrawal requires the force to designate a DLIC, security force, and quartering parties, which are described below:

**Detachment left in contact.** The size, makeup, and mission of the DLIC are directed by the brigade commander. He will also name the DLIC commander. This is normally the XO. DLIC composition is dependent on the terrain and enemy situation. Although one could be the DLIC, each battalion normally will leave a company as its part of the brigade DLIC. This DLIC must be a mobile force. The light armor company with HMMWV TOWs (configured with machine guns) can provide the mobility needed to cover the withdrawal of the brigade main body.

**Security force.** The security force conceals the withdrawal of the main body and deceives the enemy by continuing the normal operational patterns of the battalion. If the enemy attacks during the withdrawal, the security force covers the withdrawal with fires. Priority of artillery and mortar fires is given to the security force. Once the battalion has reached its next position or a designated distance from the old position, the commander withdraws the security force. If it is under attack, the security force may have to maneuver to the rear until contact is broken.

- **Quartering party.** Each battalion sends a quartering party to the next position before the withdrawal starts. As their units arrive at the new location, members of the quartering party act as guides to lead elements into their new positions.

**Retirement.** Retirement is an operation where a force not in contact moves away from the enemy to avoid combat under unfavorable conditions. A withdrawal from action becomes a retirement after the main force has disengaged from the enemy and march columns have been formed. A retirement may be made to increase the distance between the defender and the enemy, to occupy more favorable terrain, to reduce the distance between maneuver and CSS elements, to conform to the disposition of a higher command, or to permit employment of a unit in another sector.

Planning considerations for a retirement are similar to those for delay and withdrawal. Movement during reduced visibility is preferred. The light armor company may be required to move on one or more routes to support the brigade.

The M8s can provide the appropriate forward, flank, and rear security. When contact with the enemy is possible, such as when a withdrawal has preceded retirement, a strong rear security is normally employed. If the enemy attacks the rear, delay tactics are used by the rear guard to extend the distance between the main body and the enemy. The keys to a successful retirement are dispersion, speed, and security.

## CONVOY SECURITY

Light armor is well suited to provide the mobile, protected firepower to deter attacks on convoys. Convoy security is described in more detail in Chapter 4. The same planning considerations apply at the company level.

The size of the force allocated to provide convoy security is driven by METT-T. The TF commander may decide to task organize a combined arms team to secure convoys, or a light armor company may be tasked to provide convoy security. The light armor company commander may act as the convoy security commander.

**LIGHT ARMOR BATTALION**

This chapter describes employment considerations for the light armor battalion supporting a light infantry division. The light armor battalion can deploy as an organic unit, as companies, or platoons task organized to infantry TFs. The battalion may move into a theater as the majority of a light division is deployed. The light armor units may be organized as a TF when a large enemy armor threat exists and/or escalation of hostilities is expected. When the battalion functions as a TF, its basic employment is to counter enemy armor threats until heavier forces arrive in theater.

**CONTENTS**

	Page
Section I. Organization . . . . .	6-2
Light Armor Battalion . . . . .	6-2
Headquarters and Headquarters Company. . . . .	6-3
Scout and Mortar Platoons . . . . .	6-3
Section II. Employment . . . . .	6-4
Missions . . . . .	6-4
Operational Planning Considerations. . . . .	6-4
Section III. Command, Control, and Communications. . . . .	6-5
Leader Groups . . . . .	6-5
Command and Control Facilities. . . . .	6-6
Command Post Procedures . . . . .	6-6
Communications . . . . .	6-8
Formations . . . . .	6-10
Section IV. Offensive Operations. . . . .	6-12
Movement to Contact. . . . .	6-12
Hasty Attack. . . . .	6-13
Deliberate Attack. . . . .	6-14
Exploitation . . . . .	6-15
Pursuit . . . . .	6-16
Raid . . . . .	6-16
Section V. Defensive Operations. . . . .	6-17
Defend in Sector. . . . .	6-18
Battle Positions . . . . .	6-19
Other Defensive Tasks. . . . .	6-20



CONTENTS (Cont)	Page
Section VI. Other Operations . . . . .	6-20
Retrograde . . . . .	6-20
Reconnaissance in force . . . . .	6-21
Counterreconnaissance . . . . .	6-21
Passage of Lines . . . . .	6-24
Relief in Place . . . . .	6-27

## Section I. Organization

### LIGHT ARMOR BATTALION

The light armor battalion is organized into four light armor companies and a headquarters company. Figure 6-1 shows the battalion organization.

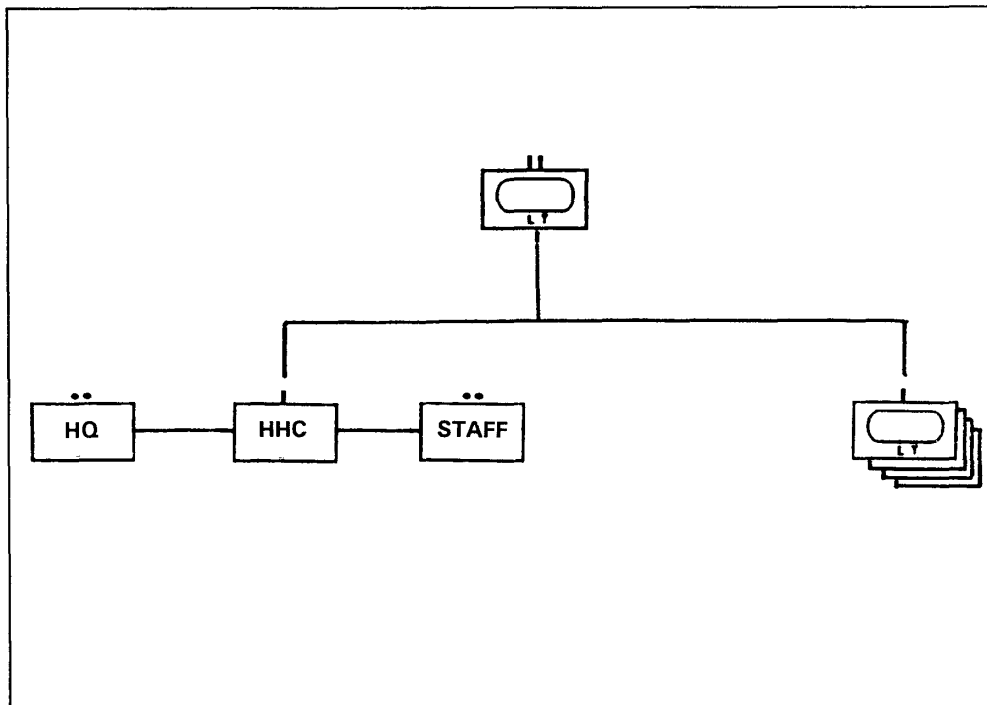

Figure 6-1. Light armor battalion.

## HEADQUARTERS AND HEADQUARTERS COMPANY

The headquarters and headquarters company (HHC) in a light armor battalion is organized as shown in Figure 6-2. Unlike the tank battalion, it must support four light armor companies that usually support three different infantry brigades. Many times, the platoons within the companies are supporting nine different infantry battalions within the brigades. Consequently, control of the support assets within the HHC are decentralized; strong leadership, flexibility, and effective planning are necessary to accomplish the support mission.

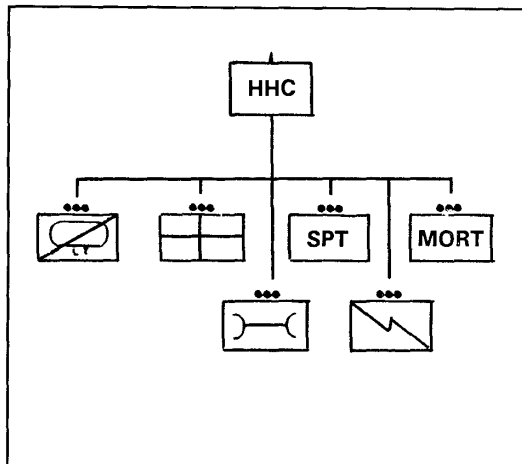

Figure 6-2. Headquarters company.

## SCOUT AND MORTAR PLATOONS

The battalion scout platoon performs reconnaissance, provides limited security, and assists in controlling movement of the battalion TF. The scout platoon is one of the commander's primary sources of combat intelligence before the battle and is his eyes and ears during the battle. The platoon is not organized or equipped to conduct independent offensive, defensive, or retrograde operations. It operates as part of the battalion and should be assigned missions that capitalize on its reconnaissance capabilities. The mortar platoon is also organic to the battalion. It has high-angle, relatively short-range area fire weapons, and is well suited for providing close indirect FS. See Chapter 7, and FM 7-90. Figures 6-3 and 6-4 illustrate the organization of the scout platoon and the mortar platoon.

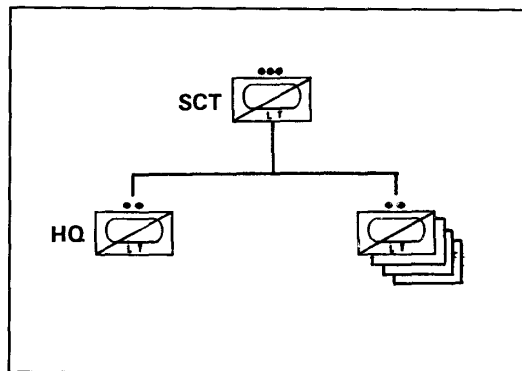

Figure 6-3. Scout platoon.

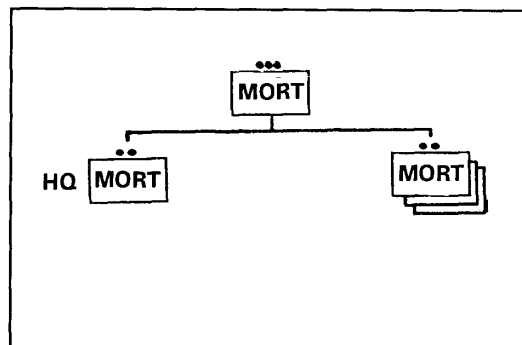

Figure 6-4. Mortar platoon.

## Section II. Employment

The light armor battalion can operate as a pure battalion or deploy in echelons as companies and platoons attached to infantry brigades and battalions respectively. If the entire infantry division deploys, part of the battalion may consolidate once in theater. The battalion headquarters then forms the nucleus of a light armor battalion TF.

The light armor battalion provides the LID commander with the following:

- A highly mobile, protected potent ground combat force.
- Shock effect.
- Effective antiarmor capability.
- Bunker- and building-busting capability and direct, close-in FS for dismounted infantry.

The light armor battalion may conduct operations as a battalion TF under the following conditions:

- The enemy has a considerable mechanized or armor force.
- A contingency mission has matured to a level in which the entire LID has deployed to include the light armor battalion.
- Terrain favors the use of a larger maneuver force and/or supports long-range fires.

### MISSIONS

The light armor battalion can expect to execute the following missions:

**Attack.** The battalion provides the infantry division commander with his most maneuverable, survivable, and potent ground force on the battlefield. He may use this capability either to lead the division to fix the enemy force or as his maneuver force. Keep in mind the battalion's speed in relation to the speed of the predominantly dismounted force. The division commander can use this to his advantage by buying time to maneuver his infantry units. Infantry moving with the light armor TF must be mobile. Truck transportation assets are available in the TF, however, if more than one company requires transportation, trucks must come from corps support.

**Defend.** In open terrain, the battalion is most effective when operating as a total unit. In closed terrain, better suited for light infantry, the battalion is most effective operating alongside the infantry as platoons and companies OPCON to the infantry battalions and brigades defending in depth.

**Screen/Guard.** The division commander may give the light armor battalion deployment priority if the enemy threat is predominantly mechanized or is in wide-open terrain allowing long-range fires. The battalion in this circumstance may be tasked to establish a screening force to provide security for the division as it flows into the AO. As the division builds in theater, the battalion's screening mission may end, and the companies and platoons within the battalion may augment the infantry brigades once again. In a major force buildup involving the arrival of cavalry, armored, or mechanized forces, the battalion may be relieved.

### OPERATIONAL PLANNING CONSIDERATIONS

**Intelligence.** The battalion scout platoon offers a reconnaissance force for both the battalion and division. Ground surveillance radar (GSR) may be attached from the division's military intelligence (MI) battalion. The battalion relies on the division's intelligence assets for intelligence beyond their own ability to collect.

**Maneuver.** These planning considerations apply:

- The attachment of dismounted infantry companies to the light armor battalion will require external transportation support from corps.
- The light armor battalion relies on the attachment of light infantry for close-in security in closed terrain.
- The light armor battalion's ground mobility is its greatest asset, the battalion can move faster than any other divisional ground combat element.

**Fire Support.** The battalion FSO is not equipped with an armored vehicle but must be positioned to maintain communications with subordinate FISTs, the battalion FSE (usually located with the TOC), and supporting FS assets. Positioning is based on METT-T; one solution is to position the battalion FSO in the battalion TAC CP.

The high mobility of the light armor battalion, when compared with the remainder of the divisional combat power, may require additional fire support assets that can be positioned in direct support of the light armored battalion.

The use of submunitions may be affected by their potential for nonexploded ordnance (UXO), and as a hazard to friendly light forces.

**Air Defense.** The battalion requires air defense augmentation. Light armor's presence in a predominantly dismounted AO makes it easily identifiable from the air and a high-value target for enemy attack aircraft. Smoke blankets defeat enemy aircraft targeting and increases the survival of the light armor battalion.

**Mobility and Survivability.** The light armor TF will normally have at least one company of corps engineers in its task organization. The engineer company will have the capability to provide a full range of mobility, countermobility, and survivability tasks, to include assault gap crossing, complex obstacle breaching, preparation of fighting positions, emplacement of conventional and dynamic minefield, and construction of nonexplosive obstacles. Leaders must know the location of NBC hazards to reduce the vulnerability and risk level of the light armor battalion.

**Combat Service Support.** The battalion does not require transportation augmentation if it deploys in its entirety. Additional corps maintenance support may be required as described in Chapter 8.

**Command and Control.** The light armor battalion should provide a liaison to the division headquarters for staff coordination to enhance C2.

## Section III. Command, Control, and Communications

### LEADER GROUPS

Several types of leader groups work closely with the commander to provide effective C2. The commander determines who he wants in each group and establishes a standing list as part of his SOP.

**Command Group.** The command group consists of the commander and those he selects to go forward to assist him in controlling maneuver and fires during the battle. It normally includes the FSO, forward air controller, FAC, and S3. There is no requirement for these people to collocate. For example, the commander may be in one part of the battalion sector while the S3 works in a separate part of the sector. The composition, nature, and tasks of the command group are determined by the commander to permit the optimum C2 of his unit during the battle.

**Leaders Reconnaissance Group.** The leaders reconnaissance group is a standard list of personnel who accompany the commander on his reconnaissance during troop-leading procedures. It usually includes the command group, the company commanders, and key attachment leaders (such as the ADA officer and engineer).

**Orders Group.** The orders group is a standard list of personnel the commander wants present when he issues orders or that serves as a distribution list for orders. It usually consists of the leaders reconnaissance group, the XO, S1, S2, S4, battalion chemical officer, smoke/decontamination platoon leader, scout platoon leader, and mortar platoon leader.

## COMMAND AND CONTROL FACILITIES

**Tactical Command Post.** A TAC CP may be formed during fast-moving offensive or retrograde operations to maintain communications and facilitate the movement of the main CP. In each circumstance the commander may designate one of the CP vehicles from the main CP to act as the TAC CP. Some or all of the command group may locate at the TAC CP at various times.

In some circumstances, the TAC CP may be part of an opposed-entry airborne assault. It is then referred to as the assault CP. The assault CP vehicle is usually a HMMWV with the minimum communications equipment and mapboards needed to control the unit. However, the assault CP may merely be the command group and enough man-packed communications equipment to control the light armor units deployed in the initial assault until follow-on operations deliver the TAC CP vehicles.

**Main Command Post.** The TF main CP is the control, coordination, and communications center for combat operations. The main CP is composed of the S2 and S3 sections, the FSE, representatives from other attached elements, and the TAC CP (when not forward). There must be as few main CP vehicles and personnel as possible to allow for rapid displacement, but the main CP must be large enough to accomplish C2 functions in support of the commander.

**Combat Trains Command Post (CTCP).** The CTCP is the coordination center for CSS for the TF and the control element of the combat trains. It is positioned forward of the field trains. The S4 is responsible for operations, movement, and security of the combat trains, assisted by the S1. The S4, S1, and battalion maintenance officer (BMO) must continually assess the situation, anticipate the needs of units, and prepare to push support forward. Anticipating requirements is the key to successful CSS.

The CTCP is the alternate main CP. It must be prepared to assume the functions of the main CP at any time. It monitors the TF command net and maintains charts and tactical situation maps identical to those at the main CP. The CTCP routinely operates a switchboard for elements in the combat trains; it is the NCS for the battalion A/L net and operates in the brigade A/L net.

## COMMAND POST PROCEDURES

**Staff Journal.** Each CP cell should maintain a staff journal. The soldiers on duty in the cell maintain the journal on DA Form 1594. They record important events, such as—

- Command decisions.
- Movements of units.

- Changes in unit status.
- Liaison activities.
- Receipt of new or amended orders.
- Visits of commanders and staff officers from other headquarters.

The on-duty soldier logs each action he took in response to an event. He may use abbreviations or symbols. When he is preparing to go off shift, he makes special notations of events requiring action by soldiers on the next shift.

Staff officers and NCOs use the staff journal as a record for review by incoming duty personnel. It ensures continuity between shifts in a CP in that personnel on the incoming shift know which staff actions need further work. It provides a ready reference for the commander and staff to review current orders. The journal also serves as a permanent record for after-action reports, operational reviews, and historical research.

**Map Boards.** All map boards should be capable of being mounted inside the CP vehicle. Several other techniques are available for constructing map boards. They should be made of material thick enough to withstand periodic dismounting and mounting. They should also be constructed so that the maps can be quickly and easily changed. Overlays should be manufactured to a standard size, with holes to fit standard mounting hooks (referred to as “standard drops”). Staffs should ensure that no map board has so many overlays that it is no longer understandable or that its main purpose is lost. Maps commonly used in the CP include the following:

- **Situational map.** The situational map is maintained by the S3. It illustrates, through the use of military graphic symbology, the friendly array of combat, CS, and CSS assets as well as the maneuver plan overlay. Unit SOP will dictate which specific graphics will be placed on which overlays.
- **Intelligence map.** The intelligence map is maintained by the S2. It illustrates disposition through the use of military graphic symbology all enemy forces to include combat elements, obstacles, and fortifications.
- **Fire support map.** The FS map is maintained by the battalion FSE and is used in the planning and coordination of FS, target acquisition, and clearance of indirect fires. The FS map is used with the S2’s intelligence map to develop high payoff targets and ensure detection and attack assets can be committed against those targets.

**Information Charts.** Standard information charts are used to effectively maintain and organize essential information. Staff officers display critical information so that they can view or update it while looking at the map. Staffs should only post information that they will reference often or that is vitally important. Information charts on map boards should not be a replacement for critical information charts kept in the staff workbook.

**Orders Preparation, Reproduction, and Dissemination.** CP SOPs should contain procedures for preparation, reproduction, and dissemination of overlays and written orders.

Possible topics include–

- Who draws overlays and graphic control measures.
- Who approves overlays.

- Standardized fall-in-the-blank forms for orders.
- Who writes FRAGOs and OPORDs.
- Who is responsible for providing data for each paragraph.
- Who is responsible for the reproduction of overlays.
- How overlays are reproduced (computer or mechanical means or by hand); if by hand, who assists in copying overlays and where copying is done.
- How many copies of overlays and orders are made (providing multiple copies to each subordinate saves the subordinate time).
- How orders are distributed.

## COMMUNICATIONS

Battalion TF communications are sent over a variety of radio nets. Figure 6-5 illustrates battalion radio nets.

Primary battalion communications nets are—

- **Command net.** A secure command net is used for C2 of the TF. All organic and attached units, including the FSO, FAC, and leaders of supporting elements, operate on the TF command net. During the execution of the mission, only commanders transmit; all others monitor and transmit only essential information. The command net is controlled by the TF CP.
- **Operational and intelligence (OI) net.** This OI net is a secure net established to provide a mechanism for the battalion TF to accept routine reporting of information concerning OI matters and without cluttering or interfering with the battalion command net.
- **Administrative/logistics (A/L) net.** The A/L net is a tactical net, that is controlled by the combat trains CP and used to communicate the A/L requirements of the TF. All organic and attached units normally operate in this net.
- **Special radio nets.** These include the following:
  - The scout platoon net or a designated frequency may function as a surveillance net when required. The S2 and elements assigned surveillance missions operate on this net. Other elements enter or leave the net to pass information as required.
  - The TF FSE and company FIST operate in the supporting field artillery command fire direction net and a designated fire direction net to coordinate field artillery fires for the battalion. The tactical air control party (TACP) operates in USAF tactical air-request and air-ground nets to control air strikes.
  - Supporting air defense units monitor the early warning net. In the absence of collocated air defense support, the main CP will also monitor the division early warning net.
  - OPCON or attached support assets may operate in their parent unit nets, but they must also monitor the command net at all times.

	TF CMD	TF O&I	TF A/L	OTHER
CDR	P	-	E	P - DIV CMD
XO	P	-	P	
S3	P	M	-	M - DIV CMD
MAIN CP (S3)	NCS	-	M	P - DIV CMD
MAIN CP (S2)	M	NCS	-	P - DIV O&I
COMBAT TRAINS CP	M	-	NCS	P - DIV A/L
SIGNAL OFFICER	M	E	M	E - AS REQUIRED
FSO	M	-	-	M - TF FD, FS NETs
FAC	M	E	-	P - AIR FORCE NETs
S1	-	-	M	
S4	M	-	P	E - AS REQUIRED
BMO	M	-	P	
SPT PLT	M	-	P	
MED PLT	-	-	P	
CO/TM CDRs	P	E	-	P - CO/TM CMD
CO/TM XO <sub>s</sub>	M	-	E	P - CO/TM CMD
CO/TM 1SG	-	-	P	P - CO/TM CMD
ENGR CO	M	E	E	P - ENGR CO
SCOUT PLT	P	P	E	P - SCOUT PLT
ADA PLT	M	E	E	P - ADA PLT; EW
MORTAR PLT	M	-	E	NCS - TF FD NET
GSR	M	P	E	
HHC CDR	-	-	P	P - DIV A/L
LO	M	E	-	M - AS ASSIGNED

**NCS - NET CONTROL STATION FOR NET**

**P - PRIMARY USERS - MONITOR AND TRANSMIT**

**M - MONITOR NET, TRANSMIT AS REQUIRED**

**E - ENTER NET TO TRANSMIT MESSAGE, THEN RETURN TO PRIMARY NET**

Figure 6-5. Battalion radio nets.



**FORMATIONS**

The light armor TF may move in any of the basic formations. It may use more than one formation in a given movement if the terrain changes. Light infantry should be mounted on trucks (if available) or on follow-on company team vehicles if speed is important or the move is long. Other factors such as distance between units are dependent on METT-T. Figures 6-6 through 6-8 are examples of light armor TF formations.

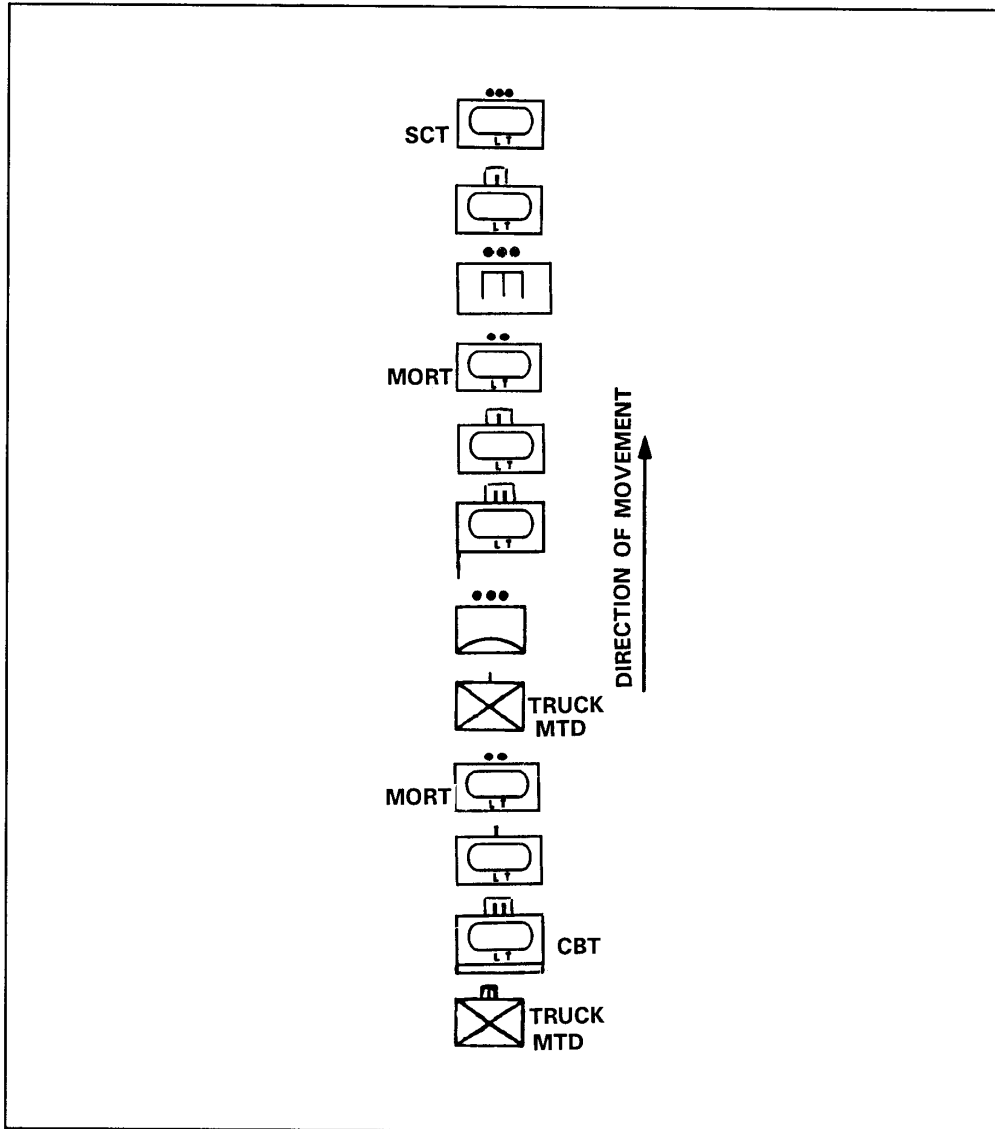

Figure 6-6. Task force column.

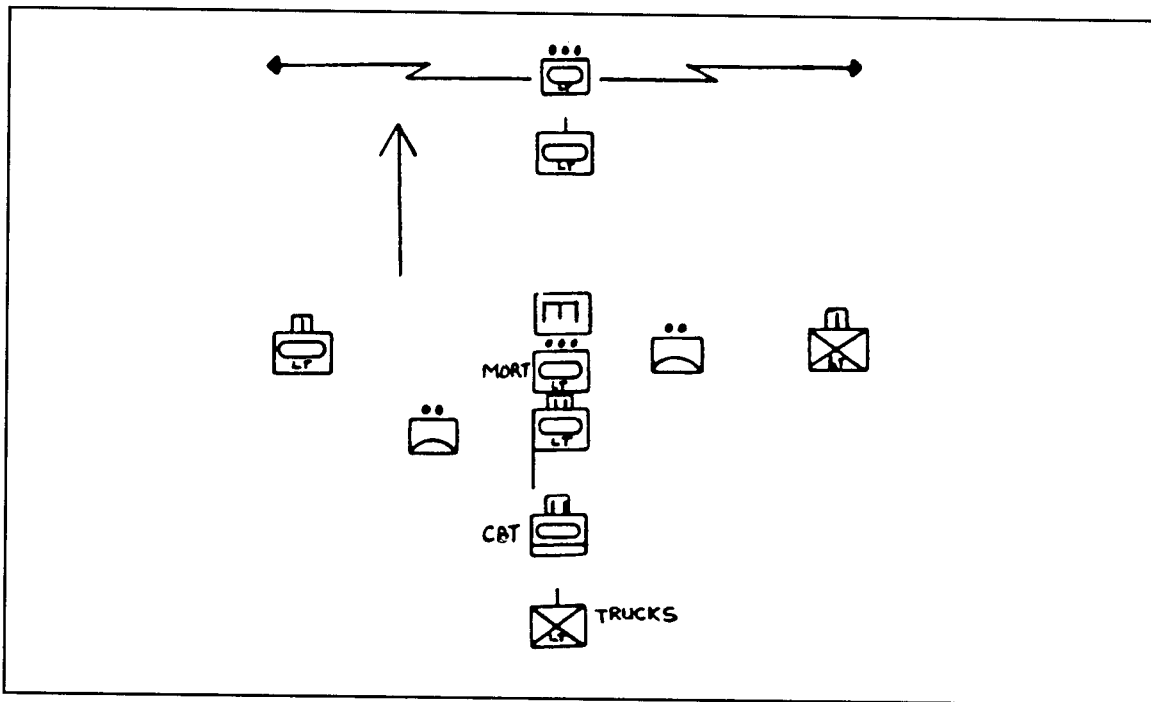

Figure 6-7. Task force wedge.

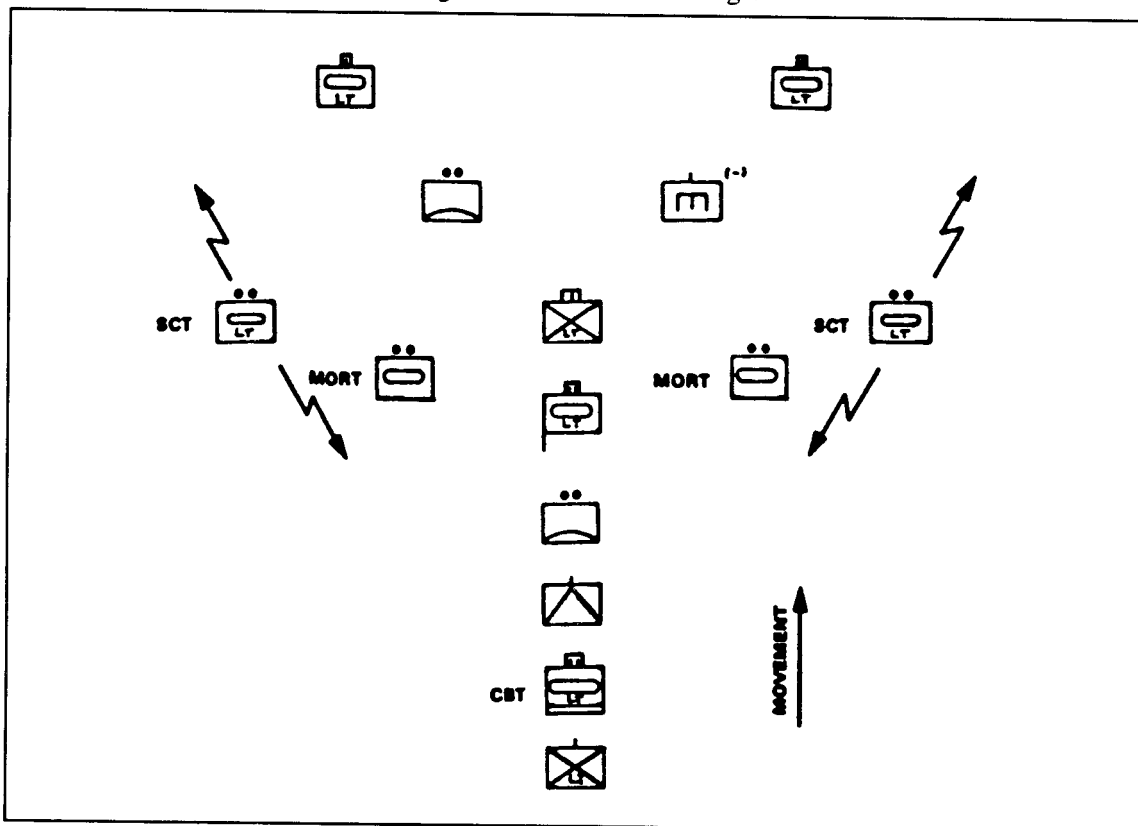

Figure 6-8. Task force vee.

## Section IV. Offensive Operations

### MOVEMENT TO CONTACT

The battalion TF conducts a movement to contact to make or regain contact with the enemy and to develop the situation. The battalion TF could be given a movement to contact mission as the lead element of a brigade or division attack, or as a counterattack element (see Figure 6-9). Movement to contact terminates with the occupation of an assigned objective or when enemy resistance requires the battalion to deploy and conduct an attack to continue forward movement.

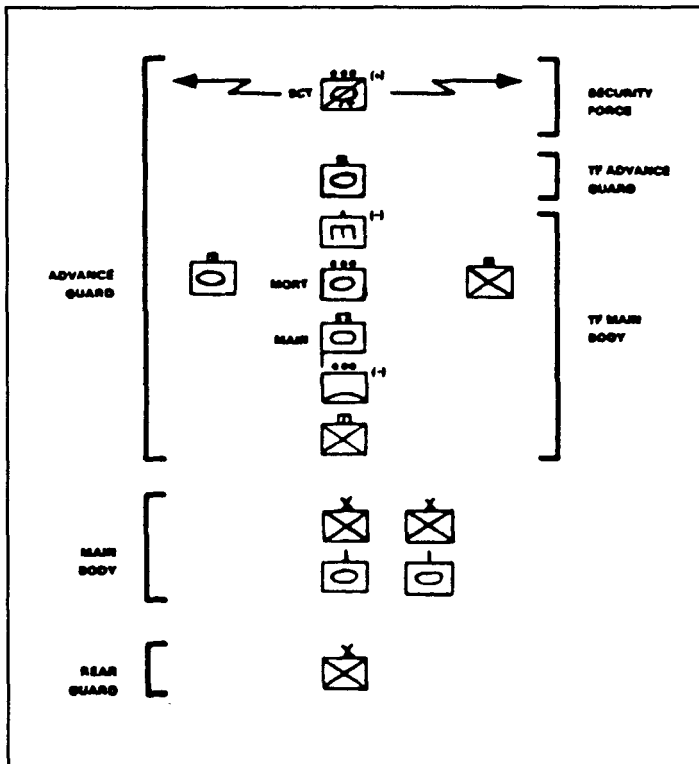

Figure 6-9. Light armor task force movement to contact as lead for a division attack.

**Planning Considerations.** Key planning considerations for a movement to contact unique to a light armor battalion are—

- Speed required by the division. The rate of march of the light armor battalion can easily exceed the rate of march of the other infantry TFs.
- Available avenues of approach. The light armor battalion should move along an axis of advance that maximizes its firepower and maneuverability.
- Requirements to maintain mutual support and synchronization between maneuver units, security, and FS.

**Task Organization.** The TF is organized with a security force, advance guard, main body, and flank and rear guards.

The following considerations apply:

- The security force is normally established with the light armor battalion scout platoon which is equipped with HMMWVs. The scout platoon may be augmented with TOW-equipped HMMWVs (task organized from an infantry brigade) or M8s to provide long-range antitank capability in the security force. Planners must consider trafficability of the terrain since the wheeled scouts are not as maneuverable as the tracked M8s.
- The advance guard is usually a company team. Company teams are task organized, with light armor and infantry platoons forming a mutually supporting team. Attached infantry may move with the company team by a variety of means. The infantry may move dismounted, mounted on top of the M8s, or mounted in trucks until contact is made or the situation requires the infantry to dismount.

- The company team may be augmented with TOW HMMWVs from the infantry battalions if long-range antitank overwatch is desired. Other attachments may include an engineer platoon or squad (HMMWV-equipped) and an ADA section. See Chapter 5 for additional information on company team operations.
- The main body remains behind the advance guard lead element, keying its movement to that of the advance guard. It is flexible enough to maneuver rapidly and provide responsive support when committed. The main body contains the bulk of the TF's combat force; it may be augmented with additional assets including TOW HMMWVs from the infantry battalions' antitank platoons, engineers, ADA sections, and GSR. Infantry in the main body moves in trucks if possible.
- Flank security is normally accomplished with platoon-size elements (under company control) from one or more of the companies in the main body. The flank guard in a light environment may be HMMWV-equipped elements from the battalion's scout platoon or attached antitank platoons.
- The trailing company of the main body provides a rear guard to protect the TF's rear.
- CSS assets move with the TF as part of the combat trains or field trains. Further discussion of CSS support can be found in Chapter 8.

## HASTY ATTACK

The hasty attack is conducted either as a result of a meeting engagement or when a bypass has not been authorized and the enemy force is in a vulnerable position. Hasty attacks are initiated and controlled with FRAGOs and are usually indicated when a movement to contact results in enemy contact. Figure 6-10 shows a light armor hasty attack.

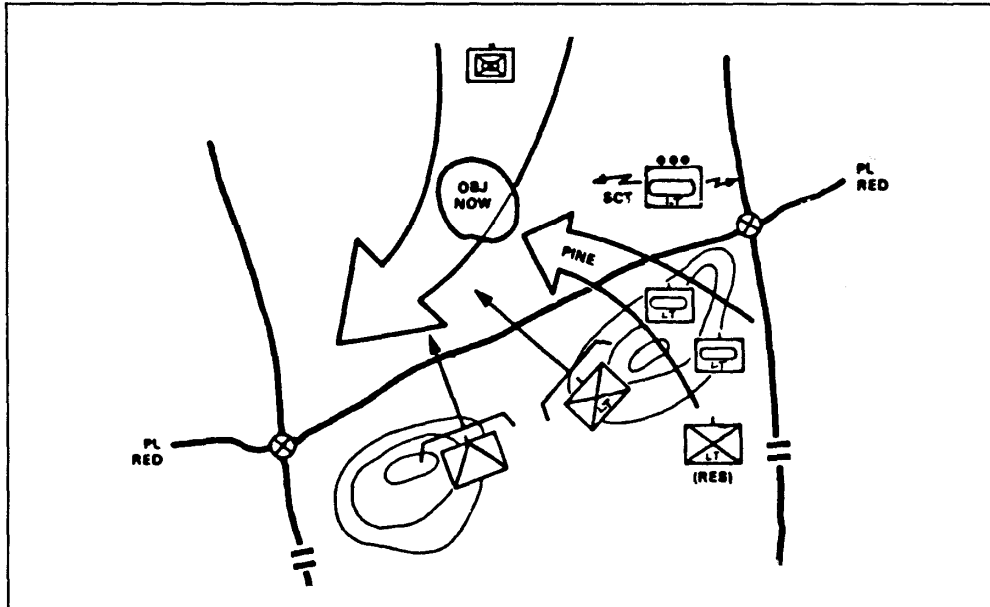

Figure 6-10. Light armor task force in a hasty attack.

## FM 17-18

Hasty attacks at the TF level are conducted as described in FM 71-2, with the following planning considerations:

- Commanders must carefully consider where and when to dismount the infantry to maximize its effectiveness. The infantry should be transported as close to the battle as possible before dismounting, taking security into consideration. M8s cannot fight with infantry riding on top of them; however, M8s are vulnerable to enemy dismounted forces if they outrun their own supporting infantry. Light armor is most effective when working as a team with its light infantry. That team must be preserved during maneuver.
- Antitank-equipped HMMWVs are best deployed in overwatch. During hasty attacks, the maneuverability and survivability of the M8s should be maximized with the less maneuverable and survivable TOW HMMWVs in overwatch.

## DELIBERATE ATTACK

TF deliberate attacks differ from the hasty attack in that they are characterized by precise planning based on detailed information, thorough preparation, and rehearsals. Deliberate attacks normally include large volumes of supporting fires, main and supporting attacks, and deception measures.

A light armor battalion TF will usually be the division's main attack element against an enemy force consisting of mechanized forces. Figures 6-11 and 6-12 illustrate light armor deliberate attacks in breaching and assault operations.

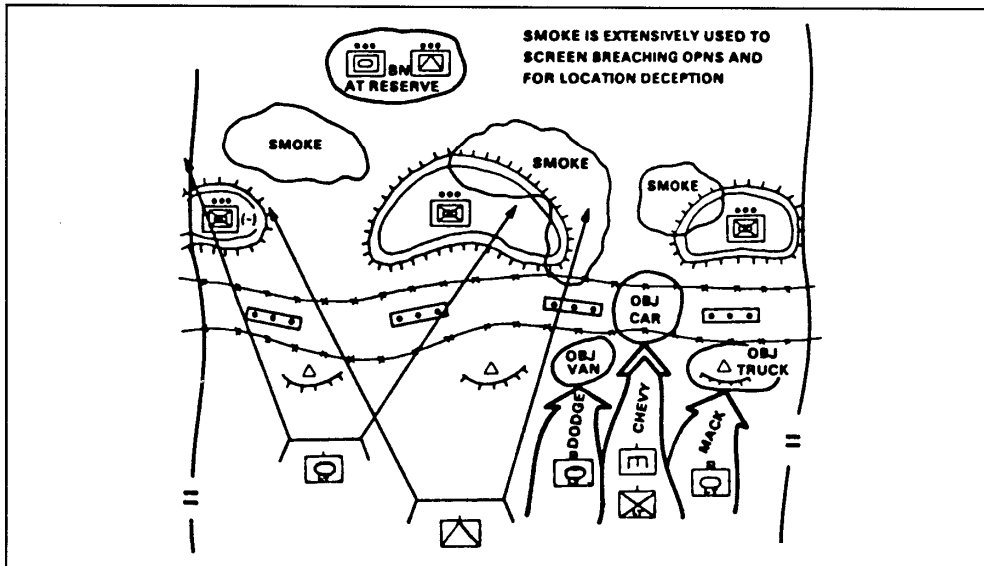

Figure 6-11. Light armor task force deliberate attack (breach).

Planners should consider the following factors:

- The timing of the attack must be synchronized with the other elements of the division. The rest of the division may be moving dismounted or truck-mounted and planners must consider the rate of movement based on terrain and weather.
- The division possesses limited mechanical obstacle breaching systems. The breaching of obstacles will in most cases be conducted manually with dismounted engineers or with the aid of light dozers or SEEs, requiring suppression from M8s and smoke for protection and concealment. Obstacle breaching therefore requires extensive planning and rehearsals.
- The division's organic artillery consists of towed 105-mm howitzers and may be augmented with corps-level towed 155-mm howitzers if force buildup has matured to the level in which corps systems have entered the theater. Light forces also rely on CAS and naval gunfire (NGF) for FS.

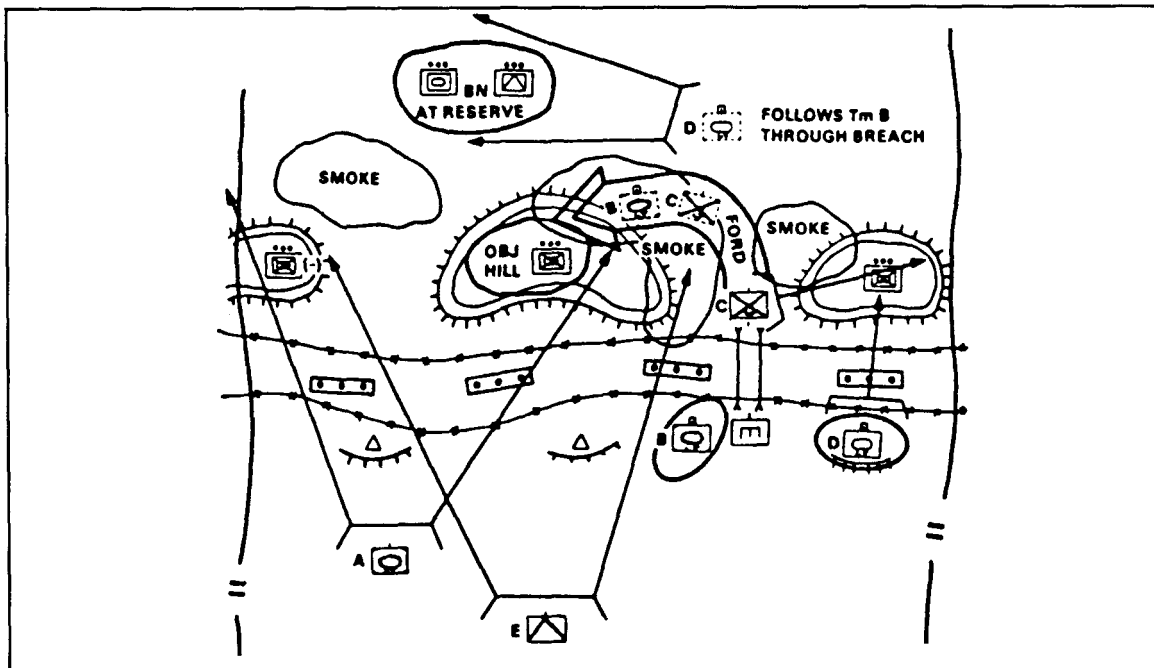

Figure 6-12. Light armor task force deliberate attack (assault).

## EXPLOITATION

The exploitation is conducted to take advantage of success. It prevents the enemy from reconstituting an organized defense or conducting an orderly withdrawal. It may follow any successful attack. The keys to successful exploitation are speed in execution and pressure on the enemy. Exploitations are usually oriented on a terrain objective containing enemy's reserves, CS, CSS, and C2 facilities.

The light armor battalion is the light division commander's exploitation force. It is the most mobile ground element and can regain and maintain contact with the withdrawing enemy force. Planners must prepare for support during exploitation, with considerations for refueling and rearming. Air resupply may be used to support the force during exploitation.

## PURSUIT

The pursuit normally follows a successful exploitation. It differs from an exploitation in that a pursuit is oriented primarily on the enemy force rather than on terrain objectives. While a terrain objective may be designated, the enemy force is the primary objective. The purpose of the pursuit is to overrun the enemy and destroy him.

If the enemy is predominantly dismounted, the division commander will probably use his infantry in the pursuit. The light armor TF may be designated as the division reserve during the pursuit of a dismounted enemy force; it may become the main effort if the fleeing enemy is mounted.

## RAID

A raid is an attack into enemy territory to accomplish a specific purpose, with no intention of gaining or holding terrain. Raids may be conducted to-

- Capture prisoners.
- Capture or destroy specific enemy material.
- Destroy logistical installations.
- Obtain information concerning enemy locations, dispositions, strength, intentions, or methods of operation.
- Disrupt enemy plans.

The light armor TF may conduct, or direct subordinate elements to conduct a raid. Raids may be conducted mounted or dismounted. A mounted raid is normally conducted as an exploitation with a limit of advance or as an attack with a limited-depth objective.

Raids may be conducted in daylight or darkness, within or beyond supporting distance of the parent unit. When the area to be raided is beyond supporting distance of friendly lines, the raiding party operates as a separate force. Raiding force security is vital because the raiding party is vulnerable to attack from all directions. Raids should be timed so that the raiding force arrives at the objective area at dawn, twilight, or other times of low visibility. FS, if in range, should be planned.

During movement in daylight, the raiding force uses covered and concealed routes of approach. During reduced visibility, advance and flank security detachments precede the raiding force. They prevent premature discovery of the raid by locating enemy security detachments and directing the raiding party around them.

The withdrawal is usually made over a different route from the approach. Security detachments are employed to ensure that the routes of withdrawal are open. Protective fires are planned along the axes of advance and withdrawal. Rally points are planned for units to assemble after they have completed the mission and are ready to withdraw.

Planning considerations for raids include the type and number of vehicles and weapons that the raiding force will have, movement distance, length of time the raiding party will operate in enemy territory, and expected enemy resistance. The raiding force usually carries everything required to sustain itself during the operation. Resupply of the raiding force, if required, is by aircraft. Figure 6-13 illustrates a raid with light armor.

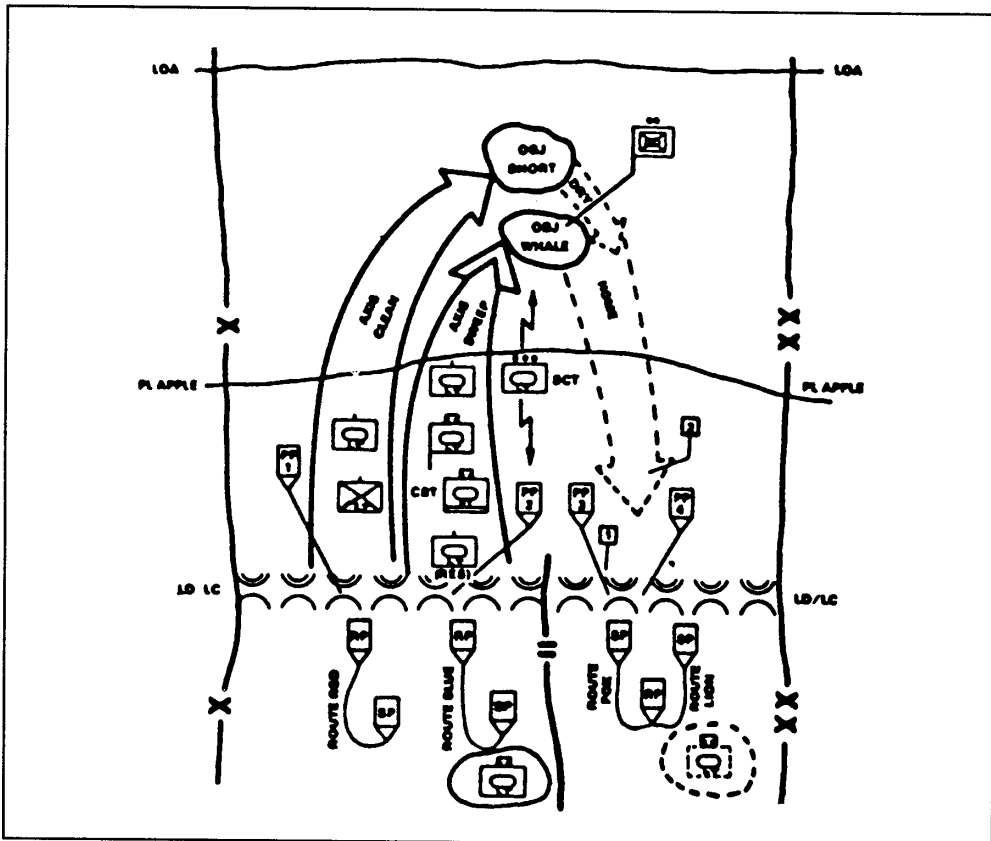

Figure 6-13. Raid with light armor.

## Section V. Defensive Operations

The light armor battalion conducts defensive operations as part of a LID defense. It can be integrated into the defense in the following ways:

- As the division's reserve or counterattack force.
- Defending in sector from BPs.
- Task organized with companies supporting each infantry brigade, and a reserve force under the control of the light armor battalion headquarters.
- As a security force.

The light armor TF defends in sectors or BPs or using a combination of both. Figure 6-14 summarizes the factors to consider when selecting BP or sector defense.



FACTOR	BATTLE POSITION	SECTOR
Avenues of approach	Well defined; enemy can be canalized	Multiple avenues prohibit concentration
Terrain	Dominates avenues of approach	Dominating terrain not available
Area of operations	Narrow	Wide
Mutual support between companies	Achievable	Cannot be achieved
Higher commander's ability to control	Good	Degraded

Figure 6-14. Factors in battle position and sector defenses.

### DEFEND IN SECTOR

METT-T may cause the division commander to deploy the battalion in a sector in which he expects enemy mechanized or armored forces to attack. Light armor company teams construct battle positions and defend in depth. Light infantry deploys in surrounding terrain that favors dismounted attacks and facilitates supporting fires. Figure 6-15 shows a defense in sector.

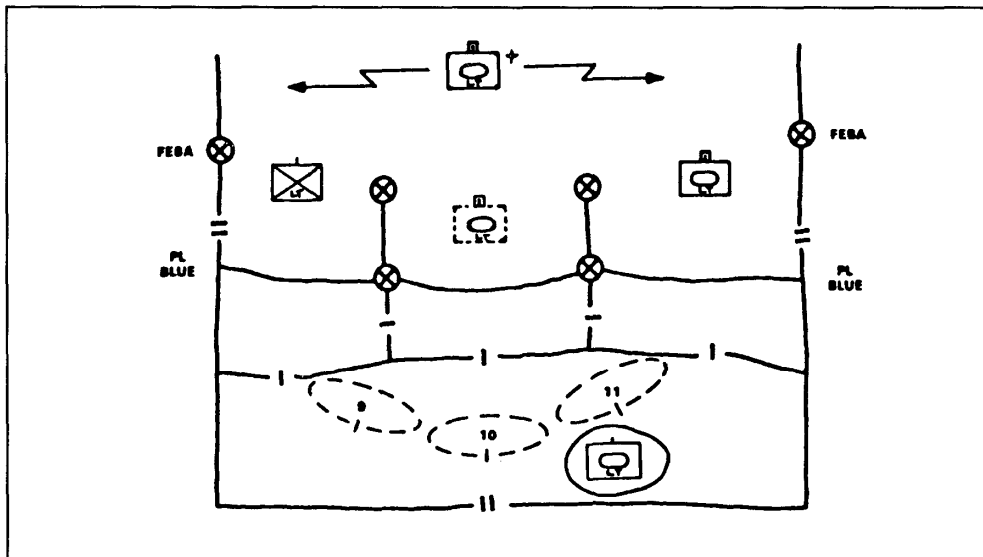

Figure 6-15. Battalion defending in sector.

## BATTLE POSITIONS

A BP is a general location and orientation of forces on the ground from which units defend. The BP can be used for units from battalion- to platoon-size. Light armor units defend BPs in the same way armored units do. The difference is that the light armor battalion will not normally operate in terrain that allows it to defend a battalion size BP. The BP defense for light armor units will usually consist of company BPs controlled by the TF. Security forces may operate forward and to the flanks of BPs for early detection of the enemy. Figure 6-16 shows a BP defense.

Units can maneuver in and outside of the BP as necessary to adjust fires or to seize opportunities for offensive action in compliance with the commander's intent. The commander may freely move his force within the assigned BP. The commander must notify the higher commander and coordinate with adjacent commanders when maneuvering his force outside the BP.

The TF commander allocates space to the subordinate elements within the general area. The TF commander-

- Selects subordinate BPs by considering space two levels down (platoon level). He provides sufficient space in each BP to allow for dispersed primary and alternate positions. Room for operations in limited visibility, supplementary hide positions, and locations for combat trains are also considered.
- Varies the degree of maneuver of teams by allocating larger company BPs. BPs may also be placed in depth.

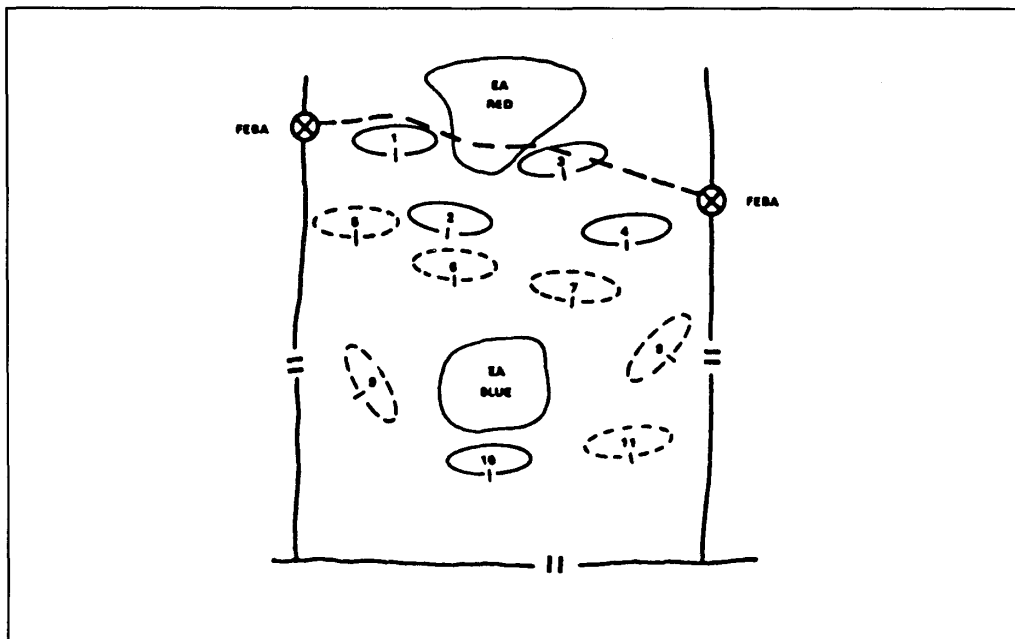

Figure 6-16. Battle position defense.

## OTHER DEFENSIVE TASKS

**Reserve.** In some cases, each infantry brigade may be task organized with a light armor company to strengthen the brigade defense. Platoons within the companies may be further attached to infantry battalions. Chapter 4 discusses how a platoon would fight as part of a battalion TF. Chapter 5 discusses how a company would support a brigade. In these cases, the battalion headquarters may become the controlling headquarters for the division reserve consisting of at least one light armor company and other divisional combat forces. This option provides the division commander with a responsive, flexible, potent maneuver force that he can use anywhere in the area of operations. The division can commit the reserve during the battle to spoil the enemy's attack, destroy him, or reinforce success and gain the initiative.

**Rear Operations.** The battalion can provide rear area security for the division. Force buildup may mature to a point in which heavy armor or mechanized follow-on forces enter the theater and assume responsibility for the area of operations once covered by the light infantry division. The division may then assume a corps reserve role, or prepare for future offensive operations. Within the division, the light armor battalion may be tasked to react to rear area threats. The battalion executes this mission similar to a counterattack mission in reaction to forces inserted into the rear area.

**Attacks From a Defensive Posture.** Attacks from a defensive posture include counter-attack and spoiling attacks as part of either hasty or deliberate operations. The light armor battalion is an ideal force for the division commander to use for this mission. The following considerations apply:

- **Counterattack.** Light infantry defensive operations against a mechanized or armored threat employ defensive positions in depth, coupled with EAs to reduce and then destroy the enemy force as it moves through the AO. The infantry is basically fixed in position once deployed into a defense. The light armor battalion provides a mobile force that can move throughout the defensive sector and counterattack to defeat the enemy force at the decisive place and time. The counterattack is usually a key element in a coordinated effort to mass fires-CAS, attack aviation, artillery, and other fires-into a designated EA. Light armor TFs attack by fire or by fire and movement.
- **Spoiling attack.** The spoiling attack strikes the enemy when he is most vulnerable during preparations for attack in AAs or attack positions or on the move before crossing his LD. The objective of the spoiling attack is the enemy force, not terrain. The reserve is often used in a spoiling attack to allow forward units to concentrate on defensive preparations.

## Section VI. Other Operations

### RETROGRADE

Retrograde operations consist of three missions: delay, withdrawal, and retirement. Light armor units execute these missions in the same manner as armored units. See Chapter 4 for a more detailed explanation.

The light armor TF provides the LID with the only asset capable of delaying against a mounted threat. The light armor TF is also well suited to act as the security force or DLIC when withdrawing either under enemy pressure or not under enemy pressure.

## RECONNAISSANCE IN FORCE

A reconnaissance in force is a deliberate attack to discover and test enemy disposition, composition, and strength. It is ordered by a division or higher commander.

Light divisions will usually face a light enemy force. In most cases, light infantry is best suited to finding and testing a similar enemy force. The stealth with which light infantry moves is an advantage when conducting any reconnaissance.

A reconnaissance in force mission could lead to a general engagement under unfavorable conditions that will commit the force executing the mission. Light infantry can be extricated more easily than a light armor battalion; therefore, commanders must weigh the advantages and disadvantages of using the light armor battalion as the reconnaissance in force unit. The light armor battalion may be given the mission of reconnaissance in force if the division commander desires a highly maneuverable force to find and test an enemy that may consist of armored or mechanized vehicles.

## COUNTERRECONNAISSANCE

Counterreconnaissance is defined as the sum of the actions taken at all echelons throughout the depth of the area of operations to counter enemy reconnaissance efforts. Counterreconnaissance is both active and passive; it includes all combat actions designed to deny the enemy information about friendly units by detecting, fixing, and destroying enemy reconnaissance elements (active measures) and by concealing friendly information through OPSEC (passive measures, see pages 2-22 through 2-24). An analysis of battles throughout history shows the initial stages of battle are mainly a fight for information. Both sides try to learn as much as possible about each other without committing their main effort or disclosing their primary positions. The force that wins the battle for information has a major advantage in the following battle.

**Planning and Preparation.** Counterreconnaissance is one aspect of security. The counterreconnaissance force commander is given specific tasks, such as “destroy” or “deny,” rather than the general task “conduct counterreconnaissance.” Even though the focus of the following discussion is in the defensive forward security zone, counterreconnaissance continues throughout all offensive and defensive operations. It is more than just a forward or flank security mission. All maneuver units must also plan to counter enemy reconnaissance elements that try to penetrate their area of operation. All elements, including CPs, CS, and CSS units, must establish local security and use hide positions. In the defense, OPs with an ambush ability should cover obstacles, gaps between units, and avenues of approach. These efforts are coordinated through the S2/S3 to ensure full coverage and to avoid friendly force engagements. The S2 consolidates all counterreconnaissance efforts into the battalion R&S plan. In the security area, a detailed IPB discloses likely enemy reconnaissance actions, such as the most likely avenues of approach for mounted and dismounted enemy reconnaissance elements.

Unity of command is vital for the forces in the security area. For example, the commander of a light armor company conducting a screen or guard mission for the battalion should have control of all forces in the security zone, including scouts, GSRs, ADA assets, light infantry, engineers, mortars, and Army aviation. The commander receives a detailed order that specifies expected enemy reconnaissance measures and the actions required to

counteract them. The S2 recommends to the S3 the placement of the force for final approval by the commander. Additionally, the battalion TF commander and staff should—

- Develop NAIs and assign responsibilities for observation.
- Determine the limit of enemy advance (to prevent enemy observation of friendly positions).
- Provide for continuous surveillance (overcommitment of the counterreconnaissance force will weaken security).
- Use a combined arms approach to acquire and defeat enemy reconnaissance.
- Assign specific responsibilities for obstacle security.
- Develop a plan to withdraw forward security elements.

The counterreconnaissance force commander must plan enemy tracking and hand-off criteria (using sectors, TRPs, pre-planned targets) to gain and maintain contact with the enemy until he is destroyed, captured, blinded, or deceived (based upon the battalion TF commander's intent). The commander must also plan and disseminate engagement criteria, displacement criteria for all forces, and rehearse acquisition, engagement, and withdrawal procedures. Counterreconnaissance forces in the security zone consist of some or all of the elements listed in the following paragraphs.

**Scouts.** Scouts are finders, not killers. In counterreconnaissance operations they help locate and track enemy reconnaissance elements for destruction by light armor or infantry forces.

**Light Armor and Infantry.** Light armor conducts either a screen or guard while the infantry man OPs, establish ambushes, and conduct patrols. TOW and Dragon systems, AT-4s, and MK 19s can defeat thin-skinned enemy reconnaissance vehicles.

**Ground Surveillance Radar.** GSRs can help identify enemy reconnaissance units, especially during limited visibility. They monitor open terrain, high-speed avenues of approach, or defiles. The effectiveness of GSRs is improved by using overlapping sectors, the "flicker" on-off technique to avoid detection, and a well enforced sleep plan to ensure that GSR operators are alert. GSR positions are reconnoitered during daylight and occupied just before dark with a security force. Targets can be generally identified at 10 kilometers or less, and movement can be detected at much greater ranges. GSR NCOs are technical experts on the capabilities of their systems and should be included in the planning process.

**Aviation.** Observation and attack helicopters can greatly assist as part of a combined arms force in counterreconnaissance operations. OH-58Ds provide excellent day and night detection of enemy reconnaissance elements while AH-64s serve as the "killers." One employment method is the continuous attack technique. While one element is surveilling, the other two prepare to relieve the surveilling element as they remain in holding areas or the FARP. This technique allows continuous aviation support to the counterreconnaissance operation. In the planning phase, the airbattle captain provides input for specific missions, responsibilities, and reporting channels. The security plan should include contingencies in case aviation elements are unable to fly.

**Field Artillery.** Responsive FS is vital for a successful counterreconnaissance operation. Based on the IPB, the FSO should develop a flexible FS plan tailored to the commander's concept. He should ensure the plan is distributed to, and entirely understood by the counterreconnaissance commander. Indirect fire is required to the limit of the battalion's observation. A COLT team attached to the counterreconnaissance force can employ Copperhead FA munitions to selectively and surreptitiously destroy enemy reconnaissance vehicles with more precision, a requirement when indirect fires will impact near friendly

troops. In cases where FA is not readily available to the counterreconnaissance force, the mortar platoon deploys forward.

**Engineers.** Camouflaged, low-density nuisance minefield are highly effective in the counterreconnaissance fight. Such minefield maximize surprise, have minimum impact on MBA obstacle preparation, confuse the enemy, and provide early warning and identification of enemy approach. Off-road AT mines and dummy minefield may also be effective. Infantry must provide security for the engineers or emplace these obstacles if engineers are not available. Scouts can also emplace minefield, however it may impede their ability to provide continuous observation. Regardless of who emplaces them, all minefield should be overmatched and covered by direct and indirect fires.

**ADA.** Counterreconnaissance forces are especially vulnerable to enemy air attack. MANPADS and Avengers must be placed in positions to provide a complete protection for the entire force in the security zone.

**Execution.** There are four counterreconnaissance options in the defense:

- Place a company team forward in a screen or guard role with the scout platoon and other security zone assets attached. The company team commander directs the battle. The scouts acquire the targets and the company team destroys the enemy reconnaissance elements as they enter the EAs (see Figure 6-17).
- Place a light armor platoon OPCON to the scout platoon. The scout platoon leader directs the battle. Scouts acquire the targets while the light armor platoon destroys the enemy reconnaissance elements as they enter an EA.
- Designate a platoon or company team to provide a reaction force. The placement of the reaction force can either be in the MBA or in the security zone. The company team commander or scout platoon leader directs the battle. Scouts acquire the targets while the reaction force attacks to destroy the enemy reconnaissance.
- Require the scout platoon to destroy enemy reconnaissance elements. The scout platoon leader directs the battle. However, when scout elements become involved in a direct fire engagement, they quit observing their designated areas, and other enemy reconnaissance elements slip through.

Techniques may include—

- Tasking the scout platoon to conduct a zone reconnaissance to their designated OPs. They should assume enemy OPs are already in the zone.
- Tasking the infantry to conduct patrols and cover dismounted avenues. They can also help detect and destroy enemy OPs.
- Placing GSRs so friendly scouts and infantry patrols are not to their front, thus avoiding confusion by their movements.
- Deploying the scouts and OPs in depth—not on a line across the battalion front. They should have overlapping fields of observation so the forward OPs can visually hand over the advancing enemy reconnaissance to the next OP.
- Having a dedicated scout section observe each light armor platoon sector.
- Placing all elements in the security zone on the same radio net as the commander.
- Designating “no-movement areas” for specific times.
- Positioning selected CSS assets forward initially to reduce response time. Prestock as much as possible before moving into the security zone. Disseminate the location of the forward security area casualty collection point to everyone in that area and to these selected CSS assets.

**Displacement of the Counterreconnaissance Force.** Planning and executing the withdrawal of counterreconnaissance forces are critical. The withdrawal of the force should be planned as a rearward passage of lines under enemy pressure. Route recognition signals and timing for withdrawal must be coordinated and rehearsed between counterreconnaissance elements and company teams in the MBA. If possible, routes should go around friendly units rather than through them to avoid masking friendly fires. An effective displacement concealment technique is to fire linear indirect targets of HE/smoke forward of all friendly elements.

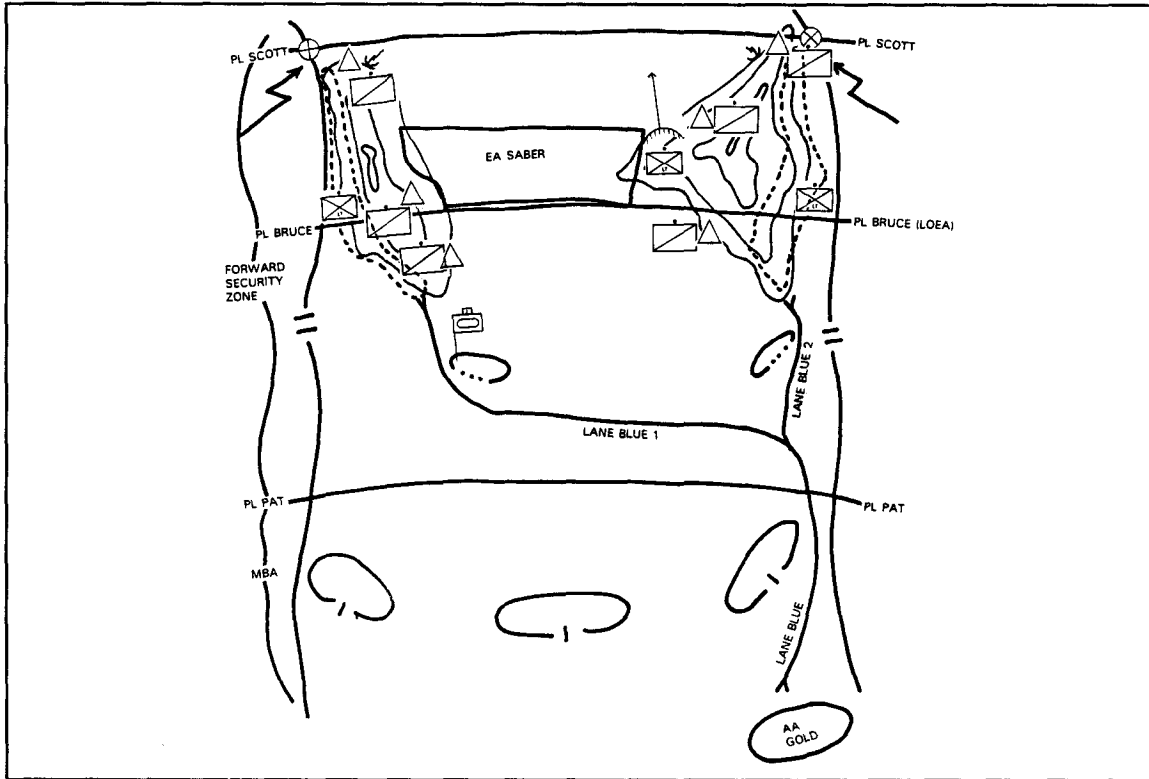

Figure 6-17. Example of a company/team conducting a forward screen with the scout platoon and other security zone assets attached.

## PASSAGE OF LINES

Passage of lines is an operation in which one unit moves through another unit that is stationary and disposed in a tactical formation on a FEBA. It may also occur when an exploiting force moves through a force that conducted the initial attack. Light infantry forces may conduct a passage of lines to get behind the enemy, especially during infiltrations or raids. Movement in forward unit areas must be controlled, coordinated, and kept to a minimum. This avoids conflict with friendly troops. Light forces treat the positions of forward units as danger areas. They must be assumed to be under enemy surveillance in all weather or visibility. Detailed reconnaissance and coordination are crucial to ensure that the passage is conducted quickly and smoothly. This is especially true when units are operating in small elements, such as during infiltrations and exfiltrations.

**Planning.** The battalion is particularly vulnerable during a passage of lines. Personnel and units may be overly concentrated; fires of the stationary unit may be temporarily masked; and the passing unit may not be well disposed to react to enemy action.

**Tentative Plan.** The commander of the passing unit makes a tentative plan for the conduct of the overall operation. The plan includes the following:

- Organization. Unit and team integrity is maintained to provide better C2.
- Order of movement. An order of movement is prescribed based upon the number of passage points, degree of security required, enemy situation, terrain, and the formation the battalion will be traveling in after the passage. An order of movement reduces confusion and congestion by setting priorities on who moves and when.
- Security. The scout platoon can assist in the passage of lines by screening between the enemy and the battalion to provide early warning and limited protection. Noise, light, and radio discipline must be enforced.
- C2. The technique of C2 depends on the number of passage points. Ideally, multiple passage points are established, a tactic which favors decentralized control. The battalion commander must decide how he can influence the action and position himself accordingly. For example, if the battalion is conducting a passage of lines to attack forward of the FEBA, the commander will probably follow the lead unit.

**Transfer of Responsibility.** The time or circumstances when responsibility for the zone of action or sector of defense is transferred must be mutually agreed upon by the two commanders. The commander of an attacking battalion assumes responsibility for the zone of action when he has at least a company and a control element forward of the stationary unit. The responsibility for a sector changes from the commander of the disengaging unit to the commander on the defensive or delay position when the disengaging unit passes a specific location (a designated phase line, called the battle handover line) or at a specified time. Coordination and control are facilitated if the boundaries of the passing unit and the stationary unit coincide.

**Control Measures.** Control measures that can be incorporated into a passage of lines include the following:

- Assembly areas. These are areas in which a force prepares or regroups for further action. They are selected so as not to interfere with friendly forward positions.
- Attack position. This is the last position an attacking force may occupy before crossing the LD.
- Passage lanes. These are lanes along which a passing unit moves to avoid stationary units and obstacles. Planning should provide for primary and alternate lanes.
- Passage point. This is the point where units will pass through one another, either in an advance or a withdrawal. It is located where the commander desires subordinate units to physically execute a passage of lines.
- Time of passage. The specific time may be set by the commander ordering the passage.
- Recognition signals. These are used to send messages. Signals may consist of one or more letters, words, visual displays, characters, signal flags, or special sounds with prearranged meaning whereby individuals and units can be identified.



- **Contact point.** This is a point at which two or more units are required to make physical contact.
- **Release point.** This is a clearly defined control point on a route where specified units revert to the control of their respective commanders. Each of these elements continues its movement toward its own destination.
- **Route.** This is a line of travel from a specific point of origin to a specific destination.

**Fire Support.** FS planning is an essential element of a successful passage of lines. Direct and indirect fires of the stationary unit are normally integrated into the FS plan of the passing unit. Assets and control means may be collocated to provide coordinated and responsive support.

**Reconnaissance.** A thorough reconnaissance covers routes to, through, and beyond the area of passage. It should include existing troop locations and proposed positions. Care must be taken not to compromise unit intentions; therefore, it may be necessary to limit the number and size of reconnaissance parties. It may be better to use the vehicles or aircraft of the stationary unit.

**Liaison.** Liaison involves the exchange of information that is necessary for the conduct of the passage of lines. This includes the following:

- Designation of units to pass.
- Mission of units and scheme of maneuver.
- Fire support.
- Enemy situation.
- Friendly locations (for day and for night):
  - Contact and coordination points.
  - OPs and patrol routes.
  - PPs and lanes.
  - Obstacle locations and types.
  - AAs or attack position.
  - CS and CSS locations for emergency support.
  - Routes.
  - SOI information.

**Conducting a Passage of Lines.** Once the plan is formulated, the battalion commander will direct a thorough reconnaissance. If the passage of Lines is forward of friendly elements, the reconnaissance should include the route to the RP, the AA, and the passage lanes to the PPs. Normally, AAs will be occupied, at which time a reconnaissance by key leaders is made of the passage lane and PPs. The battalion commander may want to use the scouts to reconnoiter and screen forward of the passage points to provide early warning while the battalion conducts the passage of lines. Coordination is made with the stationary force. Recognition signals must be mutually agreed upon, and SOI information must be exchanged. Emergency signals must be agreed upon so that the passing and stationary units understand them.

Questions that should be asked and mutually answered include the following:

- Can the stationary unit provide guides?
- What FS is available?
- What CSS can be provided (such as litter teams)?
- What actions occur if enemy contact is made?

Once reconnaissance and coordination are completed, the battalion plan is finalized and disseminated to the lowest level. Just before the passage of lines occurs, a passing unit representative conducts last-minute coordination with stationary elements. This coordination should include—

- Confirmation of SOI and emergency signals.
- Any changes in friendly unit locations or obstacles.
- Any new enemy activity.
- The number of personnel and equipment to pass through the passage point.

At a prearranged time, movement toward passage lane begins. To increase speed and reduce vulnerability, multiple lanes are used consistent with the passing unit's scheme of maneuver, available routes, and needs of the stationary force. Marches are carefully calculated so that units arrive at passage lanes at the correct time, with few or no halts en route. At a location short of the PP, the recognition signal is identified, and a guide links up with the passing unit. The guide taking the passing unit through the PP leads it through friendly obstacles to an RP. The passing unit representative who conducted the last-minute coordination may position himself at the PP to identify vehicles and troops as they move through the PP. If necessary, challenges are made to ascertain whether units know the correct password. Command groups of both units may be collocated at a point from which they can observe critical areas, make timely decisions, and issue instructions to ensure the uninterrupted movement of subordinate units.

## RELIEF IN PLACE

In a relief in place operation, one unit is replaced in combat by another unit. It may be accomplished during offensive or defensive operations, preferably during periods of limited visibility. A relief in place is conducted when a unit needs to reconstitute, rest, or decontaminate. Units that have a change of mission may also require relief.

The primary purpose for the relief is to maintain the combat effectiveness of committed elements. A relief in place may be conducted to—

- Replace a combat-ineffective force.
- Relieve a unit that has conducted prolonged operations.
- Replace a unit that requires medical treatment or decontamination as a result of exposure to nuclear, biological, or chemical munitions.

Relief in place requires extensive planning. Security, secrecy, and speed are critical. Incoming and outgoing commanders must coordinate—

- Exchange of liaison personnel down to company level.
- Positions of weapons.
- Exchange of sketch cards, range cards, and tactical and fire plans.

## FM 17-18

- Relief of organic FS elements.
- Location and transfer of responsibility for obstacles.
- Guides and routes into and out of positions.
- Transfer of excess ammunition, wire lines, POL, and other materiel to the incoming unit.
- Communications.
- Joint reconnaissance of operational area.
- A deception plan.
- Routes for both units that facilitate speed of operation.
- Procedures for maintaining CS and CSS from the unit being relieved until line units have been relieved and the relieving units are prepared to support their operation.
- Enemy situation and intelligence.
- Sequence of relief.
- Time of change of responsibility for the area.

The tactical situation dictates whether the relief will be conducted during the day or at night. Before the relief operation, the incoming unit moves to a preplanned AA behind the unit to be relieved. The incoming command group sets up near the outgoing CP.

Units conduct the relief of forward positions using one of the following techniques:

- The relieving companies occupy hide positions and move into the primary positions after the relieved elements begin to withdraw to subsequent positions.
- The relieving companies occupy alternate positions as the relieved units withdraw from primary positions. This relief procedure is initiated when speed is desired.
- During periods of limited visibility, relieving companies move into primary positions before the relieved companies withdraw. Once primary positions have been occupied, the relieved units withdraw.

During the relief, both units are on the ongoing unit's radio net. The outgoing unit maintains its previous level of radio traffic. The incoming unit maintains listening silence. When relief is complete, the incoming unit switches to its assigned frequency.

**COMBAT SUPPORT**

This chapter describes the organization, capabilities, and employment considerations of CS elements in the LID that may be provided to or operate in close proximity to light armor forces. It will also discuss the CS organizations organic to the light armor battalion. When light armor elements are task organized to light infantry TFs, CS will come as part of the normal infantry battalion or brigade. In some instances the infantry headquarters may task organize CS units to a light armor company team. In other instances the LID may task organize CS elements to the light armor battalion when it operates as a battalion TF.

CONTENTS		Page
Section I. Indirect Fire Support . . . . .		7-2
Organization . . . . .		7-3
Fire Support Planning and Execution . . . . .		7-3
Company Fire Support . . . . .		7-10
Field Artillery . . . . .		7-13
Characteristics . . . . .		7-15
Mortars . . . . .		7-16
Naval Gunfire . . . . .		7-20
Section II. Tactical Air Support . . . . .		7-23
US Air Force Tactical Air Support. . . . .		7-23
Planning Close Air Support . . . . .		7-23
US Navy/Marine Corps Tactical Air Support . . . . .		7-31
Section III. Army Aviation Support.. . . .		7-32
Organization . . . . .		7-32
Characteristics . . . . .		7-32
Employment . . . . .		7-32
Section IV. Air Defense Support . . . . .		7-34
Organization . . . . .		7-34
Characteristics . . . . .		7-35
Employment . . . . .		7-35
Section V. Engineer Support . . . . .		7-37
Organization, Characteristics, and Capabilities. . . . .		7-37
Employment . . . . .		7-39
Command and Control . . . . .		7-40
Operations . . . . .		7-40

CONTENTS (Cont)

	Page
Section VI. Nuclear, Biological, and Chemical Support . . . . .	7-41
Organization, Characteristics, and Capabilities . . . . .	7-41
Employment and Operations . . . . .	7-42

## Section I. Indirect Fire Support

FS is the collective and coordinated use of indirect-fire weapons, armed aircraft, and other lethal and nonlethal means in support of a battle plan. Lethal FS includes mortars, field artillery (FA), air-delivered weapons (discussed in sections II and III), NGF, and ADA used in its secondary role. Nonlethal means include illumination, smoke, and EW. The force commander employs these means to support his scheme of maneuver, to mass firepower, and to delay, disrupt, or destroy enemy forces in depth. Indirect FS planning and coordination exists at all echelons of maneuver. This section will discuss indirect FS. The indirect FS system supporting light forces is the collective body of—

- Command, control, and coordination facilities and personnel.
- Target acquisition and battlefield surveillance.
- Indirect FS weapon systems.

An FA battalion is normally placed in DS of a light infantry brigade. The brigade commander will give priority of fires to selected maneuver elements during each phase of the battle based on his scheme of maneuver. The FS system supporting the light armor battalion TF consists of the same basic components as those that support a tank battalion. The light armor battalion has a dedicated FSE, but light armor elements are normally task organized and FA support usually received through the parent infantry TF.

Attack system assets are allocated to the light armor battalion as priorities of FS based on the division or TF commander’s guidance and scheme of maneuver. Besides indirect FS, attack system assets could include CAS and FASCAM.

The light armor maneuver commander uses FS to enhance his combat power by—

- Destroying, suppressing, and neutralizing targets.
- Obscuring the vision of enemy forces.
- Isolating enemy formations and positions.
- Slowing and canalizing enemy movements.
- Killing or disabling the enemy at ranges greater than direct-fire weapons capability.
- Screening with smoke or isolating areas with scatterable mines.
- Reducing the effect of enemy artillery by active counter fire.
- Interdicting follow-on threat echelons.

The maneuver commander must decide what effect FS must have on a particular target. The three target effects categories are—

- Destruction. Destruction puts a target out of action permanently. Direct hits are required to destroy hard material targets. Usually, destruction requires large expenditures of ammunition and is not considered economical. A casualty rate of 30 percent or more will normally render a unit ineffective.

- **Neutralization.** Neutralization temporarily knocks a target out of action. It does not require an extensive expenditure of ammunition and is the most practical type of mission. Most missions are neutralization fire. A casualty rate of 10 percent or more may neutralize a unit.
- **Suppression.** Suppression of a target limits the ability of enemy personnel in the target area to perform their jobs. The effects of these fires usually last only as long as the fires are continued. Suppression requires the least amount of ammunition; however, since its effects are not lasting, it is unsuitable for some targets.

To take advantage of the effects of FS, the light armor leader must know the planned target effect and synchronize his maneuver plan to maximize the M8's shock effect and firepower capabilities.

## ORGANIZATION

**Battalion FS Organization.** The battalion FSO is the fire support coordinator (FSCOORD) for the maneuver battalion. He is in charge of the FSE and is the principal FS advisor to the maneuver commander. The FSE, located with the operations element of the maneuver forces, may include—

- The FSO (captain).
- The FS plans/targeting officer (lieutenant).
- The FS sergeant (sergeant first class).
- The FS specialist (specialist).

When added to the FSE to perform their FS functions, other representatives serve as a functional FS team to enhance FS coordination. These representatives may include—

- S3 -Air.
- Mortar platoon leader.
- Battalion NBC officer.
- TACP.
- Supporting arms liaison team (SALT).
- Air defense officer.
- Other representatives (such as engineer, allied force, and Army aviation liaison personnel).

## FIRE SUPPORT PLANNING AND EXECUTION

FS planning procedures at the light battalion TF level are essentially the same as those in armored battalions. When the light armor battalion operates as a unit and priority of artillery fires is given to the battalion, the FSO must consider the following during planning:

- Assigned tactical mission of FA units.
- Number and caliber of artillery units in support.
- Range capabilities, including special munitions and rocket-assisted projectiles (RAP).

- Effects of available munitions and quantity on hand.
- Locations of primary and future positions.
- Size of the FPF.
- Radius of burst.
- Maximum and sustained rates of fire.
- Target acquisition for both external and organic internal assets.

**Planning Considerations.** Effective FS depends on centralized planning and decentralized execution and coordination. FS planning is a continuous process of analyzing, allocating, and scheduling. It determines how FS is used, what types of targets are attacked, when they are attacked, and with what means. The goal is to effectively integrate FS into battle plans to optimize combat power. To do this, FS planning is concurrent with battle planning. Planning must be flexible to accommodate the unexpected in combat and to facilitate rapid change. It anticipates factors like massing of FS assets, changes in force mission, realistic movement times, resupply, target acquisition, replacement of entire units, and technical support, including survey and meteorological requirements. The FSO must consider three vital sets of information: relationship of the commander's intent for maneuver and FS to other operating systems; factors of METT-T; and guidance from higher FA and maneuver headquarters. He must remember these factors cannot be considered individually. Each affects the others.

**Process.** FS planning begins with the commander's guidance and intent. It continues through the development of a prioritized list specifying what targets are to be attacked and when (decide), the acquisition of those high pay-off targets (detect), and the determination of attack options to be used (FS, maneuver, EW, or a combination) to defeat the target (deliver). It concludes with the assessment of the effects of the attack.

**Commander's Intent.** At each level, the FSO plans fires as the commander outlines his scheme of maneuver. The FSO must seek and understand the commander's guidance and intent and be prepared to make recommendations for the integration of available FS. He must know when and where the commander wants FS and what the commander wants in the way of effects, duration, and timing. To understand the commander's intent, he must also understand why and how unit direct fire assets are to be employed so he can supplement, not interfere with, their employment. Also, the FSO must ensure that he knows how FS is to be integrated with other operating systems and how to synchronize his plan to complement their employment. The FSO is responsible for informing the commander of all changes to the FS plan received through FS channels.

**METT-T.** Information is continuously analyzed at all levels of command considering the factors of METT-T (see Figure 7-1).

**Mission.**

- What is the mission?
- What is the commander's concept of the operation, scheme of maneuver, and concept for FS?
- What is the commander's intent?

Figure 7-1. Factors of METT-T.

- What is the objective of the operation?
- What route is the unit using?
- What are the intermediate objectives?
- What are the missions of higher, lower, and adjacent units?
- Are there any contingency missions?

**Enemy.**

- What are the enemy's capabilities and limitations in the unit zone of action (such as FS assets, direct-fire weapons, and vehicle mobility)?
- What are likely enemy COA?
- Where are known, suspected, and likely enemy locations?
- How does the enemy employ his forces (artillery, patrols, FOs, attack helicopters)?

**Terrain and weather.**

NOTE: This category includes observation, cover and concealment, obstacles, key terrain, and avenues of approach (OCOKA), as well as weather.

- What is the best use of terrain reinforcement as a combat multiplier?
- What is observation like in sector?
- Are cover and concealment available in sector?
- Where are obstacles (man-made and natural) in sector?
- Where is the key terrain?
- Where are likely positions for ambushes, LPs/OPs, and EAs?
- Where are the assembly areas?
- What is the weather forecast, and how will it affect mobility and visibility?
- How does terrain affect mobility, both friendly and enemy?
- What kinds of munitions are best suited for the terrain and weather?
- Are appropriate FS coordination measures tied to terrain, when applicable?

**Troops available.**

- What is the status of FSO/FS cell training, experience, personnel, and equipment?
- What FS assets are available, and what are their locations and capabilities?
- What is the status of the supported unit?
- What is the status of the observers in sector (such as FOs, combat observation lasing team [COLT], and scouts)?

Figure 7-1. Factors of METT-T (Cont).



**Time available.**

- How long before the operation begins?
- How much time is available to develop a fire plan?
- How long will it take to coordinate the fire plan?
- How long is the operation expected to last?

Figure 7-1. Factors of METT-T (Cont).

**Guidance from Higher Headquarters.** Higher headquarters will give the FSO information essential to the FS plan, including—

- The commander's intent at that level.
- FS assets available.
- FS coordinating measures.
- Target lists.
- Schedules of fires.
- Technical advice on FS matters.
- Constraints on FA Class V controlled supply rates (CSR).

**Fire Planning and the Decision-making Process.** The decision-making process is as detailed, or as simple, as time permits. The commander plays the central role in this process, with the staff providing advice and information related to their respective areas. The process is primarily downward, beginning at higher echelons and progressing downward to the company FSO. Its effectiveness requires continuous interaction and bottom-up feedback.

When the maneuver commander receives his mission and issues his initial planning guidance, the corresponding FSO receives guidance from the higher FSO. As a minimum, this guidance should cover the following:

- FS asset allocation and status.
- Commander's target attack guidance.
- Fires planned by higher headquarters in your zone.

**Deliberate Fire Planning.** Deliberate fire planning is conducted through a formal top-down process, with bottom-up refinement as time permits. It starts at all levels immediately upon receipt of the mission. Its foundation is the military decision-making process based on detailed interaction with other staff members. The decide-detect-deliver methodology assists in the development of a fire plan that is integrated and supports the scheme of maneuver. The battalion FSO should not wait for a target list from higher headquarters before beginning his own planning. He is responsible for identifying the battalion FS requirement with the commander, operations officer, and primary and special staff. He does this by receiving the fire plan and targets from the brigade FSO, modifying targets as necessary, and recommending targets of concern to the battalion commander. Using the target list worksheet and overlays as tools, he forwards his list of targets to subordinate FSOs.

The company FSO and company commander plan targets to support the company scheme of maneuver. From the battalion, the company FSO receives targets that are within the company area of interest. He modifies them as necessary and adds any other targets as according to the maneuver commander's priorities. Modifications and additions are submitted through the battalion to the brigade FSO for inclusion in the final brigade target list and fire plan.

At the lowest level, the company FSO nominates targets in his sector, records this target information on the target list work sheet, and forwards it to the battalion FSO. The battalion FSO considers the target information he receives from each of the company FSOs, consolidates it, adds targets needed by the battalion, and forwards a copy of the target list work sheet to the brigade FSO. The brigade FSO receives target lists from the battalion FSOs. Using a target overlay, he resolves duplications, adds targets developed by the brigade target acquisition assets, prioritizes the list, and sends it to the DS battalion. He informs the battalion FSOs of any subsequent changes to the plans. Once targets are received by battalion and/or brigade FSOs, they prepare their fire plans and schedules to support the maneuver and allocate targets to the appropriate FS agency or asset.

**Quick Fire Planning.** The purpose of quick fire planning is to rapidly prepare and execute FS in anticipation of an impending operation. It is the brigade FSO's responsibility to ensure the DS battalion S3, FDC, and battalion FS cells understand the quick FS plan and how it is used. Quick fire planning techniques constitute an informal fire plan. In the quick fire plan, the FSO is responsible for identifying targets to be engaged in the target list, allocating all FS assets available to engage the targets in the plan, preparing the schedule of fires, and disseminating the schedule to all appropriate FS agencies for execution. The following steps are used in the quick FS planning sequence:

- Receive the OPORD. The key is understanding what the commander wants. Obtain the following decisions from the commander:
  - Targets to be engaged.
  - Desired effects on targets.
  - Order and timing of target engagement.
  - Duration of fires.
  - H-hour.
  - Priority of fires.
  - Priority of targetting.
  - Priority of execution.
  - Other FS assets available.
  - Time check from commander.
  - Estimated rate of movement.
  - Need for target adjustment.
  - Concept of the operation, including objective and defensive positions; maneuver control measures; and obstacles.
- Find out what assets are available for the operation. Concurrently, send a WO to all attack agencies. These may include the FA battalion S3, mortar platoon leader, air liaison officer (ALO), naval gunfire liaison officer (NGLO), SALT-Air, and aviation LO (if any are applicable).

- Obtain from the FA DS battalion the firing units that will be designated to fire in the quick fire plan schedule.
- Obtain from the maneuver commander availability of the mortar platoon (company FSO to battalion FSO for mortars in a company operation) for inclusion as firing units in the schedule of fires.
- Obtain tactical air (TACAIR) mission information from the FS cell. Coordinate CAS requirements with the ALO (such as aircraft type, ordnance, time on station, laser codes, and control procedures).
- Obtain the availability of naval aircraft and/or NGF from the firepower control team, SALT-Air, or NGLO.
- Plan targets in accordance with the scheme of maneuver, commander's guidance, and allocated assets, determining—
  - Assets to be used.
  - Munitions mix.
  - Shell/fuze combinations.
  - Duration of fire for each target.
  - Time to fire.
- After receiving the commander's approval, disseminate the fire plan to attack systems, higher headquarters FSE, and those who will implement the plan (FOs and subordinate FS teams). Whenever possible, send DA Form 5368-R (Quick Fire Plan) to the FA battalion CP and mortar platoon leader.
- Ensure that subordinate FSOs and FISTs understand the fire plan. As a minimum, cover—
  - Positions/locations of FSOs and FOs during the conduct of the operation.
  - Who is to initiate the fire plan or the fire request for specific on-call targets within the fire plan. The plan should include the agency to be contacted, when the target is to be initiated, and the communications net to be used.
  - Which unit has priority of fires and what the priority targets are, if applicable.
  - The use of methods of control in modifying the plan should it become necessary during execution.
  - The agencies that are available when additional targets of opportunity arise during execution of the plan.
- Inform the commander when the plan is ready. Review the plan and modify it as necessary. If time allows, conduct a rehearsal to ensure comprehension of the plan.

**FS Planning and Execution Matrix.** The FS planning and execution matrix is a concise, easy planning tool that shows the many factors of a complicated FS plan. It can help the FSO and the commander to understand how the fire plan supports the scheme of maneuver. It is a valuable planning tool for both the offense and the defense. It explains what aspects of the FS plan each FSO and FO is responsible for and at what phase during the battle these aspects apply. When approved, the matrix becomes the primary execution tool. It is set up with the maneuver elements along the left side and different phases of the mission (PLs,

events, or times) along the top. Phases should correspond to phases established on maneuver execution matrixes (see Figure 7-2). At battalion level, the following considerations apply:

- If priority of any indirect FS means is allocated to a team, it is indicated by an abbreviation of that FS asset in the upper left corner of the appropriate matrix box.
- If an FPF has been allocated, the abbreviation FPF, preceded by the type of indirect fire means responsible for firing the FPF, will appear in the center of the box.
- If a priority target is allocated to a team, it will appear in the box as a priority target (PRI TGT), preceded by the means of FS responsible for firing the target. Once a target is determined as the PRI TGT, the corresponding target number is placed in the box.
- If a company FSO is responsible for initiating specific fires, the target number, group, or series will be listed in the box for that FSO. Specific guidelines concerning the target not included on the target list work sheet will be included in the box.
- If an airspace coordination area (ACA) is to be put in effect by a particular FSO, the abbreviation ACA, followed by the area code word designated for that ACA, will be shown in the box. The time the CAS or attack helicopters are due in the area is also listed.
- Other factors that apply to certain teams during a specific time frame may also be included in the appropriate box. General guidance is issued in the written portion of the OPORD.

	AA	CP 7	LD/LC	PL RED	PL BLUE	PL GREEN
TEAM TANK	FA FPF	FA PRI TGT CB 3002	FA PRI TGT GROUP C38		MORT SERIES FINISH	MORT MORT FPF
TEAM B	FA FPF	MORT B	MORT B MORT PRI TGT C83008	MORT MORT A PRI TGT C83125 MORT B PRI TGT C83225		FA FPF
TEAM C	MORT FPF	MORT A	MORT A MORT PRI TGT C83010	FA FA GROUP C68		FA FA FPF
TF CONTROL		FA GROUP C48 SERIES JOE	ACA ORANGE TGT 0800	ACA APPLE TGT 0815	FA GROUPS C78, C88, C98 ACA RAISIN TGT 0900	

Figure 7-2. Battalion fire support planning and execution matrix.

## COMPANY FIRE SUPPORT

**FIST Organization.** FIST personnel are the company FSO (lieutenant), FS sergeant (staff sergeant), FS specialist (specialist), and radiotelephone operator (private first class). In infantry companies, the FIST may contain FO parties, each with an FO (sergeant) and a radio operator (private first class). Armor companies have no platoon FOs. The FIST depends upon platoon leaders to assist in the execution of fires to support the plan.

**Company FSO.** The company FSO is the maneuver company FSCoord and integrates all fires to support the commander's scheme of maneuver. Although he is not the primary shooter for the company, the FSO must be an expert at locating targets and adjusting fires. His duties are to—

- Plan, coordinate, and execute FS.
- Advise the company commander on FS matters.
- Keep key personnel informed of pertinent information (such as spot reports and SITREPs).
- Train the FIST platoon leaders in applicable FS matters.
- Request, adjust, and direct all types of FS.
- Ensure the FS plan and matrix is disseminated to key personnel and that a FS rehearsal is conducted.
- Allocate FOs for surveillance of targets.
- Provide emergency control of CAS missions in the absence of qualified USAF personnel, such as the ALO, the enlisted terminal attack controller (ETAC), or the airborne forward air controller (AFAC).

**FS Sergeant.** The company FS sergeant is the senior enlisted assistant to the company FSO. He acts as the FSO when required. He is responsible for the supervision and training of all enlisted section members and the maintenance and employment of their equipment. The company FS sergeant must be able to perform all duties of the FSO.

**Company FSO Relationships.** The company FSO works closely with the company commander, who is ultimately responsible for FS. The company FSO gives recommendations and advice to the commander on all FS matters; therefore, he is the maneuver unit expert. Final decisions regarding company FS rest with the company commander. The company FSO goes with him to receive plans and orders. The FSO must understand the scheme of maneuver as well as the company commander does. On the basis of the commander's guidance and war-gaming, the FSO devises his FS plan, which must be presented to the commander for his approval.

Company FSOs work for the battalion FSO. The battalion FSO provides guidance, battlefield intelligence, information on FS assets, FS coordination measures, and technical advice to the company. The battalion FSO coordinates and clears FIST fire missions that fall outside company boundaries of the requesting company FIST. Company FSOs provide updated friendly and enemy battlefield information to the battalion FSO. This information includes the forward line of own troops (FLOT) location, SITREPs, spot reports, other essential elements of friendly information (EEFI), and information relating to PIR. The battalion FSO helps the battalion commander train company FSOs.

The company FSO should locate himself where he can best support the company. Since the MS has a three-man crew, the company FSO will operate from the commander's

HMMWV when necessary. Maneuver companies should have an SOP specifying where the FSO will locate in the company headquarters during tactical operations.

As company FSCoord, the FSO obtains the following information from the battalion FSO:

- Status and location of FS delivery systems that the company may use.
- Status of TACAIR missions and TACP CAS control personnel (ALO/ETAC/AFAC).
- Existing targets, scheduled fires, and known points.
- FS coordination measures in effect.
- Verified frequencies and call signs.
- Status of COLTs, if available.
- Availability of position location assets, position azimuth determining system (PADS), or survey to accurately find minefield or obstacles.

The FSO obtains a mission briefing from the company commander, including—

- The scheme of maneuver and commander's intent.
- Location of platoons, crew-served weapons, and listening posts/observation posts (LP/OP).
- Current enemy situation.
- Status and location of obstacles.
- Location of FPF.
- MOPP level.
- Air defense status.

As a minimum, the FSO provides the following information at the company order briefing:

- FS plan for the operation, including responsibilities for its execution.
- Existing targets, scheduled fires, and known points.
- FS coordination measures for the operation.
- Status of priority fires.
- FS assets available to support the operation, with their location and status.
- Verified frequencies and call signs.
- Availability of position location assets.
- Status of FIST personnel and equipment (including Classes I, III, and V supplies).

The FSO ensures that communications are established with FS assets, such as artillery and mortars; with FOs, including COLTs, if applicable; with the battalion FSO; and with the maneuver commander.

**Company FS Planning.** Planning at the lowest level in the deliberate fire process, company level, begins with receipt of the TF order. The order contains the FS annex, which includes the higher headquarters' targets in the TF sector, targets added by the TF commander to support his plans, and specific guidance for employment of mortars. Company

commanders are responsible for positioning primary observers, establishing secondary or backup observers, and establishing trigger points for calls for fire. Key personnel must understand their priority of fires within the TF, TF priorities within the brigade, and when and under what conditions priorities will change. Targets are planned according to the planning allocation provided in the TF order. The TF FSE provides at least one high-quality acetate target overlay to each company so that planning can begin immediately upon receipt.

At first glance, planning responsibilities at company level might appear to be slight. This is not the case. It is at this point in the planning process that the requirement for detail is most critical. Assisted by target area survey, if necessary, company FSOs must ensure that the actual grid to target and the trigger point are visible to the observer or will be visible given the expected conditions of smoke, night operations, or position within the formation during offensive operations. Each observer must understand the communications plan as well as the backup plan in case the primary observer is unable to complete the mission. All members of the FS team, platoon leaders, and key NCOs must be drilled on all aspects of the plan.

At the lowest level, the company FSO nominates targets in his sector, records target information on the target list work sheet, and forwards it to the battalion FSO. The battalion FSO evaluates target information from the company FSOs, consolidates it (eliminating duplication, for example), adds targets needed by the battalion, and forwards a copy to the DS battalion fire direction center (FDC) and the brigade FS cell. The brigade FSO receives targets from the battalion FSOs. Using a target overlay, he resolves duplications, adds targets developed by brigade target acquisition assets, prioritizes the list, and transmits it to the DS battalion. He informs the battalion FSOs if there are any subsequent changes to their plans and transmits the brigade target list. When targets are received at battalion or brigade, FSOs at those levels prepare their fire plans and schedules to support the maneuver and allocate each target to its appropriate FS agency or asset.

**Company Level FS Execution Matrix.** The company level FS execution matrix shown in Figure 7-3 includes the following information:

- Priorities of indirect FS to a platoon are indicated by an abbreviation of that FS asset and recorded in the upper left corner of the appropriate matrix box.
- The abbreviation PPF, preceded by the type of indirect fire means responsible for firing the PPF, is in the center of the box.
- PRI TGTs allocated to a platoon are recorded in the box as PRI TGT, preceded by the means of FS responsible for engaging the target and followed by the target number.
- If FIST elements are responsible for initiating specific fires, the target number, group, or series designation is listed in the box for that FIST element. Specific guidelines concerning fires not included on the target list work sheet will be included in this box.
- FS coordination measures to be in effect, followed by a word designated for that measure, are shown in the box. For ACAs, the time that planned CAS or attack helicopters are due on station is listed.
- Other factors that apply to a certain platoon during a specific time frame may be included in the appropriate box. General guidance is issued in the written portion of the OPORD.

	AA	LD/LC	PL WELLINGTON	PL JACKIE	OBJECTIVE
1st PLT	105FPF		MORT PRI TGT AC1212		3
2d PLT	105FPF	MORT	X		2
3d PLT			FA PRI TGT AC1234	Series PIANO	1
	A	B	C	D	E

Figure 7-3. Company level fire support execution matrix.

## FIELD ARTILLERY

The FA mission is to destroy, neutralize, or suppress the enemy by cannon, rocket, and missile fire and to help integrate all FS into combined arms operations. Normally, one FA battalion is in DS of a maneuver brigade. However, more artillery battalions can be assigned the mission to reinforce the DS battalion.

**Advantages.** The advantages of FA are that it—

- Adds depth to the battlefield. The FA can strike and destroy the enemy in depth before he can influence the battle.
- Offers various ammunition and fuze combinations.
- Gives continuous fire in all weather conditions, day or night, and from all types of terrain.
- Shifts and masses fires quickly.
- Is as mobile as maneuver forces. Artillery for LID, airborne, and air assault divisions is towed.

**Disadvantages.** The disadvantages of FA are that it—

- Is an area fire weapon. In some cases, however, point targets can be destroyed by using guided or homing FA projectiles. These projectiles are expensive and limited in quantity. They must be used only against high-payoff targets.
- Has a limited ability to survive enemy ground, air, and artillery attacks. Weapons can be detected because of their large signature from communications and firing. Therefore, artillery must displace periodically.



- Is not well suited for use in direct fire mode.
- Has limited ability to bring timely and accurate massed fires on moving targets without detailed coordination and planning.
- Must be observed fire to be effective.

**Organization.** The division commander normally places at least one FA battalion in DS of a committed maneuver brigade. Additional FA units may reinforce DS battalions and/or provide GS reinforcing fires to the brigade based on availability and priorities of the division battle. The organization of a DS FA battalion is shown in Figure 7-4.

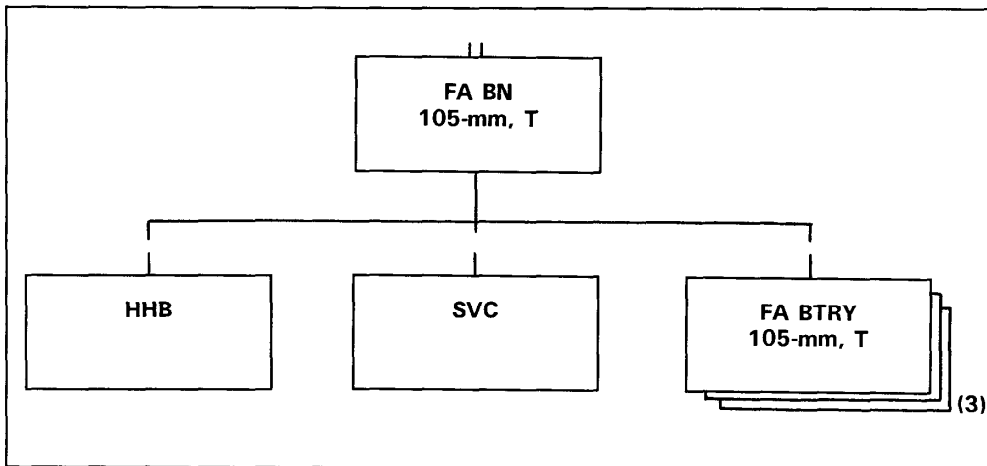

Figure 7-4. Direct support artillery battalion.

**Positioning.** The DS artillery battalion deploys and locates the main CP, combat trains, and each firing platoon and firing battery headquarters based on METT-T. Often these batteries will be in separate locations (split battery operation). The field trains normally operate in the BSA to increase its responsiveness. The following considerations apply:

- The maneuver commander must allocate sufficient position areas for all artillery units operating in his zone of action. Primary, alternate, and supplementary positions must be allocated throughout the zone for all units of the artillery battalion to synchronize their movement with the scheme of maneuver. The FA battalion commander is responsible for positioning his units, but he needs a general area and guidance from the brigade S3. Artillery units generally require firm ground, a good internal road network, defilade, cover, concealment, and defensibility. FA may not always operate with split batteries; often, a battery headquarters will be with a platoon.
- Depending on the tactical situation and terrain, an FA unit will move much like maneuver units. If enemy contact is not likely, it may move in column or wedge formation. If contact is probable, battery-size units will move independently, but movement will be coordinated so that one battalion or battery can provide FS to the maneuver force while another is on the road. Finally, if contact has occurred or is very likely, artillery units can move either by bounding or infiltration by battery, platoon, or individual gun.

## CHARACTERISTICS

The characteristics of US FA and mortars are in Table 7-1. The characteristics of US FA and mortar smoke are in Table 7-2. The characteristics of US FA and mortar flares are in Table 7-3.

Table 7-1. United States artillery and mortar capability.

TYPE WEAPON	MINIMUM RANGE (METERS)	HE MAXIMUM RANGE (METERS)	MAXIMUM RANGE RAP (METERS)	MAXIMUM FPF WIDTH (METERS)	WEIGHT (POUNDS)	RATE OF FIRE (ROUNDS/MINUTE)	
						MAXIMUM	SUSTAINED
60-mm mortar (lightweight) M224	70	3,500	NA	2 tubes 75 x 30	45	30	15
81-mm mortar M29A1	70	4,790	NA	140 x 40	96	20	8
81-mm mortar improved M252	80	5,600	NA	4 tubes 150 x 50	93	36	15
107-mm mortar HE M329A1	920	5,650	NA	120 x 40	672	18	3
HE M329A2	770	6,840		3 tubes			
120-mm mortar (M57, M68, M91, M933, M934, M929, M930)	200	7,200	NA	360	80	15	4
105-mm (M119)		14,000	15,100	210 x 35 btry	4,000	10 3 min	3 30 min
105-mm (M102)		11,500	15,100	210 x 35 btry	3,170	10 3 min	3
105-mm (M101A1)		11,000	14,500	210 x 35 btry	4,980	10 3 min	3
155-mm (M114A1/A2)		14,800	19,400	300 8 gun btry	12,700	4 3 min	1
155-mm SP (M114A1/A2/A3) (M109A6)		18,100	23,500	200 pltn 400 btry	53,900 (55,000 A2/A3)	4 3 min	1
155-mm (M198)		24,000	30,000	300 btry 8 gun	15,800	4 3 min	2 30 min
203-mm (M110A2)		22,800	30,000	240 pltn 480 btry	62,100	1.5 3 min	0.5
MLRS (M270)	8,000	30,000	NA	NA	54,800	12	(Rockets)

- NOTES: 1. Maximum and sustained rates can be maintained only for the number of minutes listed.  
 2. For charge 8, sustained rate is 1 round/minute for the first 60 minutes, 1 round/3 minute thereafter.  
 3. May vary; cannon tube has a thermal warning device.

Table 7-2. United States artillery and mortar smoke capability.

DELIVERY SYSTEM	TYPE ROUND	TIME TO BUILD EFFECTIVE SMOKE	AVERAGE BURNING TIME	AVERAGE OBSCURATION LENGTH (METERS PER ROUND)		
				WIND DIRECTION		
				Cross	Quartering	Head/Tail
155 mm	WP	1/2 min	1-1 1/2 min	150	75	50
	HC	1-1 1/2 min	4 min	350	250	75
105 mm	WP	1/2 min	1-1 1/2 min	75	60	50
	HC	1-1 1/2 min	3 min	250	175	50
107 mm	WP	1/2 min	1 min	200	80	40
81 mm	WP	1/2 min	1 min	100	60	40
60 mm	WP	1/2 min	1 min	75	60	40

**NOTE:** All rounds are fired as standard missions with parallel sheets under favorable conditions.

Table 7-3. United States artillery and mortar illumination capability.

TYPE	RATE OF DESCENT (FEET PER SECOND)	BURN TIME (SECONDS)	RATE OF CONTINUOUS ILLUMINATION (ROUNDS PER MINUTE)	AREA ILLUMINATED (METERS)	CANDLE-POWER
107-mm/ M335A2	12	80	2	1,500	850,000
105-mm/ M314	30	60	2	1,000	450,000
155-mm/ M485	18	180	1	2,000	1,000,000
81-mm/ M301	18	60	2	1,200	750,000
60-mm	19	25	4	800	250,000

## MORTARS

Mortars are the only organic indirect FS asset in the light armor organization. Mortars provide responsive high-angle fires that can kill the enemy, suppress enemy fires, and conceal the movement of friendly forces. Mortars are best suited for immediate suppression and smoke. Mortars are most lethal against enemy light infantry. For the light armor leader, mortars can be extremely beneficial when the M8's direct-fire weapon systems cannot engage enemy light infantry due to masking terrain. Mortars are extremely important in the FS plan, especially in operations other than war. The FSO's doctrinal responsibility is limited to recommending the integration of mortars into the FS plan. For considerations of mortar employment, refer to FM 7-90. The FSO is concerned with the following areas.

**Characteristics and Capabilities.** The light armor battalion mortar platoon consists of six M252 81-mm mortars (two sections with three mortars each). The mortars are ground-mounted and carried in an M998 HMMWV. When planning mortar fires, the FSO must consider the high rate of fire and ammunition availability. A mortar platoon can fire over 300 rounds in less than 5 minutes. As a result, the ammunition supply can be quickly exhausted.

**Command Relationships.** There may be situations when the mortar platoon cannot support all of the battalion while remaining under battalion control. This may occur when a maneuver unit is given a mission that separates it from its parent unit. In those situations, a platoon or section may be placed under OPCON or attached to the supported unit, based on the following considerations:

- **Priorities.** The commander may specify support by assigning priority of fires and/or PRI TGT(s) to a subordinate unit.
- **OPCON.** This gives a commander the authority to direct forces provided to him to accomplish specific missions, usually limited by function, time, or location. The commander controls the tactical employment, movement, and mission of the mortars. He is not responsible for A/L support.
- **Attachment.** This temporary relationship gives the commander receiving the attachment the same degree of C2 as he has over units organic to his command. The commander selects the general location of the attached mortar element and controls its deployment as well as its fires. He is also responsible for logistical support and security of the mortars. Attachment is appropriate when units are assigned independent missions.

**Tactical Employment.** The commander has three options when considering how to employ the battalion mortar platoon. It can be employed by platoon, section, or squad. Usually the mortar platoon is employed as a platoon in the defense and in sections or squads in the offense. Squads consist of one mortar and its crew. Squads can be grouped together into sections. Finally, the entire platoon may be employed together. Selected options are based on the commander's guidance, METT-T, and priority of fires. The FSO must be prepared to advise the commander on which option to use. When employing mortars, the FSO must consider the following:

- Mortars are best at employing smoke and illumination fires.
- Mortars are most effective against soft-skinned targets.
- Their high-angle trajectory makes mortars effective against targets that are masked or in defilade.
- High-angle fires are easily detected by enemy radars.
- High-angle fires are adversely affected by strong winds.
- Mortar positions are seldom surveyed, creating the need for more adjustments and a loss of surprise when attacking targets. This can be overcome by requesting FA survey support or ensuring each position has a global positioning system.
- Mortars are effective in built-up areas (BUAs).
- METT-T must be considered when employing mortars. General positioning guidelines are as follows:
  - In the offense, one-half to two-thirds of the maximum range should be in front of lead elements.
  - In the defense, one-third to one-half of the maximum range should be in front of the lead elements.

- Positions should be selected to minimize the number of moves required.
- The mortars must be able to displace rapidly and provide continuous support.

**Platoon Employment.** The platoon operates from one or two firing positions and fires as one unit. The best way to position the platoon is to place the platoon sections in two separate locations at least 300 meters apart. The actual distance is based on the terrain, the ability to cover the sector, and limits in C2. A platoon located in a single area enhances C2 and local security but is more vulnerable to enemy counterfire. Fire direction centers (FDC) are trained to mass fires from separate locations onto a single target.

**Section Employment.** This places each section as a separate firing unit. The mortar platoon is normally employed by section to cover wider frontages. Each section is positioned so it can provide fires within the zone of action of the supported maneuver element. When employed by section, each section has an FDC or a computer. Depending on the range to target and separation of sections, more than one section may be able to mass fires on the same target.

**Squad Employment.** This places one or more mortar squads on the battlefield as separate firing units. This is usually done to support special requirements, such as—

- One-mortar illumination missions.
- Roving mortar adjustments.
- Antiarmor ambushes.
- Support for a very wide front.
- The maneuver element being required to cover a large front.
- Rear combat operations to support critical installations.

**Displacement.** It is essential that mortars displace rapidly and maintain their flexibility to provide continuous FS. Based on the scheme of maneuver, the mortar platoon leader develops a displacement plan. This is a map overlay with initial positions, subsequent positions, routes between the positions, and any control measures in effect. The following are considerations for selecting displacement techniques.

- By platoon—
  - The need for speed outweighs the need for immediately available fires.
  - This method may be used when contact with the enemy is unlikely.
  - Accurate and timely response to a call for fire is sacrificed; therefore, greater reliance is placed on “hip shoots.”
  - C2 problems are minimal.
- By section—
  - Continuous, accurate fires are required.
  - Speed is essential.
  - C2 is more difficult.
  - This method is slower than displacement by platoon.

- By individual squad—
  - The need for continuous fire outweighs need for speed.
  - C2 is extremely difficult.
  - This the slowest displacement technique.

**Movement.** Two movement options are available: successive bounds and alternate bounds. Generally, alternate bounds are used when displacement is rapid to keep up with support elements. Successive bounds are used when the maneuver element movements are not so rapid. Normally, the mortar platoon leader controls the bounds; however, if the tactical situation demands the decision to move to be based on multiple maneuver units, the FSO in close coordination with the battalion S3, will control bounds. Movement is conducted as follows:

- Successive bounds. A portion of the platoon moves to the next position. After that portion is in position and ready to fire, the rest of the platoon moves to the same position.
- Alternate bounds. A portion of the platoon moves to the next position. After that portion is in position and ready to fire, the rest of the platoon moves to a different position. This method applies to both the offense and the defense.

**Integration of Mortars into the FS System.** Mortars are an important part of the FS system. Based on the commander's guidance, the FSO must maximize their effectiveness through planning, coordination, and integration into the FS system and battle plan, as described in the following discussion:

- Tasks. The following tasks are inherent in planning, coordinating, and integrating mortar fires into the plan:
  - Develop target lists and plan fires based on the commander's guidance, and develop attack criteria to support the BOS.
  - Allocate priorities of fires and FPF.
  - Develop FS coordination measures to facilitate target engagement and safeguard friendly personnel.
  - Update target lists, priorities, and planned fires; and send them to the mortar FDCs.
  - Update operational status, location, and ammunition status of tire units.
  - Keep the mortar platoon updated on the tactical situation; include it in the orders process.
- Fundamentals. The following basic considerations apply to mortar integration:
  - Mortar fires are usually effective at providing smoke (white phosphorus [WP]); illumination; area fire; antipersonnel fire; fire to force armor to button up; fire in BUAs; and intense FPF on dismounted enemy.
  - Mortars are generally not effective at providing the following types of fires; therefore, other FS means should be used if possible: point destruction missions; armor destruction; and missions against well-protected defensive positions. If mortars are used to accomplish these missions, ammunition expenditure will be prohibitive.

## NAVAL GUNFIRE

NGF provides large volumes of responsive, immediate and accurate FS to light armor and infantry forces operating on land- near coastal waters and to amphibious operations within their range. Normally, naval fires are controlled by an NGLO attached to the FSE for a specific operation.

**Organization.** NGF in any US Army unit is coordinated through the ANGLICO. The ANGLICO is a Marine organization that consists of three brigade air/NGF platoons organized and equipped to plan, request, coordinate, and control NGF and naval air. Figure 7-5 shows the organization of the ANGLICO. Each brigade has two SALTs that are normally attached to maneuver battalions. The SALT consists of two officers and six personnel, who become part of the unit's FSE. The SALT has two firepower control teams (FCT) which may be provided to maneuver companies to request, observe, and adjust naval FS. The SALT officers coordinate all NGF and supervise the activities of the FCTs. In addition, they advise the FSCoord on all matters pertaining to NGF employment.

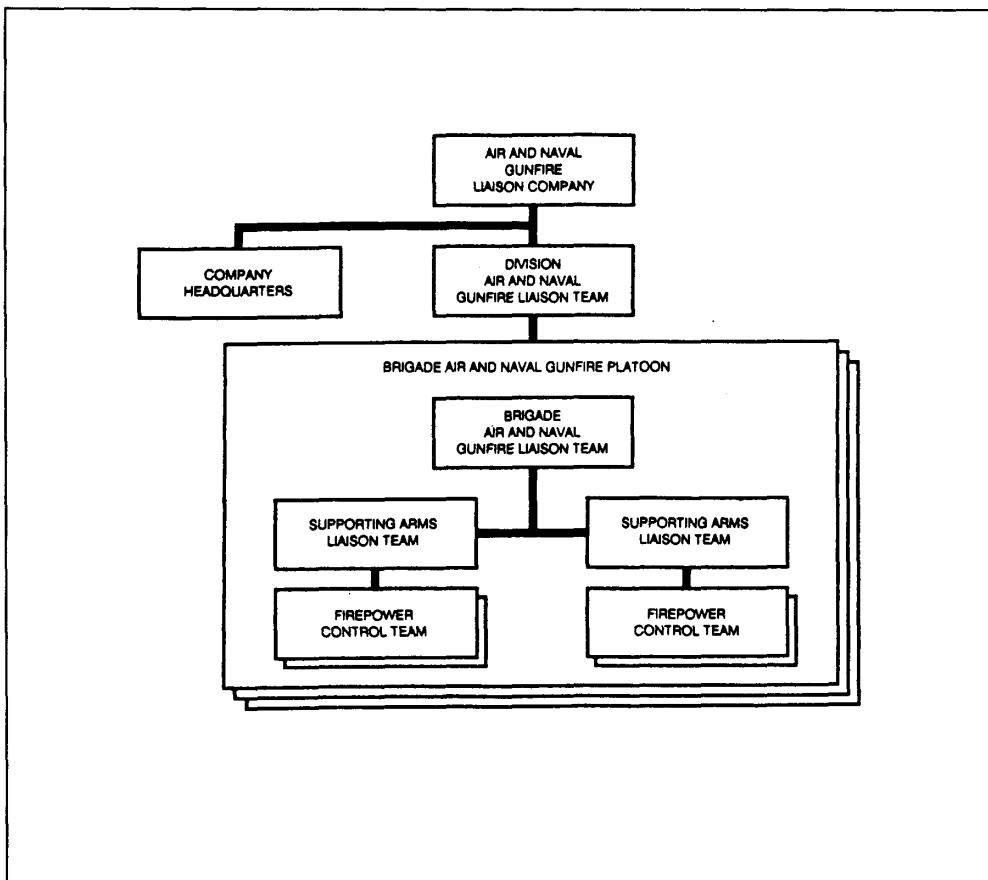

Figure 7-5. Air and naval gunfire liaison company organization.

**Coordination and Planning.** The NGF liaison team of the brigade operates on the division NGF support net high frequency (HF). This net provides communication between the division naval gunfire officer (NGO), the brigade NGLO and the ships in support of these units. This net is used for the day-to-day planning between units. Requests for FS are transmitted to the air and NGF team (at brigade or division), which forwards it to the ship. The NGO at division monitors and/or coordinates as necessary. This coordination is much the same as for FA engagement. When a light armor battalion or company is task organized to an infantry brigade, the SALT requests FS through the NGLO at brigade. When the light armor battalion operates separately, the SALT must contact the NGO at division. It does this using the FSO's communication means; the SALT does not have direct communication with the NGLO/NGO.

When NGF is available but ANGLICO personnel are not available, units may request NGF through the FS net to the division, where the NGO should be located with the division FSE. To increase response time for adjustments, Army personnel may interface with the NGF unit if the following equipment is available:

- NGF ground spotter net (frequency 2-30 MHz HF).
- Compatible equipment
  - Army: GRC-106, GRC-193.
  - USMC: PRC-104, GRC-193, MRC-138.
  - Air Force: PRC-104, MRC-107/108, GRC-206.

**Characteristics.** A complete understanding of the characteristics, capabilities, and limitations of NGF is essential to its successful use in ground support. Table 7-4 depicts the FS characteristics of naval ships used to support ground combat.

**Capabilities.** Capabilities of NGF include—

- The variety of munitions and fuzes, including HE and illumination, permits selection of optimum combinations for the attack of targets. Ammunition may also consist of precision-guided munitions.
- The high muzzle velocity and flat trajectory make the naval gun suitable for direct fire or assault fire, particularly against reinforced targets such as bunkers and hardened positions.
- Some naval guns have a very high rate of fire.
- The normal dispersion pattern is narrow in deflection and long in range. It permits effective coverage of such targets as roads and runways. Very close supporting fire can be delivered when the gun-target line is parallel to the FLOT.
- Precision fire control equipment permits accurate direct and indirect fires while the ship is under way or at anchor.

**Limitations.** Limitations of NGF include—

- The relatively flat trajectory results in a large range of probable error. The gun-target line in relation to the FLOT must always be considered. The FSO should avoid a gun-target line that passes toward or directly over friendly troops.
- Naval guns are less accurate in rough seas.
- The shore bombardment allowance varies with the ship type. When the need arises, remaining rounds will be held for self-defense.



- If a ship comes under attack, it may cancel its fire mission with the ground forces to counter the threat.
- The sole means of communication from ship to shore is HF AM radio, which is not compatible with standard Army FM radios.

Table 7-4. Fire support ships and their characteristics.

SHIP	GUN SIZE/CALIBER	RANGE (METERS) MAXIMUM/MINIMUM	RATE OF FIRE (ROUNDS PER MINUTE) MAXIMUM/SUSTAINED	AMMUNITION AVAILABLE
Battleship	16-inch/50 5-inch/38	35,909/910 15,700/910	2/1 22/15	HE, AP, ICM HE, WP, illum
Guided missile cruiser (CGN and CG)	5-inch/38 5-inch/54	15,700/910 22,999/910	22/15 40/20	HE, WP, illum HE, WP, illum
Guided missile destroyer (DDG)	5-inch/54	22,999/910	40/20	HE, WP, illum
Destroyer (DD)	5-inch/54	22,999/910	40/20	HE, WP, illum
Guided missile frigate (FFG)	5-inch/38	15,700/910	22/15	HE, WP, illum
Frigate (FF)	5-inch/38 5-inch/54	15,700/910 22,999/910	22/15 40/20	HE, WP, illum HE, WP, illum
Amphibious assault ship (LHA)	5-inch/54	22,999/910	40/20	HE, WP, illum
<b>LEGEND:</b>				
AP	= armor piercing	DDG	= guided missile destroyer	
CG	= guided missile cruiser	FF	= frigate	
CGN	= guided missile cruiser, nuclear	FFG	= guided missile frigate	
DD	= destroyer	LHA	= amphibious assault ship, general purpose	

NOTE: First-round danger close is 750 meters for all 5-inch munitions; 1,000 meters for 16-inch HE; and 2,000 meters for AP and ICM munitions.

**Employment.** Light armor units normally receive NGF support indirectly through the light infantry headquarters to which they are task organized. On occasion a light armor company, when operating pure or task organized as a team, will receive an FCT to request and adjust NGF. The light armor battalion will receive a SALT when it is organized as a TF. In some instances, when ANGLICO assets are limited, the battalion may only receive an FCT.

NGF ships are assigned the missions of DS or general support (GS) in much the same way as artillery is organized for combat:

- DS. A ship in DS usually supports a battalion. This ship can deliver both planned and on-call fires. On-call fires are normally requested and adjusted by the FCT of the supported unit or by an air spotter.
- GS. A ship is usually placed in GS of a brigade or division. The fires for the GS ship are conducted as directed by the NGO of the supported unit.

## Section II. Tactical Air Support

### US AIR FORCE TACTICAL AIR SUPPORT

TACAIR provided by the USAF consists of CAS, counterair (CA), air interdiction (AI), tactical airlift (TA), and tactical air reconnaissance. TA, AI, and CA are normally allocated at higher than brigade level. The following considerations apply:

- TACAIR reconnaissance is the acquisition of intelligence information using visual observation and/or sensors in aircraft.
- CAS is defined as air attack on hostile surface forces that are in close proximity to friendly troops. CAS can be employed to blunt an enemy attack, support the momentum of the ground attack, or provide cover for friendly movements. For best results while avoiding mutual interference or fratricide, aircraft are kept under “positive control” (part of the USAF’s TACAIR control system). The effectiveness of CAS is directly related to the degree of local air superiority attained. Until air superiority is achieved, competing demands for CAS and CA operations for available aircraft may limit sorties apportioned for the CAS role. CAS is the primary support given to committed brigades and battalions. Nomination of CAS targets is the responsibility of the commander, ALO, and S3 at each level.

The use of aircraft to support ground forces is subject to the following planning considerations:

- Air support is not available at all times. Even when planned, it may be diverted to a higher priority mission (immediate).
- Immediate requests may restrict indirect fires and will come with whatever ordnance has already been loaded-not necessarily the optimum weapon for a particular target.
- Air support may be limited by weather and enemy air defense systems.
- Support aircraft have varying capabilities to remain on station (loiter time).
- Target identification is difficult, so marking of enemy and friendly locations is required when in close contact.
- As long as the enemy has an effective air force, the emphasis will be on CA. As the battle progresses and the enemy’s air capability is reduced, the emphasis will shift to CAS.

### PLANNING CLOSE AIR SUPPORT

The battalion commander, aided by the S3, is responsible for planning fire and movement, just as he is in other FS planning. The following personnel are also involved in planning the use of TACAIR, particularly CAS.

**Battalion S3-Air.** The S3-Air receives, ranks, approves, and coordinates requests for planned CAS. He integrates CAS into the ground commander’s scheme of maneuver. He keeps the Air Force TACP advised on the current ground tactical situation, of the location of friendly units, and of any FS coordination and control measures established.

**Battalion FSO.** The battalion FSO is the full-time FSCoord for the battalion. He advises the battalion commander on all FS matters, including the use of CAS. He is also a focal point for CAS planning and coordination between the battalion commander, the S3-Air, and other interested parties. The FSO integrates CAS into the FS plan.

**Tactical Air Control Parties.** The USAF provides one TACP to each maneuver battalion. Each TACP includes an ALO, who performs FAC duties, and two TACAIR C2 specialists. One of the specialists is trained in terminal air control techniques and can perform TACP duties. The ALO supervises the activities of the TACP personnel; he advises the commander, FSO, and S3-Air on capabilities and limitations of TACAIR and other technical or tactical aspects of TACAIR missions as required. The ALO uses USAF TACAIR requests to maintain radio contact with all other TACPs in the division and with the air support operations center (ASOC). When possible, he provides final coordination of CAS missions in the battalion area. The TACP transmits to the ASOC all requests for immediate CAS. He advises the S3-Air and FSO of other units' immediate air requests. As changes in the TACAIR situation are transmitted over the TACAIR request net, the ALO relays them to the S3-Air and FSO.

TACP procedures in this manual conform to US Army and USAF standards. TACPs participating in allied operations should be familiar with the characteristics and attack profiles of all aircraft that may support ground operations.

**Preplanned Missions.** Preplanned missions are those for which a requirement can be foreseen. They permit detailed planning, integration, and coordination with the ground tactical plan. In the defense, CAS can be used to thicken fires in a decisive EA. In the offense, CAS can be planned to strike an anticipated enemy counterattack in the vicinity of an objective. Inherent in such preplanned CAS missions is the possibility that the target will not appear at the place and time that was expected. Such missions would then be released and used to fill requests for immediate CAS elsewhere on the battlefield. Preplanned CAS missions are most desirable because munitions can be tailored to the target and complete mission planning can be accomplished. Categories of planned CAS are—

- **Scheduled mission.** This is a CAS strike on a planned time on target (TOT), and will be included in the daily air tasking order (ATO).
- **Alert mission.** This is a CAS strike on a preplanned target area executed when requested by a supported unit. It is usually launched from a ground alert but may be flown from an airborne alert status. Alert (on-call) CAS allows the ground commander to designate a general target area within which targets may need to be attacked. The ground commander designates a conditional period within which he will later determine specific times for attacking the targets.

Requests for planned CAS missions originating at the light armor battalion level are forwarded to the brigade FSE over the 01 net or by any other means available. When the request is received by the FSE, it is reviewed by the G3-Air, the FSO, and the ALO. They determine the suitability of the targets for air attack and consider potential airspace conflicts. The FSO may decide that it would be better to use another weapon system against that target. As a minimum, he will integrate CAS into his FS plan. The G3-Air will then add the request to the tile for planned CAS missions, eliminate duplications, and assign target priorities. He then forwards the consolidated request to an assistant G3. Consolidated requests are coordinated with the division FSCoord and ALO. The requests are then forwarded to the corps G3-Air. Figure 7-6 depicts the planned CAS request net.

**Immediate Missions.** Immediate missions are executed in response to requests from supported ground maneuver commanders to fulfill urgent requirements that could not be foreseen. Details of such missions are normally coordinated while the aircraft are in the air.

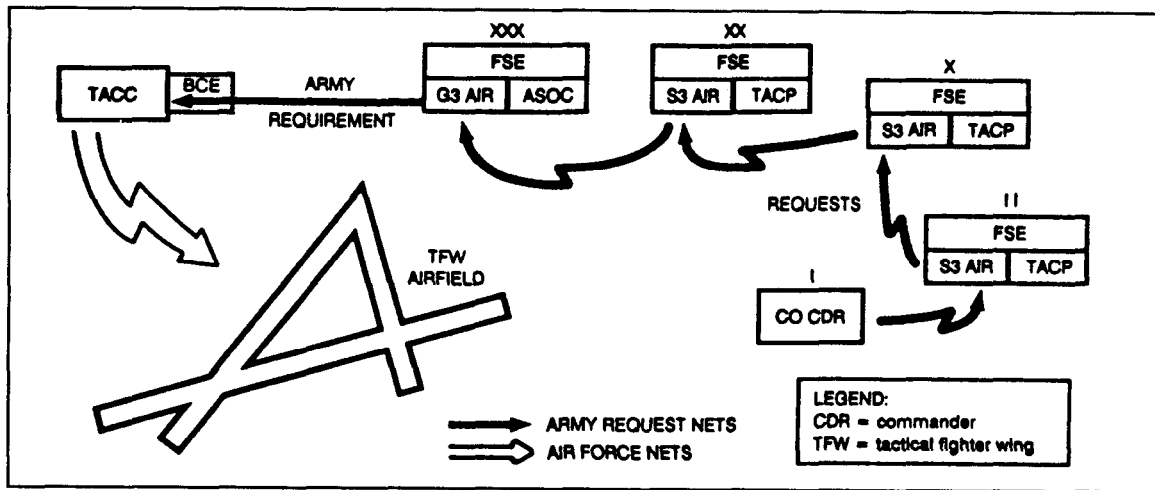

Figure 7-6. Planned close air support request channels.

Immediate mission requests are normally processed through USAF channels. Before requesting immediate CAS, the following points should be considered:

- Target type. CAS is most effective when attacking exposed and/or moving enemy forces and air defense assets.
- Enemy air defenses. Both anti-aircraft artillery (AAA) and surface-to-air missiles (SAM) are systems that may require suppression before CAS can be effective.
- Target acquisition. Well-camouflaged or small, stationary targets are difficult for pilots to acquire. These kinds of targets will require some kind of marking for identification. The use of an FSE or COLT to laser-designate a target can help target acquisition.
- Day or night observation. For night missions, the FSO should give special attention to target identification and the use of artillery to illuminate the target.
- Time available. Response and station time for CAS aircraft can vary from a few minutes to more than an hour. The TACP will normally have the most up-to-date information.

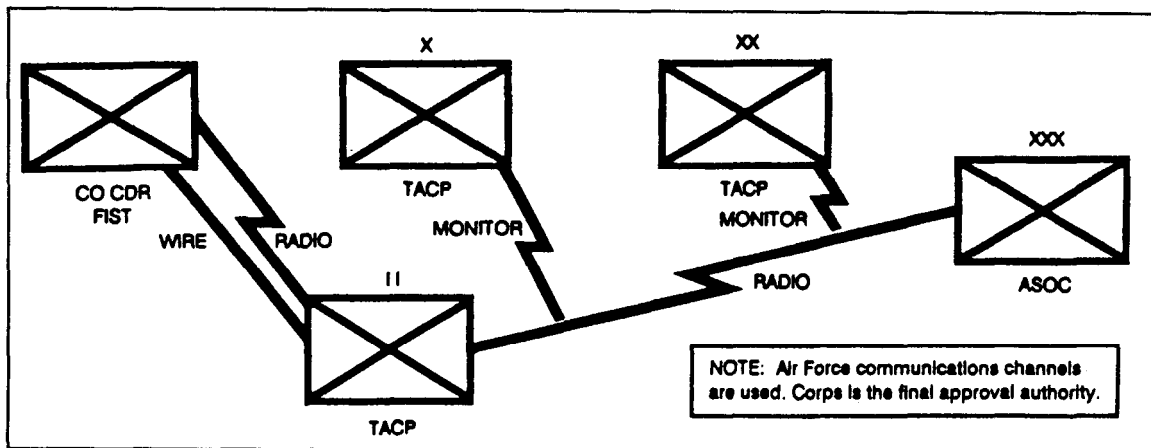

Figure 7-7. Immediate close air support request channels.

Requests for immediate CAS missions that originate at maneuver company level are forwarded to the battalion FSE and to the ALO (see Figure 7-7). Based on direction from the S3 and FSO, the ALO can make the request through the TACAIR request net from the TACP directly to the ASOC. The TACP at each level monitors the request and acknowledges receipt. Silence by an intermediate TACP indicates approval of the request by the associated Army echelon. If any echelon above the requesting echelon disapproves the request, the TACP at that echelon notifies the ASOC and the initiating TACP, giving the reason for disapproval. When the request is approved, the ASOC orders the mission flow. Immediate missions involve launching general alert aircraft using air alert sorties and/or diverting aircraft from other missions. Figure 7-8 depicts a typical immediate CAS request flow.

Before CAS aircraft release ordnance on the target, the TACP and FSO must accomplish several tasks. Radio frequencies and laser designation settings used by the FSOs, COLTs, and tactical aircraft should be predetermined and forwarded to all parties. Since most aircraft do not have FM radios, the ALO will use the ultrahigh frequency (UHF) tactical air direction net to communicate with CAS aircraft. Most USAF FM capability is nonsecure; therefore, it is critical that proper authentication procedures be used when FM radios are employed.

Following approval of the CAS request, the TACP and tactical air controller (TAC-A) receive aircraft mission data from the ASOC. These data include mission number, aircraft call sign, number and type of aircraft, ordnance carried, and TOT. The TACP determines any additional essential information, such as updated enemy locations and identification means, availability of fires for suppression of enemy air defense (SEAD), friendly ADA considerations, and time factors for the attack. If CAS aircraft are fitted with LSTs, the laser setting must be passed to the attack aircraft. When aircraft arrive at the target area, the TACP provides the pilots with updated information. They must be given enough information to positively identify the target. The TACP is also prepared to abort the attack if the safety of friendly troops is threatened. During the entire attack, the ALO watches for enemy surface-to-air fires and warns the aircraft accordingly.

If the CAS aircraft are fitted with LSTs, the TACP coordinates with the FSO or COLT to ensure that the targets are accurately marked for the aircraft. The LST-equipped aircraft detects the reflected laser, locks onto it, and illuminates an aiming cue in the pilot's head-up display. Even with laser designators, the use of marking smoke should be considered to help the pilot aim his LST accurately. Caution should be used to avoid laser-to-target visibility and attenuation problems caused by the smoke.

**CAS Planning Considerations.** CAS mission success is directly related to thorough mission planning based on the factors discussed in the following paragraphs.

**Weather.** Does the weather favor the use of aircraft? What is the forecast for the immediate future? Weather is one of the most important considerations when visually employing weapons; it can hinder target identification and degrade weapon accuracy.

**Target Acquisition.** Targets that are well camouflaged, small and stationary, or masked by hills or other natural terrain are difficult to identify from fast-moving aircraft. The use of marking rounds can enhance target identification and help ensure first-pass success. Moving targets will usually highlight themselves.

**Target Identification.** This is critical if CAS aircraft are to avoid attacking friendly forces by mistake. It can be accomplished by providing a precise description of the target in relation to terrain features easily visible from the air. Smoke, laser target marking, or other means can also be used.

**Identification of Friendly Forces.** Safe means of friendly position identification include mirror flashes, marker panels, and direction and distance from prominent land features or target marks.



General Ordnance Characteristics. What types of targets are to be engaged, and what are the desired weapon effects?

Final Attack Heading. Choice of the final attack heading depends upon considerations of troop safety, aircraft survivability, and optimum weapon effects. Missiles and bombs are effective from any angle. Cannons, however, are more effective against the sides and rears of armored vehicles.

Troop Safety. This is a key consideration in using CAS. The primary cause of fratricide is misidentification of friendly troops as enemy forces.

SEAD. SEAD will be required based on the capabilities of the aircraft and presence of enemy air defense systems in the target area.

CAS and Artillery Integration. Army artillery and tactical airpower are complementary. Because artillery support is more continuous and responds faster than CAS, CAS missions must be integrated with artillery so that limited firing restrictions are imposed. The ACA is the FS coordination measure used to accomplish this integration. There are four standard ACAs: lateral, altitude, timed, and altitude and lateral separation.

Other planning factors that must be considered are time available for planning, C3 and terrain. Refer to FM 6-20-50 for these additional planning factors.

**Strike Execution.** As the CAS aircraft reach the general vicinity of the target, they fly to a contact point that is normally given to the pilots through USAF channels. At the contact point, the pilots change radio frequencies and come up on the supported ground unit's TACP frequency. The pilots are then given a situation update by either a TAC-A or the ALO as they continue flying in the direction of the target. The CAS aircraft then fly to a reference point on the ground that the pilots can identify from the air, called the initial point (IP). When the CAS flight leader is cleared to attack, he switches to the attack frequency, contacts the TACP, and reports when his flight departs the IP and is en route to the target. This radio call is used to coordinate any required SEAD and/or target marking rounds.

It is important to remember that this entire procedure, in a high-intensity, high-threat environment, would have to be done as smoothly and quickly as possible. If the attack aircraft are not aligned with the correct target or if friendly troops may be endangered, the TACP must abort the attack. The CAS abort procedure uses a challenge and reply response. The CAS flight leader gives the TACP the two-letter challenge code; the reply "letter" from the TACP is the abort-call "code word." The reply letter should be transmitted after the words "ABORT, ABORT, ABORT." This procedure is possible only if the TACP or ALO has the same authentication system as the aircraft.

An effective daytime technique of marking target areas is to fire a mortar smoke round into the target area. Pilots can easily verify the target area prior to releasing ordnance. During limited visibility, the same technique can be used only using illumination rounds set for ground burst.

**Night Planning and Operation Considerations.** In a high-intensity, high-threat environment, the capabilities of CAS aircraft employed at night are very limited. To improve the capabilities of night CAS, the USAF is acquiring additional night-capable systems such as the low-altitude navigation and targeting infrared for night (LANTIRN) system. Despite the limitations, CAS aircraft still have a few advantages while attacking at night. The most important advantage is the limitation darkness imposes on enemy optically-sighted and infrared (IR) antiaircraft systems. This is particularly true if they do not have NVD. Airborne or ground-based illumination can also degrade enemy night-vision capabilities.

The two most important requirements of a night CAS operation are identification of the enemy or target and positive marking of friendly unit locations. The ground maneuver commander should rely on his own Army assets to accomplish the marking and illumination

requirement. Although flares released from airborne FACs, other CAS aircraft, or “flare ships” can effectively illuminate target areas, illumination fired by ground artillery and heavy mortars are normally preferred due to the continuous capabilities of sustained indirect fire. Fixed-wing aircraft that can conduct night CAS missions with battlefield illumination are the AV-8B, A-10, A-7, F-16, F-4, F-111, and F/A-18.

Laser designation capabilities of the A-10, A-7, AV-8B, and F/A-18 enable these aircraft to acquire targets without use of conventional illumination. The LSTs carried by these aircraft detect the reflected laser, lock onto it, and provide the data directly to the pilot. The F-4, F-16, F/A-18 and A-7 can also use radar to provide reference information for night operations. In addition, small radar reflectors, optimized for particular airborne radars, can create spotting cues for CAS aircraft.

Marking friendly unit locations improves joint air attack team (JAAT) and CAS safety and also provides target area references. Tracers and radar beacons can serve both purposes. If safe separation is a factor, friendly unit marking is critical. Fired into the air, 40-mm illumination grenades and flares are effective, but they may be useful to the enemy as well. Flares used during limited visibility operations can create the “milk-bowl” effect, making it more difficult for a CAS aircraft to find its target. When used under a low cloud ceiling, flares can also highlight the aircraft against the cloud cover. Strobe lights are very good night markers. They are commonly used with blue or IR filters and can be made directional by the use of any opaque tube. In overcast conditions, strobe lights can be especially useful. Aside from the obvious security considerations, almost any light that can be filtered or covered and uncovered can be used for signaling aircraft.

**USAF Aircraft Characteristics.** CAS missions never consist of less than two aircraft sorties. These aircraft may make more than one pass over the target area except in high-intensity, high-threat situations, where the capabilities of modern air defense systems present added dangers. The following paragraphs provide examples of two types of aircraft, the A-10 and the A-7, that will normally be given CAS missions. Table 7-5 is a summary of reference data for aircraft that perform CAS missions; Table 7-6 is a summary of ordnance available for CAS.

Table 7-5. Aircraft reference data.

AIRCRAFT	MINIMUM CEILING	RADIOS	ACQUISITION MEANS	LOITER TIME*	NIGHT OPS CAPABILITY
A-7 USAF (RC) USN	2,000	UHF FM	Visual LST	30-40 min	Radar Flare LST
A-10 USAF	1,500	UHF VHF FM	Visual LST	1-2 hrs	Radar Flare LST
F-4 USAF (RC)	3,000	UHF	Visual Radar	20-30 min	Radar Flare FLIR
F-16 USAF	1,500	UHF VHF FM	Visual Radar	20-30 min	Radar Flare FLIR, LANTIRN
OV-10A, D USMC	1,500	UHF VHF FM	Visual LST	1-2 hrs	Radar FLIR LST
F-15E USAF	1,500	UHF VHF FM	Visual LST	20-30 min	Radar Flare FLIR, LST LANTIRN
F-111 USAF	700	UHF VHF	Visual Radar	20-30 min	Radar Flare FLIR



Table 7-5. Aircraft reference data (Cont).

AIRCRAFT	MINIMUM CEILING	RADIOS	ACQUISITION MEANS	LOITER TIME*	NIGHT OPS CAPABILITY
F/A-18, D USN/USMC	Mission Specific	UHF VHF-FM VHF-AM	Visual Radar LST	30-45 min	Radar FLIR LST/NVG
AV-8B USMC	Mission Specific	UHF VHF-FM VHF-AM	Visual LST	30 min	LST FLIR/NVG
A-6E USN/USMC	Mission Specific	UHF	Visual Radar LST	45-60 min	Radar FLIR LST
AC-130 USAF	1,500	UHF VHF-FM VHF-AM	Visual Radar LST	2-3 hrs	Radar FLIR LST

\*Loiter time is approximate based on flight time to and from the objective, ordnance, fuel pods, threat, and fuel tanker support. LST-laser spot tracker; FLIR-forward looking infrared; LANTIRN-low altitude navigation and targeting infrared for night; RC-reserve component (no longer in active inventory).

Table 7-6. Aircraft ordnance reference data.

WEAPON	DESCRIPTION	MINIMUM SAFE DISTANCE	
		(10% Pi)	(0.1% Pi)
MK 82 LD	500-lb bomb	250 m	425 m
MK 82 HD	500-lb bomb	100 m	375 m
MK 82 LGB	500-lb bomb (GBU-12)	*	*
MK 83 HD	1,000-lb bomb	275 m	500 m
MK 83 LD	1,000-lb bomb	275 m	500 m
MK 83 LGB	1,000-lb bomb (GBU-16)	275 m	500 m
MK 84 LD	2,000-lb bomb	225 m	500 m
MK 84 LGB	2,000-lb bomb (GBU 10-22)	*	*
MK 20**	ROCKEYE CBU	*	*
CBU-87	Combined effects munition	*	*
CBU-89	Gator munition system	*	*
CBU-97	Sensor fuzed weapon	*	*
SUU-11	7.62-mm mini-gun	*	*
M-4/M12/ SUU-23/M-61	20-mm Gatling gun	*	*
GAU-12	25-mm Gatling gun	*	*
GPU-5A/GAU-8A	30-mm Gatling gun	*	*
AGM-65	Maverick missile (TV/IR/laser)	*	*
MK 21/29	WALLEYE I 1,000-lb bomb (TV guided)	275 m	500 m
MK 23/30	WALLEYE I 2,400-lb bomb (TV guided)	*	*
AGM-123A	SKIPPER II 1,000-lb bomb (laser guided; rocket boosted)	275 m	500 m

\* Minimum safe distances have not been determined.  
 \*\*Not recommended for use near friendly troops.  
 Pi-probability of incapacitation; LD-low drag; HD-high drag; LGB-laser guided bomb;FFAR-folding fin aircraft rocket; GBU-guided bomb unit; AGM-air-to-ground missile.

The A-10 (Thunderbolt) is designed specifically for the CAS role. In a typical CAS mission, the A-10 could fly 150 miles and remain on station for an hour. It can carry up to 16,000 pounds of mixed ordnance with partial fuel, or 12,086 pounds with full internal fuel. The 30-mm GAU-8A gun carried by the A-10 can fire 2,100 or 4,200 rounds per minute and defeat the whole range of ground targets encountered in the CAS role, including tanks. In addition to the GAU-8A, the A-10 can also carry free-fall or guided bombs, gun pods, six AGM-65 Maverick missiles, jammer pods, and the Pave Penny laser spot tracker. A typical standard ordnance load for the A-10 is two to four Maverick missiles and over 1,100 rounds of 30-mm ammunition, consisting of an armor-piercing incendiary (API) and high-explosive incendiary (HEI) mix. The API has a depleted uranium penetrator. The Maverick used by USAF aircraft uses TV or IR seekers with fire-and-forget and day-night capabilities. The warhead is a 165-pound shaped charge for use against tanks or a 300-pound penetrating high explosive. Time required to acquire and lock the weapon onto a target usually restricts the A-10 to one missile per pass. In a target-rich environment, there may be time for further engagements with the 30-mm gun before breaking off the attack. The 30-mm gun is normally aimed at a point target and fired for a one-second burst of 30 rounds. The on-board load of 1,170 30-mm rounds, fired at 2,100 rounds per minute, could be expended in just 30 seconds.

The A-7 (Corsair) is a subsonic tactical fighter that was delivered to the USAF and Navy between 1968 and 1976. The A-7 has on-station time of 30 to 50 minutes with a maximum speed of 663 mph. The aircraft's outstanding target kill capability, first demonstrated in Southeast Asia, is achieved with the aid of continuous-solution navigation and weapon-delivery systems, including all-weather radar bomb delivery. Additionally, a large number of A-7s were modified to carry the same Pave Penny laser target designation pod as the A-10. The A-7 can carry up to 15,000 pounds of air-to-air or air-to-ground missiles, bombs, rockets, and gun pods. In addition, it has the standard M-61A1 20-mm Vulcan gun, which is effective against lightly armored vehicles.

The F-16 (Fighting Falcon) is a single-engine, single-seat, lightweight, high-performance, multirole aircraft. This highly maneuverable fighter excels in air-to-air and air-to-surface roles. In the air-to-surface role, using a 20-mm Gatling gun, it is the most accurate aircraft in the inventory and can be used for both CAS and AI.

## US NAVY/MARINE CORPS TACTICAL AIR SUPPORT

US Navy (USN) and/or US Marine Corps (USMC) air requests are forwarded by the respective SALTs to the aviation unit in support of the unit. The brigade FSO submits all air requests, including those for USMC attack helicopters (AH-1W Cobra), through the Marine air officer or ANGLICO. The actual terminal control of the air assets is done by the firepower controller of the FCT. In the absence of an observer, USN and/or USMC air may be controlled by the company FSO, the ALO, or the USAF FAC.

Like USAF support, USN/USMC TACAIR never consists of less than two aircraft sorties. These aircraft may make more than one pass over the target area, but loiter time is contingent on transit distance. Refer to Figure 7-4 and Table 7-1 for additional information. The following are the two most common USN/USMC aircraft that provide CAS to light armor operations.

- The F/A-18/D (Hornet) is an extremely versatile aircraft that can provide excellent CAS with its 20-mm rotary cannon and a basic load of either 515 or 580 rounds. Loiter time is 30 to 45 minutes, depending on external fuel tanks and ordnance load. The F/A-18 can carry 13,700 pounds of conventional ordnance consisting of 2.75-inch and 5-inch rockets, Walleye, HELLFIRE, TOW missiles, fuel-air explosive (FAE) and flares. It is equipped with a laser designator, radar, and FLIR/NVG. The maximum speed is 1,190 mph (without ordnance or external fuel tanks).

- The AV-8B (Harrier) can also provide CAS with its 25-mm rotary cannon, however, its basic load is only 300 rounds and can only remain on station for up to 30 minutes. The AV-8B can carry 8,000 pounds of the same type of external ordnance as the F/A-18. For target acquisition, it has LST and FLIR/NVG. The maximum speed is 685 mph (without ordnance or external fuel tanks).

## Section III. Army Aviation Support

Army aviation assets will deploy with light infantry contingency TFs. Light armor units may operate with attack and/or reconnaissance aviation assets to perform reconnaissance and security operations.

### ORGANIZATION

The organization of the light division aviation brigade and reconnaissance squadron is dependent upon whether the division is light, airborne, or air assault. The ACT in each type of division, however, has the same organization.

### CHARACTERISTICS

The capabilities of the AH-1, AH-64, and OH-58D attack helicopters include—

- The AH-1 Cobra can carry multiple loads, dependent on the mission, enemy situation, and atmospheric conditions. Weapon systems include 2.75-inch rockets, 7.62-mm minigun, 40-mm grenade launcher, 20-mm cannon, and TOW.
- The AH-64 Apache is equipped with the pilot night vision sensor to enhance flight during periods of reduced visibility. It also has a target acquisition sight/designator to laser targets for laser energy-seeking munitions. Its weapon systems include 2.75-inch rockets, 30-mm cannon, and the HELLFIRE missile.
- The OH-58D (Kiowa Warrior) is the armed version of the OH-58 (AHIP) with HELLFIRE, Stinger, 2.75 rockets, and .50 caliber machine guns. The helicopter is equipped with a thermal imaging system (TIS) and a low-light camera system. The helicopter is capable of operating on a digital TACFIRE network. The Kiowa Warrior will eventually replace all Cobras and Kiowas in the cavalry squadrons and attack battalions of the light and airborne divisions.

### EMPLOYMENT

The aviation brigade provides divisional Army aviation support. This support can be for attack, air movement, air assault, reconnaissance, intelligence, security, and/or logistical operations. Cargo helicopters (CH-47s) are available only in the aviation brigade of the air assault division or at corps level.

Light armor leaders at all levels must be aware of the integration of Army aviation assets into the maneuver plan so that light armor and rotary aircraft can work efficiently as a team.

Light armor units will normally work with Army aviation assets in reconnaissance, security, or logistical roles.

An ACT may operate with a light armor battalion during a reconnaissance or screen mission. Planning and guidance for future operations are conducted by the light armor battalion. The light armor unit commander assigns missions to the ACT commander. The light armor battalion staff provides essential intelligence, logistical, and FS information. The ACT

commander can respond quickly to support a ground commander's scheme of maneuver. The minimum information he must know is—

- Enemy situation.
- Availability of FS.
- FS coordination measures in effect.
- Current battlefield graphics.
- Attack helicopter assets in the area.
- Disposition of friendly ground elements.
- Commander's relationship to the new unit.
- Person to whom spot reports are to be reported.
- Location of supporting Classes III and V aviation assets.

An ACT may also work with light armor companies or platoons as a reconnaissance team. For example, during the early stages of a CONOPS, air reconnaissance aircraft can provide early warning for the mobile light armor ground force tasked to provide security for the airhead. Available light armor and ACT assets can be task organized by the commander to provide a highly mobile screening force in a predominantly dismounted brigade AO.

**Attack Helicopter Mission.** The primary mission of attack helicopters is to destroy massed enemy forces with aerial firepower, mobility, and shock effect. Light armor with attack helicopter augmentation significantly gain, maintain, and exploit the initiative to defeat the enemy. They operate in offensive, defensive, or special purpose operations. The attack helicopter can be committed early in battle. It can reinforce ground combat units and can attack, delay, or defend by engaging the enemy with direct and indirect fires. Attack helicopter battalions cannot seize or retain terrain without cross-attached ground maneuver forces. However, to deny terrain to the enemy for a time, they can dominate the terrain by fire. Also, attack helicopters are limited by a combination of fuel capacity and flight time, weather and visibility restrictions, and the air defense environment. They are most effective when employed as a battalion. Attack helicopters can also be assigned to do the following:

- Conduct rear operations.
- Coordinate and adjust indirect fires.
- Suppress or destroy enemy air defense assets.
- Reinforce ground maneuver forces by fire.
- Conduct JAAT operations with CAS and FA assets.
- Destroy enemy communication and logistical assets.
- Disrupt and destroy enemy second echelon and follow-on forces.
- Protect air assault forces during all phases of air assault operations.
- Destroy enemy helicopters that pose an immediate threat to mission accomplishment.

**Considerations.** The commander must consider the following factors before employing attack helicopters and air cavalry/reconnaissance troops.

**Offense.** Attack helicopters conduct combat operations against enemy force alone or along with friendly ground forces. In the offense, attack helicopters are most effective against a

moving or counterattacking enemy force. They are least effective against a dug-in enemy force. With proper planning, attack helicopter battalions can provide antiarmor firepower against an enemy armored force. Rather than being used as a reaction force, attack helicopter battalions should be integrated into the maneuver battalion's scheme of maneuver. This is normally done at division or brigade level and must include coordination for terrain to support attack helicopter operations.

**Defense.** Attack helicopters, due to their mobility are shifted on the battlefield as needed. They are used to stop enemy penetration into the main battle area, to attack enemy in the covering force area, or to reinforce or thicken the defense on parts of the battlefield. They can also perform effectively in an economy-of-force defensive role. Planners must coordinate BPs for attack helicopters.

The light armor battalion may, on rare occasions have attack helicopter assets OPCON to assist in an antiarmor battle. An army aviation LO may be provided to the battalion to coordinate aviation support when this type of mission is planned. He will advise the commander and assist in planning the use of aviation assets to support the maneuver plan.

## Section IV. Air Defense Support

Air defense planning is critical to light armor units. Light divisions, unlike armored or mechanized divisions, do not create a signature that is easily identifiable by aircraft. When moving, however, light armor produces a battlefield signature that can be easily observed by enemy attack aircraft. Commanders should consider task organizing air defense assets to light armor units to counter this threat. Light armor leaders must stress to their attaching headquarters the importance of air defense support.

### ORGANIZATION

The normal air defense support provided to the light armor battalion is a Stinger section. On occasion, the battalion may also receive an Avenger platoon. The unit's mission and the division commander's air defense priorities will determine the type and amount of air defense weapons allocated to the battalion.

The Stinger section consists of a section headquarters with a section chief, his driver, and five man-portable air defense systems (MANPADS) teams. Each team consists of two team members and six missiles mounted on a HMMWV.

The Avenger platoon consists of six Avenger fire units. Each Avenger team consists of two team members and a HMMWV.

**Senior Air Defense Officer.** The senior air defense representative for the light armor battalion will be the Stinger section sergeant or, in some cases, the Avenger platoon leader. Either will serve as a special staff officer during the battalion planning process. Based on the commander's intent and priorities, scheme of maneuver, air IPB, and higher headquarters OPORD, the senior air defender will develop the air defense plan. Once it is approved, he will task organize his assets to provide protection to these priorities. After receiving approval for his task organization, he will ensure it is incorporated into the OPORD. The senior air defender will coordinate with the staff sections of the battalion. The battalion staff should provide the air defense officer with the following information:

- The S2 provides information on the ground and air threat and the unit's PIR. The air IPB is maintained and can be developed by the S2 and the senior air defender.
- The S3 provides the unit OPORD and tactical SOP. This includes overlays; preplanned locations; commander's intent; and concept of the primary operation and follow-on operations; commander's priorities; what units expect heaviest ground and air action;

what assets are most critical, most vulnerable, and easiest to recover or replace; special or modified brevity or operations codes, key words, or emergency procedures; points the battalion commander wants covered in daily briefs; SOI; resupply; the unit's MOPP status; and how changes are disseminated.

- The S4 provides the following resupply information: Class I pickup points, times, and feeding cycles; Class II resupply of NBC suits, gear, and batteries; Class III refueling locations and times; Class V arrangement for supply of specialized ammunition; Class LX procedures for ordering and receiving parts and locations and times for pickup. He also determines how resupply is handled and, if the air defense unit has been considered in the planning, who will maintain air defense units' nonsystem-peculiar equipment and where these maintenance assets are located.

**Air Defense Annex.** Once the battalion commander gives his maneuver plan and intent for air defense, the senior air defender can prepare the annex to the OPORD. He may either write his plan as a five-paragraph annex to the OPORD or as an execution matrix. The senior air defender must conduct detailed coordination with other staff sections to develop these instructions.

## CHARACTERISTICS

**Stinger.** The Stinger is a man-portable, shoulder-fired, IR-homing (heat-seeking) air defense guided missile. It has a range of more than 5 Kilometers. It is designed to counter high-speed, low-level ground attack aircraft, helicopters, observation aircraft, and transport aircraft. It is maneuverable and can be integrated within the unit's scheme of maneuver. Since its prime mover is a thin-skinned HMMWV, the Stinger should overwatch the force from high ground.

**Avenger.** The Avenger air defense weapon system is the line-of-sight rear (LOS-R) family of forward area air defense (FAAD) weapon systems designed to counter high speed, low-level, fixed-wing helicopters; observation aircraft and transport aircraft. The Avenger carries eight ready-to-fire Stinger missiles mounted on a HMMWV. The Avenger team can conduct stationary and mobile operations. The major components of the Avenger are a rotatable turret with two standard vehicle missile launchers (SVML); a gun system (.50 caliber machine gun); a forward looking infrared (FLIR); a laser range finder (LRF); identification, friend or foe (IFF); and a remote control unit (RCU). The Avenger will normally be used to defend assets in the division and brigade rear area. The Avenger is a light-skinned weapon system, but it can be used to support maneuver operations dependent on the factors of METT-T.

## EMPLOYMENT

The TF commander must consider the factors of METT-T and provide his intent for the operation. The senior air defender allocates air defense assets based on the TF commander's ADA priority considerations and employment guidelines. He then provides input on the COAs and air defense priorities during the planning process.

**Rules of Engagement (ROE).** Air defense ROE are directives that specify the circumstances under which an aircraft can be engaged. The Stinger team chief and Avenger squad leaders are responsible for deciding whether an aircraft is hostile or friendly. ROE include hostile criteria and weapon control statuses:

- Hostile criteria include aircraft that attack friendly elements, violate airspace control measures, respond improperly to IFF interrogation, and are visually identified as an enemy.

- The following weapon control statuses describe relative degrees of restriction with which fires of ADA systems are managed:
  - Weapons free. Fire at any aircraft not positively identified as friendly.
  - Weapons tight. Fire only at aircraft identified as hostile according to prevailing hostile criteria.
  - Weapons hold. Do not fire except in self-defense or in response to a formal order.

**Air Defense Warnings.** These warnings indicate the probability of hostile aircraft and/or missile attack:

- Red. Attack by aircraft or missile is imminent or in progress.
- Yellow. Attack by hostile aircraft or missiles is probable.
- White. Attack by hostile aircraft or missiles is improbable.

Local air defense warnings (LADW) are used at division level and below. Each LADW has a corresponding action taken by maneuver units according to the division TSOP. Some examples are—

- DYNAMITE: Aircraft are inbound or attacking now. Response is immediate.
- LOOKOUT: Aircraft are in the area of interest, but are not threatening or inbound yet.
- SNOWMAN: No aircraft pose a threat at this time.

**Responsibilities.** The Avenger platoon leader commands and maneuvers his platoon from his HMMWV; he does not collocate. The platoon leader monitors the battery command net, the early warning net, the supported unit, and the platoon command net. Each Avenger team monitors the early warning and platoon command nets. The Avenger platoon sergeant is responsible for platoon logistics. He collocates with battalion trains and moves forward with the platoon ammunition vehicle to provide logistical support for the platoon.

The Stinger section chief commands his section from his HMMWV. Once he has task organized his section, he can monitor the early warning net within the TOC. The section chief monitors the early warning net, the section command net, and either the battery command or the supported unit net. The Stinger team monitors the early warning and section command nets. The Stinger section chief is responsible for section logistics. He must ensure that he coordinates with the Stinger platoon sergeant for missile resupply.

**Company Air Defense.** The senior air defender for the company is the Avenger platoon leader or the Stinger team chief. He advises the company commander on the integration of the air defense assets and passive air defense. If an Avenger platoon is attached at the company level, the platoon leader locates his HMMWV within the company formation where he can best C2 his platoon. The Avenger platoon is integrated in the unit battle formation and monitors the company commander's net. Avenger can provide a 24-hour capability with the FLIR for night operations.

If the company receives a Stinger team, it provides air defense by integrating or over-matching the force. The Stinger crew chief and the company commander determine how best to employ the Stinger weapon system. Crew survivability considerations are critical, since the crew is vulnerable because it is in a thin-skinned vehicle.

**Platoon Air Defense.** Light armor platoon leaders must keep in mind the signature their tracked vehicles will produce. Tracked vehicles moving in a predominantly dismounted infantry AO produce a significant signature to aircraft. The platoon must maintain air guards and monitor higher headquarters nets for early warning of air attack, especially when on the

move. The platoon leader should designate a tracked vehicle to watch for enemy air. The platoon leader also coordinates small-arms air defense against hostile aircraft.

## Section V. Engineer Support

The design of the division engineers in light divisions (light infantry, airborne, and air assault) provides them very limited ability to support light armor units. A light armor battalion task organized to a light division will normally require augmentation from corps engineers for the necessary mobility and survivability support.

The light armor battalion should be supported by a corps engineer company (airborne, light, wheeled, or mechanized), and a light armor company by a corps combat engineer platoon. The support a light armor platoon receives will depend on METT-T and the commander's intent.

A light armor battalion may possess assault bridging capability, and in-stride breaching capability for surface-laid mines and unexploded ordnance (UXO). Additional assault bridging and all tactical bridging support must come from the corps engineers. Corps engineers also possess mobility systems that can create vehicle lanes through minefields and complex obstacles. Two-tier fighting positions for light armor battalion vehicles will normally require corps engineer support, due to the limited amount of earthmoving assets in the light division engineer battalion.

### ORGANIZATION, CHARACTERISTICS, AND CAPABILITIES

**Light Division Engineer Battalion.** A light division (light infantry, airborne, and air assault) is supported by an organic engineer battalion. The engineer battalion is designed to deploy rapidly during contingency operations by using lightweight equipment that can be airlanded or air dropped. Their primary mission is to provide combat engineer support to dismounted infantry units.

The organic light engineer battalion which supports a LID is the most austere type of division engineer battalion. Its engineer squads move on foot like the infantry units they support. The engineer equipment in the light engineer battalion consists of lightweight, high-speed bulldozers, and small emplacement excavators (SEE), and the Volcano scatterable mine system. The light engineer battalion may provide limited countermobility and survivability support to light armor units, but it is incapable of providing the necessary mobility support due to its lack of assault bridging and vehicle lane breaching systems. A detailed discussion of the light engineer battalion is contained in Appendix B.

The organic airborne engineer battalion which supports the airborne division is more robust than a light engineer battalion. Its engineer squads have HMMWVs as squad vehicles to support the airborne infantry. The engineer equipment in the airborne engineer battalion consists of lightweight, high-speed bulldozers, scoop loaders, SEEs, and the Volcano scatterable mine system. They can provide the countermobility support, and limited mobility and survivability support to light armor units. The airborne engineer battalion lacks assault bridging and vehicle lane breaching systems needed to properly support light armor. A detailed discussion of the airborne engineer battalion is contained in Appendix C.

The organic air assault engineer battalion which supports the air assault divisions is the most equipment intensive of the light engineer battalions. Its engineer squads have HMMWVs as squad vehicles to support the air assault infantry. The engineer equipment in the air assault engineer battalion consists of a combination of sling loadable bulldozers and lightweight, high-speed bulldozers, scoop loaders, SEEs, and the Volcano scatterable mine system. They can provide mobility and countermobility support, and limited survivability support to light armor units. The air assault engineer battalion does not have assault bridging



capability. A detailed discussion of the air assault engineer battalion is contained in Appendix D.

The use of organic division engineers to support light armor units task organized to a light division must be carefully weighed against METT-T and the commander's intent. The combat engineer support task organized to light armor units will in turn deprive other elements in the light division of engineer support, due to the austerity of engineer equipment in the light division engineer battalion.

**Corps Engineer Brigade.** A light division engineer battalion is routinely augmented with engineers from the corps engineer brigade. This augmentation increases the capability of the engineers to provide mobility, countermobility, and survivability support, and sustains the force. The types of engineer units in the corps engineer brigade is primarily based on the types of divisions making up the corps.

**Corps Combat Engineer Battalion (Airborne and Light).** These corps engineer battalions are designed to deploy rapidly during CONOPS by using lightweight equipment that can be air dropped or airlanded. The primary difference between the corps airborne combat engineer battalion and the corps light combat engineer battalion is that the airborne battalion can air drop its equipment, while the light battalion must airland its equipment.

Both of these battalions are designed to augment the capabilities of the light division engineer battalion. They provide the capability to breach vehicles' lanes through minefield and wire obstacles using the mine clearing line charge (MCLIC), but lack assault bridging equipment. Countermobility effort is enhanced by additional engineer squads, Volcano scatterable mine systems, and earthmoving equipment. The survivability effort is increased by the additional earthmoving equipment in these two types of battalions. These battalions provide a limited sustainment engineering capability for the light divisions and the corps, before more robust heavy force engineer equipment can be deployed to the contingency area.

The corps airborne and the corps light combat engineer battalions use 5-ton dump trucks for engineer squad vehicles. The engineer earthmoving equipment consists of lightweight bulldozers, graders, scoop loaders, scrapers, and SEEs.

**Corps Equipment Company (Airborne and Light).** These corps engineer companies are designed to deploy rapidly during CONOPS by using lightweight equipment that can be airdropped or airlanded. The primary difference between the corps airborne equipment company and the corps light equipment company is that the airborne company can air drop its equipment, while the light company must airland its equipment.

Both of these equipment intensive companies are designed to augment the capabilities of the corps airborne and corps light combat engineer battalions. They are normally attached to a corps engineer battalion for C2, and logistics support.

The corps airborne and corps light equipment companies enhance the mobility, countermobility, survivability, and sustainment engineering efforts by providing additional horizontal earthmoving equipment for the light divisions and corps.

The corps airborne and corps light equipment companies' earthmoving equipment consists of lightweight bulldozers, graders, scrapers, and 5-ton dump trucks for hauling.

**Corps Combat Engineer Battalion (Mechanized and Wheeled).** These corps engineer battalions can support light or armored forces in the area of mobility, countermobility, and survivability. They are equipment intensive organizations that usually deploy by ship, but are capable of transport by air in special company or platoon packages.

The corps mechanized combat engineer battalion is designed to support armored forces. Its engineer squads are mounted in M13 APCs. Mobility support is provided by MCLICs, M-9 ACES, and CEVs. It is the only corps engineer organization that has AVLBs for assault bridging. Countermobility is provided by the Volcano scatterable mine system, engineer

squads, and the various blade systems (ACE, CEV, and SEE). Extensive survivability positions can be emplaced by the blades in this battalion.

The corps wheeled combat engineer battalion mounts its engineer squads in 5-ton dump trucks. Mobility support is provided by MICLICs, heavy bulldozers, and scoop loaders. Countermobility is provided by the Volcano scatterable mine system, engineer squads, and the various blade systems (bulldozer, scoop loader, and SEE). Extensive survivability positions can be emplaced by the blades in this battalion. The corps wheeled combat engineer battalion does not have any bridging capability. The battalion can perform limited sustainment engineering tasks in the light divisions and corps AO.

**Corps Bridge Company (Ribbon and Medium Girder).** The corps mechanized combat engineer battalion with its AVLBs is the only engineer unit that can support light armor units with assault bridging assets. The other bridging assets available from the corps engineers are ribbon bridge and medium girder bridge (MGB). The corps ribbon bridge and corps MGB companies are task organized to divisions based on METT-T and the corps commander's guidance.

Both of these bridging systems are designed to be emplaced out of the range of enemy direct fire and observed indirect fire. These bridges are normally emplaced as part of a division level operation.

## EMPLOYMENT

**Task Organization.** Special attention must be placed on the task organization of combat engineers to support light armor units. The organic engineer battalion in the light division is normally incapable of providing the necessary engineer support to light armor in the areas of mobility and survivability.

The engineer battlefield assessment (EBA) in conjunction with the IPB is vital to identify engineer missions and recommend the task organization of light division and corps engineers to maximize combat engineer support. It is easy to over estimate the capabilities of the division light engineer battalion to support light armor units.

It is preferred to task organize engineer platoons and critical equipment assets between engineer companies, rather than move engineer companies between the light division's brigades and maneuver TFs. This approach minimizes the disturbance of habitual relationships between engineers and the supported maneuver unit, engineer and maneuver staff planning time, TF logistics system, and link-up coordination and time tables. An engineer unit should seldom be task organized below platoon level. An exception would be a reconnaissance mission, which requires an engineer platoon to delegate squads to scout platoons.

Corps engineer units will normally be task organized in a command relationship to a light division to support light armor units in the division for an offensive mission. Task organization will normally be a support relationship for a defensive mission. A corps combat engineer company should support a light armor battalion, and a corps combat engineer platoon should support a light armor company.

The type and number of corps engineer units available to support the light armor unit in a light division depend on a variety of factors peculiar to the contingency situation and geographical location.

The same CSS considerations used when task organizing light armor units to a light division apply for the corps engineer units that support light armor. A corps engineer unit will quickly overwhelm the CSS system in a light division unless additional assets are being provided from the corps support command (COSCOM) to the DISCOM in the light division.

## COMMAND AND CONTROL

Corps engineer units task organized to a light division are normally under the control of the division engineer.

In a light division, the organic division engineer battalion forms a habitual association between its engineer companies and each infantry brigade. In turn, an engineer platoon leader is normally the TF engineer for each infantry battalion in the brigade.

If possible, do not alter this habitual relationship between the engineers and infantry when light armor is task organized to a light division. To minimize turbulence in the light division's TFs, the habitually associated division engineer platoon leader should remain the TF engineer, even after a light armor unit is task organized to his supported TF. The corps engineer unit, task organized to the light division to support the light armor unit, should assist the habitual TF engineer with his duties and responsibilities. For example, if a light armor company and a corps engineer platoon were task organized to a light infantry battalion, the corps engineer platoon leader would assist the habitually associated division engineer platoon leader in his duties as the TF engineer.

If the light armor battalion operates as a TF headquarters in the light division, the corps engineer company commander supporting the light armor battalion TF should be the TF engineer.

The augmenting corps engineer units can typically provide better C2 for the engineers in the supported TF than the light division engineers due to their greater number of long-range radios and command vehicles.

## OPERATIONS

Engineers supporting light armor units can significantly enhance the combat power of light armor during offensive and defensive operations when properly integrated into the maneuver plan and tactical formations. Engineers provide diverse and flexible reconnaissance capabilities with mobility equal to that of light armor. They should assist light armor scouts in the R&S plan.

**Mobility.** Corps engineers augment the in-stride breaching capability against surface-laid mines and UXO that light armor units possess. Corps engineers provide additional capability to breach vehicle width lanes through minefield and complex obstacles, to include UXO. Corps mechanized combat engineers with AVLBs augment the assault bridging capability in the light armor battalion. Corps engineer mobility support provides light armor units enhanced freedom of maneuver, and permits more responsive logistical support of light armor units by trailing unit trains and CSS units. Light division engineers are incapable of providing the same level of mobility for light armor as corps engineers.

The extensive earthmoving capability of the corps engineer units not only provides the ability to reduce nonexplosive obstacles, but also facilitates the maneuver of light armor. The construction or repair of combat roads, trails, and ford sites by corps engineers may provide light armor and their CSS support packages with mobility between BPs or along axes of advance. During the early stages of a CONOP, corps engineers may construct or repair forward airfields or landing zones (LZ) for the deployment or sustainment of light armor units. Corps engineer units will often work with light division engineer units to execute these types of missions.

**Countermobility.** Corps engineers supporting light armor augment the countermobility capability of the light division engineers by providing additional engineer squads, vehicle mounted scatterable mine systems, and a more robust logistical capacity for the emplacement of obstacles. In addition to hand emplaced conventional mines and demolitions, engineers

possess a tremendous dynamic obstacle capability with their vehicle mounted scatterable mine systems. This capability allows the supported unit to emplace dynamic minefields faster, in greater numbers, and more accurately than artillery-delivered FASCAM minefield, without the corresponding loss of indirect FS.

The vehicle mounted scatterable mine systems may be employed in offensive operations to provide security to the flanks of attacking light armor, or to block potential counterattack routes against an armor or dismounted threat. In the defense, the scatterable mine systems augment hand emplaced conventional mine and demolition efforts. Scatterable minefield can be emplaced faster than conventional mines, with less manpower, with equal or better lethality than hand-emplaced conventional minefield. They are ideally suited for mobile defenses and retrograde operations in support of light armor.

**Survivability.** The robust earthmoving capability of corps engineer units provides light armor units with increased survivability on the battlefield. Corps engineer can provide light armor vehicles with doctrinal two-tier fighting positions, as well as protective positions for their combat trains and logistics support tail. Corps engineers normally augment the light division engineers in providing force protection for the light division's BSAs and C2 nodes.

## Section VI. Nuclear, Biological, and Chemical Support

### ORGANIZATION, CHARACTERISTICS, AND CAPABILITIES

**Battalion Chemical Section.** This section consists of the battalion chemical officer (lieutenant), a chemical operations NCO (staff sergeant; MOS 54B30), and an NBC specialist (MOS 54B10). Equipment in the section includes appropriate doctrinal manuals, map boards, overlays, work station, hazard templates, status charts, and lightweight decontamination system. The battalion chemical section's primary responsibility is to train first-line leaders and plan NBC operations.

The battalion chemical officer works as an assistant operations officer in the company operations section. The chemical officer and NCO are assigned by modified tables of organization and equipment (MTOE) to the headquarters company. Together, they form the NBC center at company level and are responsible for the technical aspect of operations as well as training, logistics, and readiness. The battalion chemical officer serves as the battalion commander's chief advisor on all NBC, smoke, and flame operations. He advises the battalion commander on the employment of smoke, decontamination, and NBC reconnaissance assets DS or attached to the battalion. He assists in the coordinating of logistical requirements for these units. He informs the battalion commander on all threat NBC capabilities and ensures they are reflected on all plans and OPORDs. He assists the S4 in the acquisition of all NBC defense equipment and the forward pre-positioning of decontaminates and fog oil. He prepares and plots the locations of NBC hazards and advises the commander on the appropriate defense measure requirements. He provides assistance to subordinate commanders on NBC, smoke, and flame operations.

Assignment of the chemical specialist and lightweight decontamination system authorization gives the battalion hasty decontamination capability. The battalion chemical officer and NCO supervise and train battalion decontamination operations.

**Company NBC Section.** The NBC section at company team level consists of one chemical operations specialist (MOS 54B20) and one additional-duty officer and enlisted alternate (branch immaterial). Equipment includes appropriate doctrinal manuals, map boards, overlays, work station, hazard templates, and status charts.

The assigned chemical specialist works in company operations, where he is immediately available to the company commander as the primary advisor for all NBC matters. Like their counterparts in higher echelons, chemical personnel at company level are responsible for

training first-line leaders and monitoring other NBC training. They are the focal point for all NBC actions in garrison and in the field.

The company chemical operations specialist is instrumental in the planning cycle of all tactical operations. He provides assistance to the commander by evaluating information received in NBC warning and reporting system (NBCWRS) reports. He plans decontamination, smoke, flame, and NBC reconnaissance operations and supervises their execution. While maintaining status charts for MOPP levels and radiation exposure, the chemical NCO also plans for future operations. The company chemical NCO may be positioned anywhere on the battlefield the commander directs. To ensure timely and accurate battlefield assessment, the commander positions the chemical NCO according to the principles of accessibility and immediacy.

## EMPLOYMENT AND OPERATIONS

**Battalion Operations.** During tactical operations, battalion chemical personnel provide 24-hour NBC operations capability. A work station is designated in the TOC where chemical information is processed and disseminated. The chemical officer is available to cover shift changes within the TOC and provide chemical continuity for tactical operations. This allows the chemical officer to coordinate and, when operations permit, physically supervise battalion decontamination, smoke, and NBC survey/chemical reconnaissance operations.

Battalion chemical personnel are instrumental in the planning cycle of all tactical operations. They provide assistance to the battalion intelligence officer in the IPB process, develop NBC support for COAs based on the commander's intent, and integrate chemical and smoke operations based on the OPORD. Once the plan is developed, they ensure successful execution.

The duties and responsibilities of chemical personnel in the battalion TOC are listed in the following paragraphs. These are not all-inclusive and are manipulated to meet changing situations. In addition to these specific chemical duties, chemical officers and NCOs also perform a myriad of operational duties according to their abilities and unit needs.

**Intelligence.** Receive, relay, and disseminate NBC information; recommend NBC reconnaissance employment; provide NBC threat briefings.

**Personnel.** Ensure proper employment and professional development of chemical personnel; coordinate proper use of chemical company assets; coordinate with S1 on chemical casualty evacuation.

**Training.** Coordinate and monitor training; integrate battle tasks in NBC environment; evaluate individual and collective battle tasks; understand battle focus process and take active role in planning.

**Evaluation.** Conduct individual and collective proficiency testing; analyze and report results; and develop solutions to correct deficiencies.

**Readiness.** Report equipment status; determine authorization shortfalls; assist S4 with NBC stocks and resupply; monitor contingency stocks.

**Logistics.** Account for NBC expenditures; follow up requisitions and maintenance; match requisitions to authorizations; conduct inspections.

**Tactical Operations.** Execute NBC warning and reporting system; maintain current operations overlay; post all NBC attacks; post offensive NBC targets; coordinate with S4 regarding MSR; work closely with S2; maintain radiation exposure data; recommend MOPP levels; recommend chemical asset employment; develop obscuration plan; participate in planning cycle from IPB through execution; develop and execute hasty decontamination operations; coordinate operations with the battalion medical section and FSB medical company through the combat trains CP; coordinate operations of supporting chemical units

with the battalion S3, brigade NBC section, and chemical units and conducts nuclear and chemical vulnerability analysis.

**Company Operations.** The duties and responsibilities of chemical personnel in the company CP are listed in the following paragraphs. These are not all-inclusive and are manipulated to meet changing situations. In addition to these specific chemical duties, additional duties may be assigned by the commander.

**Intelligence.** Analyze NBC threat; operate NBCWRS; coordinate NBC reconnaissance assets; brief all new personnel on NBC threat.

**Training.** Determine need for and provide technical training to first-line supervisor; plan and coordinate conduct of NBC battle focus; monitor and evaluate status of training.

**Evaluation.** Conduct evaluation of NBC proficiency at individual and collective levels.

**Readiness.** Maintain status reports; consolidate and provide data to commander and 1SG; assist supply sergeant with NBC stocks and resupply; monitor contingency stocks.

**Logistics.** Account for NBC expenditures; follow up requisition and maintenance; balance equipment on hand and requisition additional equipment; monitor crew maintenance; ensure radiac instruments are calibrated.

**Administration.** Operate a company NBC room.

**Tactical Operations.** Execute the NBCWRS; maintain current operations overlay; post NBC attack overlay; maintain decontamination overlay; supervise use of NBC equipment conduct hasty decontamination operations; supervise NBC surveys; post NBC unit symbols; maintain radiation status charts; recommend MOPP levels; recommend employment of chemical assets; and participate in planning operations.

**COMBAT SERVICE SUPPORT**

Light armor units are usually deployed as platoons task organized to light infantry battalion TFs or in a brigade-size force as a light armor company. The infantry TF does not have the necessary CSS capability to sustain the light armor force, and the light armor platoon cannot sustain itself without help. This presents a unique situation regarding CSS. Limitations due to aircraft availability and the priority of combat systems delivery during initial stages of CONOPS add to the challenge. This chapter first discusses contingency CSS techniques and procedures, then describes CSS for the light armor battalion overall.

CONTENTS		Page
Section I. Light Armor Combat Service Support Fundamentals . . . . .		8-2
Section II. Contingency Combat Service Support Operations . . . . .		8-3
Deployment . . . . .		8-3
Planning Considerations . . . . .		8-3
Phases of Supply . . . . .		8-4
Classes of Supply . . . . .		8-5
Distribution of Supply . . . . .		8-7
Resupply by Air . . . . .		8-7
Maintenance . . . . .		8-8
Techniques for Deploying Light Armor Combat Service Support in the Assault Force. . . . .		8-9
Section III. Operations . . . . .		8-11
Task Force Trains . . . . .		8-11
Combat Trains . . . . .		8-12
Company Trains . . . . .		8-12
Section IV. Supply and Resupply Techniques . . . . .		8-14
Classes of Supply . . . . .		8-14
Supply Procedures . . . . .		8-17
Resupply . . . . .		8-18
Battalion Logistics Package . . . . .		8-19
Pre-Positioning Supplies . . . . .		8-25
Night Resupply Operations . . . . .		8-27
Section V. Maintenance Techniques. . . . .		8-27
Procedures . . . . .		8-28
Forward Support Maintenance . . . . .		8-28

<b>CONTENTS (Cont)</b>	
	Page
Section VI. Field Services . . . . .	8-32
Mortuary Affairs . . . . .	8-32
Clothing Exchange and Bath..... . . . .	8-33
Salvage Services . . . . .	8-33
Section VII. Personnel Support . . . . .	8-33
Personnel Services . . . . .	8-33
Religious Support . . . . .	8-34
Legal Service Support . . . . .	8-34
Finance Service Support . . . . .	8-34
Postal Service Support . . . . .	8-34
Enemy Prisoners of War . . . . .	8-34
Section VIII. Health Service Support. . . . .	8-35
Organization . . . . .	8-35
Operations . . . . .	8-35

## **Section I. Light Armor Combat Service Support Fundamentals**

CSS planning must be continual to support the tactical operation. Considerations must be given to everything that can affect the mission. CSS functions are performed as far forward as the tactical situation permits. CSS staff officers and commanders must plan CSS operations concurrently with the tactical plan. Planning priorities must be given to those areas that are vital to mission accomplishment.

CONOPS require that the force first be tailored for the specific mission, then echeloned to permit simultaneous deployment and employment. The initial assaulting echelon must organize with sufficient combat power to seize the lodgement and begin combat operations. The echelon that immediately follows must be equipped to expand the lodgement and undertake decisive combat operations. The final echelon must provide the sustainment for expanded operations.

Unlike traditional operations, CONOPS require that CSS as well as C2 be phased in early. Echelonment of light armor forces is not as simple as putting combat forces first, followed by CS and CSS. It requires corresponding echelonment of CSS as well. Rapid transition to decisive combat or other operations dictates that CSS accompany or closely follow each echelon. The organization and quantity of required CSS must be carefully determined to support the operation, considering both the potentially scarce transportation assets and/or the austere infrastructure of light infantry CSS assets.

Light armor may also be required to operate with other services. Support requirements and quantities depend on the mission, but the capabilities of the parent unit’s CSS could be easily stressed. Proactive planning is necessary. The committed light armor force, whatever its size, must have accompanying CSS. Echelonment is the key, and redundancy is essential.

Light armor units may require augmentation for resupply and maintenance support for some CONOPS. Sustainment of CONOPS is also phased and requires detailed planning to



ensure the force is sustained in each phase. It is critical to synchronize the deployment of CSS units, supplies, and C2 with the increase in combat capabilities.

Light armor may require augmentation from corps units to conduct extended operations. It is imperative that the corps remain responsive to the battalion's operational needs and provide the required augmentation. This is especially critical when the battalion is conducting operations in a war environment.

The light armor battalion normally does not possess the required logistical redundancy to sustain forces providing augmentation throughout the division. These forces must normally deploy with their own sustaining and unique support packages, which are either organic or are provided by division and/or corps assets. Special consideration is given to the maintenance, repair, supply, transportation, and external communications requirements that augmentation forces provide to the unit.

## Section II. Contingency Combat Service Support Operations

### DEPLOYMENT

Brigade CSS for the deploying contingency force is provided by a DISCOM FAST. The team is tailored to satisfy the requirements of the supported brigade and is formed around a forward support maintenance company and a forward medical company. The DISCOM forms three echelons, one each to support the assault echelon, the follow-on echelon, and the rear echelon. Each is tailored to the mission.

**Assault Echelon.** This echelon consists of a portion or all of the FAST, as determined by the commander's concept of the operation. It is normally attached to the supported brigade during marshaling. This attachment remains effective during the assault phase. The FAST is tailored for the mission and can include elements from a forward maintenance company, medical company, and supply company. It can also include a detachment from the quartermaster airdrop equipment support company that can assist in the recovery and evacuation of airdrop equipment from the drop zone (DZ). The FAST may receive augmentation from corps based on mission needs.

**Follow-on Echelon.** Most of the DISCOM enters the AO in the follow-on echelon under the control of the DISCOM. Normally deploying by airland assault, the CSS follow-on echelon includes the remainder of the DISCOM HHC(-), a detachment from the quartermaster airdrop equipment support company, and a portion of the main support battalion (MSB). Remaining DISCOM units stay at the departure airfield in the rear echelon.

**Rear Echelon.** This echelon remains at the departure airfield or ISB and consists of elements not immediately required in the airhead to support the assault force. These elements include the remaining portions of the DISCOM MMC, MSB, quartermaster airdrop equipment support company, and the finance and personnel service companies (corps unit). Depending on the duration and nature of the operation, the rear echelon may be called forward and deployed into the AO after the lodgement is established.

### PLANNING CONSIDERATIONS

Brigades, battalions, and companies begin the logistical parallel planning process as soon as they receive a WO or instructions to implement an operation plan (OPLAN). The plan covers both support during combat and predeployment preparation. The part of the plan covering the predeployment phase includes supplying the unit, moving to the marshaling area, and conducting logistical operations in the AO.

A number of factors and considerations affect the logistical plan, including an analysis of the AO, the ground tactical plan, the anticipated duration of the operation, and unit strength.

**Basic Decisions.** For the logistical plan to progress in a timely manner, planners make basic decisions as early as possible. This allows all responsible agencies to prepare and execute plans for procurement and assembly of aircraft, supplies, equipment, and personnel. They decide on the following:

- What forces will be involved, how will they be organized, and what their principal objectives will be.
- What the tentative strength and composition of logistical units in the assault force will be.
- What type and amount of equipment should accompany the assault force.
- What initial supplies will be taken.
- What level of supplies will be maintained in the airhead.
- What airfields will be used for the landing of supplies.
- How long it should take to secure and organize airheads in the AO.
- Where rear bases to be used for supply purposes should be located.
- How available aircraft should be allocated for soldiers and supply.
- What evacuation policies should be set up.
- What capacity of the ISB should be maintained at forward air bases to facilitate supply.

Planners make detailed plans based on the basic decisions. The following considerations also affect the plan:

- How the desired quantities of supplies will be delivered to rear air bases at the proper time.
- How many, what size, and what type aircraft are available, and what are their loading characteristics.
- What material-handling equipment is available.
- What the distance is between rear air bases and landing areas.
- Facilities that are at the airhead include road network, storage facilities, and other facilities.
- How long the follow-on supply phase will go on before normal supply procedures are in effect.
- What quantities of supplies, equipment, and materials will be available within the proposed airhead for possible exploitation.
- If dedicated air MEDEVAC (fixed or rotary wing) is required and available.

## PHASES OF SUPPLY

During the early stages of a contingency operation, CSS operations mature at a pace dictated by the arrival of CSS assets into the AO. The nature of CONOPS demands that the bulk of initial forces to deploy are combat forces. There are three phases of supply in CONOPS—accompanying supplies, follow-on supplies, and routine supplies.

**Accompanying Supplies.** These include supplies taken into the airhead by assault and follow-on units. Accompanying supplies are issued to units before marshaling for early preparation before air movement and for delivery in the assault. They are carried into the assault area and include the supplies air-dropped with the deploying unit. Each unit receives and protects its three types of accompanying supplies—unit, force, and reserve supplies and are discussed in the following paragraphs:

- **Unit supplies.** These supplies include each soldier's basic combat load, basic loads of vehicular ammunition and other supplies, and prescribed loads of other classes of supply.
- **Force supplies.** These bulk supplies that the supporting units provide are retained at battalion or brigade. They include all classes of supply. The S4 of the deploying unit is responsible for controlling these supplies.
- **Reserve supplies.** These are additional supplies brought into the airhead under DISCOM control; they consist of the assault force reserve of Class III, Class V, selected items of Classes II and IV, and Class IX.

**Follow-on Supplies.** Follow-on supplies include all classes of supply; they are air-delivered after the unit has made its initial assault to help the unit operate until normal supply procedures can be set up. They are usually packaged, rigged, and stored at the beginning of the operation for immediate distribution on request. Quantities are based on the G4's estimate of the unit's daily requirements. The battalion S4 requests follow-on supplies for the battalion. Follow-on resupply is discontinued as soon as practicable. The two categories of follow-on supplies are—

- **Automatic.** These are delivered on a preplanned schedule once a day, beginning at a time based on the specific situation; they should be enough to sustain the deployed contingency force until routine supply is available. Automatic follow-on supplies are either airdropped to the unit or air-landed at a central supply point. Follow-on supply should not be scheduled for automatic delivery on the day an opposed-entry operation is to begin because assaulting units within the airhead should be fully occupied with seizing assault objectives, establishing the airhead, and recovering accompanying supplies.
- **On-call.** These are held in the departure area ready for immediate delivery to units on specific request. They include more of the items supplied by automatic follow-on, major items of equipment, and supplies that are not used at a predictable rate. The assault force determines the types and quantities of supplies to be held in on-call supply. Depending on the situation, on-call supplies can be prepackaged into loads by type or can be maintained in bulk pending request. Emergency on-call supplies must be delivered within 24 hours. Routine supplies are delivered on a flexible schedule 24 to 72 hours after the request.

**Routine Supplies.** These are requested and delivered by normal supply procedures. The DISCOM commander decides when routine supply deliveries should begin, depending on the tactical situation and supply status of the division.

## CLASSES OF SUPPLY

The following discussion provides information about the classes of supply and unique considerations for contingency forces.

**Class I.** This class includes meals ready-to-eat (MRE), tray pack, and A-type meals. Contingency units use MREs as the basic load and for follow-on supply. Tray packs and

A-type meals may be used later as the airhead is developed and the tactical situation allows. Personnel strength reports determine Class I requirements, thereby eliminating complicated unit ration requests.

**Class II.** This class includes clothing, individual equipment, tentage, hand tools, administrative and housekeeping supplies and equipment, and chemical decontaminants. Accompanying supplies include some Class II items. Follow-on and routine supply include small stocks of individual clothing and equipment while on-call follow-on supply includes major items of equipment as the situation dictates.

**Class III.** This class includes POL. Unit combat and utility vehicles are usually delivered to the airhead with fuel tanks three-fourths full to allow for expansion during airlift. Forecasts for POL are used by units to program delivery as part of the assault and follow-on supplies. Packaged POL and bulk POL supplies are used. Plans for POL should include retrograde movement of containers for refill.

**Class IV.** This class includes construction materials and all fortification and barrier materials. Units can only take a limited amount of Class IV into the objective area. Units exploit local resources.

**Class V.** This class of supply includes all ammunition. Planners must consider that, during the assault phase, ammunition tonnage is greater than the combined weight of all other supplies. Units take a basic load only. The amounts are expressed in the number of rounds for each weapon each day. Specified amounts of all types of ammunition for assault forces (enough for continuity of the combat operation) are provided follow-on supply. Follow-on resupply should be cross-loaded to offset possible loss of one type of item if aircraft are lost. Expenditure rates are based only on staff estimates, which must take into consideration the following factors:

- Degree of opposition to be encountered during and after the landing.
- Number and types of weapons landed with assault forces.
- Planned time of follow-on supply.
- Number and types of aircraft to be used.

**Class VI.** This class includes personal demand items, usually unavailable in the airhead, for sale or issue to soldiers and other authorized individuals. It should not be confused with the ration supplement and sundries pack. (The sundries pack has items necessary for the health and comfort of soldiers, such as essential toilet articles and confections. It may be available in the theater of operations for issue through Class I channels, pending establishment of adequate service facilities.)

**Class VII.** This class includes major end items. Certain items of this class can be retained for use in on-call resupply to replace those lost in combat or during delivery.

**Class VIII.** This class includes medical material, which is discussed with health services later in this chapter.

**Class IX.** This includes repair parts required for maintenance support of all equipment. Some critical repair parts deploy with the using unit in the assault phase. Maintenance units entering the airhead in follow-on operations carry prescribed load lists (PLL), shop stock listings, and designated items from the authorized stockage list (ASL). Additional techniques specific to light armor units are discussed later in this section.

**Captured Supplies and Salvage.** Units use captured or abandoned enemy materiel and supplies within the limitations prescribed by the commander. The use of captured equipment and materiel eases the logistical burden in the airhead by reducing the number of airframes needed in the early stages of the operation.

**Water.** Assault forces carry water into the objective area using filled canteens and the maximum amount of bulk water in containers such as 5-gallon water cans and water drums. They carry enough organic water to drink during travel to the airhead and for a short period of time while they are waiting there. Planners must ensure soldiers have enough water in the airhead. They should also determine the location of possible water supply points in the objective area. Soldiers carry water purification tablets in the event of contamination of local water.

## DISTRIBUTION OF SUPPLY

Supply and transportation units can accompany the assault echelon to recover assault supplies transported under control of the assault force and to establish necessary supply points. The assault force can use supply point distribution, unit distribution, or both to handle supplies. Throughput distribution bypasses one or more intermediate supply echelons to avoid multiple handling. Commanders choose this method whenever possible to deliver supplies from the rear echelon to the units in the airhead.

In the unit distribution method, the issuing agency transports supplies to the receiving unit's area. They can use ground transportation from supply points near DZs or airfields, or they can air-drop supplies directly to the using unit.

With supply point distribution, the receiving unit picks up supplies from a distribution point and moves them in organic transportation. Distribution points for essential combat supplies are positioned close to the soldiers to benefit from the security provided by the combat elements. This also prevents infiltrating hostile forces from cutting the supplies off from the receiving unit; it also shortens supply lines.

Supplies must be delivered to the airhead configured for easy handling. Limited CSS and transportation assets, as well as the tactical situation, affect supply distribution in the objective area. Multiple DZs must be selected, including sites close to the forward elements. Some supplies should be packed into container delivery system (CDS) bundles for expedient follow-on resupply.

## RESUPPLY BY AIR

Army and Air Force assets are used for both airland and airdrop delivery, although most Air Force deliveries are air-dropped. Airland has an advantage in that special equipment or rigging is not required. When airdrop is necessary, the Army furnishes the airdrop equipment and rigs the loads. The advantages of airdrop are the ability to place supplies in the immediate vicinity of the using unit and the capability to deliver a large amount of supplies in a short amount of time in the objective area. Airdrop rigging support for airdrop resupply comes from division and corps airdrop units.

**Preplanned Resupply.** Preplanned airdrop resupply can be automatic or on-call. Automatic airdrop resupply can be arranged for a designated time and place to support specific operations. On-call airdrop resupply uses prerigged and pre-positioned supplies that are arranged before an operation and delivered when requested by the supporting unit. To obtain a preplanned airdrop, units in the airhead request supplies and equipment from their DS unit in the FAST.

**Immediate Airdrop Resupply Requests.** Immediate airdrop resupply missions result from unanticipated, urgent, or priority requirements. Immediate requests for resupply missions must be flown faster than preplanned missions. Unless the JTF commander has allocated airdrop assets for strip alert or has otherwise kept airlift in reserve, immediate airdrop resupply requests are filled by preempting, diverting, or canceling lower priority preplanned missions.

**Helicopter Resupply.** Light forces use helicopters extensively to support CSS requirements. Light armor forces must deploy with sling-loaded equipment and train their personnel in slingload operations. There are two types of helicopters:

- Utility helicopters (UH). A UH is a general-purpose aircraft with limited carrying capability. It is used for such missions as transport of troops, cargo, or patients. Two Army helicopters are of this type; the UH-1H Huey can carry approximately 2,250 pounds externally, the UH-60A Blackhawk up to 8,000 pounds.
- Cargo helicopters (CH). The CH has the capacity for carrying greater weights and sizes than those carried by the UH. It can lift heavy, oversized loads, such as artillery pieces and ammunition. It can recover downed aircraft or vehicles. There are two CHs, the CH-47 Chinook and the CH-53E Super Stallion. The Chinook is the Army's primary CH. It can carry a maximum external load of 26,000 pounds. The Super Stallion is the primary CH of the USMC and USN and can lift up to 36,000 pounds on an external single-point cargo hook.

## MAINTENANCE

Light armor units must conduct efficient maintenance to ensure maximum and reliable availability of combat systems for the contingency assault force commander. Light armor units conduct maintenance in phases—predeployment, marshaling, and deployment. These phases take place in the objective area and after the expansion and buildup of the airhead.

**Predeployment Maintenance.** Predeployment maintenance includes normal scheduled maintenance under the SOPs of the light armor battalion at its home station. Maintenance assets are consolidated in the headquarters company of the light armor battalion under the direction of the battalion maintenance officer (BMO). Company maintenance teams (CMT) are organized for each company within the light armor battalion; the same procedures, outlined in FM 71-2, apply.

Special maintenance procedures may apply in contingency units prior to assuming a “most-ready” deployable status according to local SOPs. These procedures may include operational readiness inspections prior to a light armor company assuming most-ready status, live fires to confirm fire control accuracy, and other predeployment checks and services.

**Marshaling and Deployment.** To reduce maintenance requirements in the airhead, intensive maintenance is performed before departure. Organizational and DS maintenance support the marshaling unit as required. Contact teams are established to inspect and repair equipment during marshaling. The DMMC may direct the maintenance battalion to use the operational readiness float to fill critical combat requirements. Internal assets within the deploying light armor battalion may replace nonmission-capable equipment of the deploying light armor unit based on local SOPs and the commander's guidance

**Maintenance in the Objective Area.** Maintenance in the objective area during the initial assault and subsequent operations phase is performed by personnel organic to the battalions and to separate and attached companies and platoons. The amount of maintenance assets deployed is directly proportional to the amount of available space on aircraft delivering the assault force to the objective area and to the commander's priority of forces included in the initial assault. Page 8-9 discusses techniques commanders priority of forces included in the maintenance assets with the assault force and to maximize the number of combat systems available in the objective area.

The complete forward support company and other designated individuals from the light armor battalion maintenance platoon arrive in the objective area with the follow-on echelon as aircraft availability permits. Forward support company personnel establish the FAST to

provide DS maintenance of primary weapon systems and communications equipment. Maintenance personnel from the light armor battalion may augment the FAST maintenance section or may link up with and attach to the deployed light armor platoons or companies. To maintain the maximum number of combat systems available to the commander, they use battle damage assessment and repair (BDAR) and cannibalization procedures for severely damaged or inoperable systems.

**Expansion and Buildup of the Airhead.** During this phase, the remaining DS and organizational level maintenance elements are deployed. As the force builds, so do the maintenance assets, based on the aircraft flow into the airhead and the commander's priorities. The light armor battalion deploys tailored maintenance assets to meet the needs of the deployed force. The following paragraphs outline techniques for deploying maintenance assets along with the assault force.

## TECHNIQUES FOR DEPLOYING LIGHT ARMOR COMBAT SERVICE SUPPORT IN THE ASSAULT FORCE

This discussion contains methods in which the TF commander can deploy an interim support package which can support a small light armor unit until the light armor unit's parent unit CSS assets or additional divisional support units arrive in the AO. This support can be deployed in these forms:

- Critical repair parts package.
- CSS contact team.
- CSS package.

**Critical Repair Parts Package.** Deployment packages of small critical repair parts can be easily consolidated by unit PLL personnel and crated for transport in small packages. Packages will include only those parts that can be used to maintain combat readiness of a platoon- to company-size unit for a short period of time. The unit will typically be part of the assaulting unit or initial deploying unit. Repair parts included in the package should be only those that can be installed by vehicle crews under combat conditions without the aid of lifting equipment or unit level repair apparatus. Examples include (but are not limited to)—

- Air and fuel filters with seals.
- Communications equipment, such as cables and control boxes.
- Track shoe and blocks, center guides, and wedge bolts.
- Roadwheels and suspension parts.
- Relay switches.
- Batteries and battery connectors.
- Small arms repair parts.
- Hardware fasteners.
- Sling load sets.
- Firing probes (spare fire pins).

## FM 17-18

Parts packages can be transported to the AO in the following ways:

- Via the same aircraft used to transport the deploying combat vehicles.
- By air delivery as part of accompanying or follow-on supply.
- By slingload operations (if applicable).
- On a command-approved support vehicle deploying with the opposed entry or assault echelon.

**CSS Contact Team.** The CSS contact team gives the TF commander a relatively small team with the expertise to—

- Conduct unit level repairs on combat vehicles.
- Relieve the platoon leadership of much of the CSS coordination requirement during critical early hours of an opposed entry operation.
- Provide technical expertise on the weapon system not organic to the light infantry unit.
- Provide a liaison to the infantry battalion staff for both CSS and employment of the light armor force.
- Provide support despite changing task organization.
- Serve as an advance party for follow-on forces from the light armor battalion.

The CSS contact team can provide limited logistical support during the force buildup in the operations stage of a CONOP. It is not designed for extended operations. It provides key support during the most critical stages of a CONOP during the opposed entry or assault phase until adequate traditional CSS assets arrive in the AO in later phases. The team works for the light infantry TF XO or S4. As the remaining CSS assets flow in from the home station, the team chief can take control of those assets and put them to use immediately. The team eventually grows into a traditional configuration as all the assets arrive into the AO. The CSS contact team should, as a minimum, be composed of—

- Team chief (company XO, 1SG, or CMT leader).
- Turret mechanic.
- Hull mechanic.
- Communications equipment repairman.
- HMMWV.
- Critical repair parts package.

**CSS Package.** The CSS package provides the TF commander with a readily available option for operating with light armor deployed for a CONOP of short duration. The CSS package provides the minimum logistical needs of a light armor company when deployed as part of a light infantry TF. A light infantry battalion or brigade does not possess the transportation or recovery assets required to support a light armor company. The CSS package consists of (but is not limited to)—

- Team leader (company XO or 1SG).
- Company maintenance slice.
- Supply sergeant.
- Class III truck.



- Class V truck.
- Recovery vehicle with repair parts package.
- HMMWV for C2.

The light armor company will go with its organic slice of support assets when organized with a light infantry TF. Composition of the package includes recovery, cargo, fuelers, repair parts package, and maintenance. It can be tailored to meet specific requirements based on METT-T. The assets will come from the light armor battalion; they will deploy in echelons and in order of priority along with a deploying contingency force of up to brigade size. The large amount of bulk fuel and the size and weight of ammunition used by light armor would seriously stress the limited transportation assets available to a light infantry unit.

**Escalation of Conflict.** A CONOP that begins as an operation other than war may escalate to war; this requires the deployment of additional forces, including heavy armor and mechanized units. In this situation, the contingency force most likely is rapidly reinforced with the majority of its parent unit based on the direction of the joint staff. Remaining divisional CSS assets are prioritized and deployed to the AO sequentially as part of the division air flow or on ships.

As the force grows, the light armor unit evolves logistically and may begin to function as a battalion. The initial CSS support elements may revert back to the control of the light armor battalion once light armor CSS C2 elements arrive in the AO.

## Section III. Operations

### TASK FORCE TRAINS

The organization of trains varies according to the mission and support assets assigned to the TF. Trains may be centralized in one location (unit trains), or they may be echeloned in three or more locations (echeloned trains). Unit trains are formed in AAs and during extended tactical marches. Forming unit trains eases coordination and control and increases trains security. Unit trains are controlled by the S4, with the assistance of the S1. The HHC commander moves with the BSA to maintain coordination with the FSB and the brigade rear CP.

The field trains are usually in the BSA and are controlled by the HHC commander. Generally, field trains include the field trains CP (HHC CP), personnel and administrative center (PAC), mess sections, company supply sections, and remaining elements of the maintenance and support platoons that are not forward.

The BSA is that portion of the brigade rear area occupied by the brigade rear CP, FSB, TF field trains, FA field trains, and various unit-level support elements of other divisional troops. The BSA is usually 20 to 30 kilometers behind the FLOT. CSS assets in the BSA include elements from the FSB, maneuver unit field trains, and selected corps (corps support command [COSCOM] ) resources, as required. Brigade CSS is managed by the brigade S4 in coordination with the FSB commander.

The TF CSS assets are normally echeloned into company trains, battalion combat trains, and battalion field trains. The combat trains are organized to provide immediate critical support for the combat operation. Field trains are normally in the BSA under the control of the HHC commander, who coordinates with the brigade S4 and FSB commander for security and positioning. The composition of the combat and field trains varies according to the factors of METT-T.

## COMBAT TRAINS

The combat trains include the combat trains CP, the unit maintenance collection point (UMCP), the battalion aid station (BAS), the decontamination vehicle, some vehicles for supply Classes III and V, some supporting elements from the FSB, and the unit ministry team. The combat trains are controlled by the S4, assisted by the S1. All elements are tied to the combat trains CP by landline and operate on the A/L net.

The combat trains are generally 1 to 2 kilometers from the main CP. They should be close enough to the FLOT to be responsive to the forward units but out of range of enemy direct fire. The combat trains can expect to move frequently to remain in supporting distance of the combat elements (normally 4 to 10 kilometers). Factors governing positioning of the combat trains include the following:

- Communications between the combat trains CP, main CP, field trains CP, brigade rear CP, and forward units are required.
- Cover and concealment from both air and ground observation are desirable.
- The ground must support vehicle traffic.
- A suitable helicopter landing site should be nearby.
- Routes to logistic release points (LRP) or to company positions must be available.
- Movement into and out of the area must not be restricted.

BUAs are good locations for trains. They provide cover and concealment for vehicles and shelters that enhance light discipline for maintenance. Battalion train elements should occupy buildings near the edge of the BUA to avoid being trapped in the center and to provide easy access to MSRs.

The UMCP is established by the BMO to provide forward maintenance support to the TF. It is normally located in the combat trains or, separated but adjacent to the combat trains.

## COMPANY TRAINS

The most forward CSS elements are the company trains. The medical evacuation team (routinely attached to the company) and the CMT tracked vehicles, when forward, operate from the company trains. The company 1SG positions these elements, supervises the medical evacuation team, and establishes priority of work for the CMT.

In echeloned trains, the company supply sergeant usually operates from the field trains. Coordination between the company supply sergeant and the 1SG is conducted through the combat trains CP to the HHC commander over the A/L net; it is supplemented by face-to-face coordination during logistics package (LOGPAC) operations.

During combat operations, the company habitually operates with the maintenance and medical teams forward (company combat trains). The remainder of its CSS elements operate from the battalion combat trains, UMCP, or the field trains in the BSA. The 1SG is responsible for all of the company trains, but directly supervises the company combat trains from a survivable vehicle (maintenance M113). The supply sergeant is the 1SG's principal assistant; he supervises the company's assets in the battalion field trains.

The company trains will normally operate about 500 to 1,000 meters or one terrain feature to the rear of the company team. They provide immediate response for recovery, medical aid, and maintenance. This allows maintenance and other essential CSS functions to be performed in covered and concealed positions behind the FLOT.

Support during the battle will be limited primarily to medical and maintenance activities. Emergency resupply is performed by the 1SG when required. During a battle, whether defensive or offensive, the 1SG continuously monitors the company command net and send medical and maintenance support forward to the platoons as required. He keeps the combat trains CP informed continuously, either by radio or messenger.

**Trains Security.** CSS elements behind the FLOT must be prepared to defend themselves against guerrillas and partisans, forces that have broken through or bypassed the defense, and enemy air assault and airborne insertions.

The S4 is responsible for trains security when operating in a unit trains configuration. When trains are echeloned, the S4 is responsible for securing the combat trains, and the HHC commander is responsible for securing the field trains. The HHC commander coordinates with the FSB commander and brigade S4 to integrate the TF field trains into the BSA defensive plan. In all trains areas, a perimeter defense is normally planned and rehearsed immediately upon occupying a new position before normal support activities commence. Elements in the trains are assigned a specific sector to defend. Mutually supporting positions that dominate likely avenues of approach are selected for vehicles armed with heavy machine guns. Reaction forces and OPs will be made based on the unit SOP. To enhance security, an alarm or warning system is arranged. Sector sketches, fire plans, and obstacle plans should be prepared. Rehearsals are conducted to ensure that all personnel know the part they play in the defensive scheme. The officer in charge (OIC) at each location establishes a shift schedule for operations and security on a 24-hour basis.

**Command, Control, and Communications.** CSS C3 is the responsibility of the TF XO. The S4 routinely coordinates all logistics operations based on the XO's guidance. C3 facilities are the combat trains CP and the field trains CP.

The combat trains CP includes the S4 CP carrier (M577) with adequate cross-trained S1 and S4 personnel to ensure continuous operations. The combat trains must stay abreast of the tactical situation and current task organization. They must monitor the TF command net to identify CSS requirements and to receive requests, reports, and requirements from TF subordinate elements. Subordinate elements' requirements are analyzed, consolidated, and forwarded to the field trains CP or to the appropriate supporting agency. The HHC commander coordinates and directs elements in the field trains to take action to meet the forward units' requirements.

The field trains CP, established by the HHC commander, is the coordination and control center for the support platoon, PAC, maintenance platoon (-), and the battalion and company supply sections. Personnel from these sections operate the field trains CP under the supervision of the HHC commander. The HHC commander coordinates all requirements for TF organic and attached elements with all units in the BSA and parent units, as necessary.

Communications are critical to expedite the CSS effort. Unit 1SGs must report their losses and requirements as soon as they become known. The combat trains CP receives and analyzes these requirements and notifies the field trains or dispatches resupply vehicles from the combat trains as needed. When radio use is not possible, messages are sent with resupply or evacuation vehicles. The combat trains CP maintains positive control of vehicles moving forward to the LRPs. The TF sends reports to the brigade rear CP in the BSA. TF SOP establishes procedures for resupply without request in the event communications fail.

At TF level, CSS communications may be by any combination of FM radio, MSE, courier, or wire. The A/L radio net is used for most CSS traffic. For lengthy reports, use messenger, wire, or MSE.

The combat trains CP is the NCS for the A/L net. The S1, S4, HHC commander, BMO, support platoon leader, medical platoon leader, company 1SGs, and others (as required) operate on the TF A/L net. The combat trains CP also operates on the division or brigade AIL net based on command and support relationships.

## Section IV. Supply and Resupply Techniques

### CLASSES OF SUPPLY

**Class I.** This supply class includes subsistence and gratuitous health and welfare items. These considerations apply:

- Class I is automatically requested at brigade based on the daily strength report. The combat trains CP forwards the strength report to the field trains CP, which in turn instructs the mess section to prepare the rations. When a specific item is required, the S4 can submit a separate subsistence request through the field trains CP to the supply company of the FSB.
- The support platoon draws subsistence from the FSB supply company's Class I point in the BSA. Raw subsistence items are issued through supply channels. Rations are usually prepared in the field trains and delivered to the companies and attached units as part of the LOGPAC.
- A three-to-five day supply of MRE rations is stored on combat vehicles. Meals from this combat load are eaten only when daily Class I resupply cannot be accomplished. Frequency of unit feeding and use of A or B rations depend on tactical situations. If possible, troops should receive at least one hot meal per day. Hot rations should be packed in platoon-size portions rather than consolidated as company-size packages.
- Water is not a Class I supply item, but it is normally delivered with Class I. The HHC commander or support platoon leader coordinates with the FSB to pick up water from the water supply point. Water is delivered to the units using 400-gallon water trailers. Also, forward water points can be tested and approved by the battalion surgeon. During desert operations, each vehicle in the TF should carry *at least two* 5-gallon water cans to be refilled or exchanged for full cans during Class I resupply and LOGPAC operations. When necessary, the TF's 400-gallon water trailers can be augmented by collapsible water containers (common table of allowances items).

**Class II.** This supply class includes clothing, individual equipment, tentage, hand tools, administrative and housekeeping supplies and equipment, and chemical defense and decontamination items. These considerations apply:

- When Class II items are lost, destroyed, or worn out, unit supply sergeants send replacement requests through the S4 to the FSB.
- The S4 supply section or company supply sergeant picks up Class II items from the FSB supply company in the BSA and delivers them to the unit during LOGPAC operations. Expendable items such as soap, toilet tissue, insecticide, clothing, and TA-50 are provided during the LOGPAC.

**Class III.** This supply class covers all types of POL, including petroleum fuels, lubricants, hydraulic and insulating oils, preservatives, liquids, and gases; bulk chemical products; coolant, deicer, and antifreeze compounds; components and additives of petroleum and chemical products; and coal. These considerations apply:

- The brigade S4's POL forecasts form the basis for division and corps stockage levels. POL is normally obtained by the battalion transportation section from the supply company's Class III supply point in the BSA. Empty fuel-handling vehicles and containers presented at a supply point are sufficient to obtain POL without a formal request. In exceptional cases, FSB fuel vehicles deliver to the combat trains area, or helicopters may deliver POL to the unit in 500-gallon collapsible drums. POL are requested through the S4 and handled in the same manner as Classes II, IV, and VII supplies.

- Company requests are not required for POL resupply. POL tanker vehicles will move forward with each LOGPAC. Packaged POL products are carried on each tanker vehicle. Requests for unusual requirements are submitted to the combat trains CP. Nonscheduled or emergency resupply of POL will be made by POL tankers stationed in the combat trains for that purpose.

**Class IV.** This supply includes construction materials, such as installed equipment and all fortification and barrier materials. These considerations apply:

- These are items for which allowances are not prescribed. The TF submits requests for Class IV items through the FSB to the DMMC.
- Requests for intensively managed Class IV items often require command approval. In that case, requests go through command channels to the division or corps G3 for release approval. Construction and fortification materials are normally delivered by DISCOM or COSCOM transportation and are carried as far forward as possible to reduce handling. Combat vehicles carry small amounts of these materials into the battle. These combat loads can consist of wire, pickets, and lumber as designated by unit SOP.

**Class V.** This supply class includes ammunition of all types (including chemical, radiological, and special weapons), bombs, explosives, mines, fuzes, detonators, pyrotechnics, missiles, rockets, propellants, and other associated items. These considerations apply:

- Class V supply is based on a required supply rate (RSR) and a controlled supply rate (CSR).
- RSR is the amount of ammunition, usually expressed in rounds per weapon per day, estimated to be required to sustain operations, without restriction, for a specified period. It is developed by the brigade S3 based on data from FM 101-10-1/2 and the situation. It is submitted through command channels.
- CSR is the rate of ammunition consumption that can be supported for a given period considering availability, facilities, and transportation. For ammunition fired from weapons, it is expressed in rounds per weapon per day. For other Class V items, it is expressed in various units of measure for specific items (for example, a specific amount per day or per week). The CSR for a given period may well be less than the RSR. The division ammunition officer (DAO) in the DMMC manages ammunition resupply by referring to CSRs for different types of ammunition.
- The TF receives ammunition from the ammunition transfer point (ATT) in the BSA, which is operated by the FSB supply company. A backup ATP is positioned in the division support area (DSA), operated by the corps ammunition company. If required, corps and division trucks and helicopters can deliver ammunition directly to the battalion combat trains, provided sufficient reaction time and ammunition are available.
- When ammunition resupply is required, a request (DA Form 581) is prepared by S4 or support platoon personnel for an amount based on unit expenditures (or projected requirements in the case of caches) and the current CSR. The request is validated by the DAO or his representative in the BSA, based on the CSR and the unit's previous consumption. The ammunition is then picked up and transported to the field trains, where it remains loaded until needed for company resupply.
- When companies request Class V resupply, the support platoon dispatches ammunition vehicles to an LRP, where a guide from the company guides them to the company area. Routine resupply of Class V is accomplished by LOGPACs.
- Requests for nonscheduled or emergency resupply of Class V are sent to the combat trains CP. Resupply is made by ammunition vehicles positioned in the combat trains for that purpose.

**Class VI.** This supply class includes personal demand items, such as candy, cigarettes, soap, and cameras (nonmilitary sales items). Some items in sundry packs are also Class VI items. These considerations apply:

- Requests for Class VI support are consolidated and submitted by the S1 through supply channels when a post exchange (PX) is not available.
- Resupply flow is the same as for Class I resupply.

**Class VII.** This supply class includes major end items such as launchers, tanks, mobile machine shops, vehicles, and organizational tool sets. Large items may be delivered by COSCOM directly to the TF trains. Smaller items are picked up by the support platoon at the distribution point in the DSA or BSA.

**Class VIII.** This supply class includes medical materiel, including repair parts peculiar to medical equipment. These considerations apply:

- Medical supplies are obtained by the medical platoon from the medical company in the BSA. Normally, these supplies are distributed by evacuation vehicles returning from the BSA to the aid station and from the aid station to the company team.
- The medical platoon leader coordinates with the S4 for additional supplies as required or based on the S1 loss estimate and projection for mass casualty situations.

**Class IX.** This supply class includes repair parts and components, including kits, assemblies, and subassemblies (repairable and nonrepairable) that are required for maintenance support of all equipment. These considerations apply:

- The TF's stock of repair parts is based on a combat PLL. The maintenance platoon's administration section manages repair parts.
- Repair parts are issued based on a specific request or by repairable exchange (RX). The TF obtains repair parts from the Class IX supply point in the BSA. Parts are moved forward during routine LOGPAC operations or as required to the UMCP. The maintenance platoon requests Class IX items (minus RX), quick supply store (QSS), and major Class IX subassemblies such as engines and transmissions by submitting single line requests (DA Form 2765) to the maintenance company of the FSB. Low-dollar-value and high-demand parts (light bulbs, wiper blades, common bolts and nuts) are obtained without formal requests from the repair parts QSS, operated by the FSB maintenance company. RX for selected repairable items (to include components and subassemblies) is handled on the basis of a simple exchange of the unserviceable item, with an attached DA Form 2765-1, for a serviceable item. If an unserviceable item is not available for exchange, the unit must submit a request (DA 2765-1). In some cases, controlled exchange and cannibalization may be required to obtain Class IX supplies.

**Class X.** This supply class includes materiel to support nonmilitary programs such as agriculture and economic development (not included in Classes I through IX). These considerations apply:

- Class X items are requested, obtained, and delivered by the S4 based on requirements from the civil military and/or operations channels.
- Specific instructions for request and issue of Class X supplies are provided by division or higher.

## SUPPLY PROCEDURES

The supply system provides many types of supplies to the TF. The most important of these are ammunition, POL, and repair parts for weapon systems. To ensure continuous support, supplies are provided as far forward as the tactical situation will permit.

In addition, the TF maintains some combat-essential supplies and repair parts. These are called combat loads, basic loads, and PLLs. The minimum stockage level is normally directed by division or higher. The purpose of having these loads is to enable a unit to sustain itself in combat for a limited period should there be an interruption in the resupply system. This period normally is 15 days for general supplies and 2 to 3 days for supply Classes I, III, and V.

The TF uses the following three methods to replenish its supply stock:

- **Supply point distribution.** The TF, using organic transportation, goes to the distribution point to pick up supplies. This is the normal method used by the TF support platoon to pick up supplies.
- **Unit distribution.** Supplies are delivered to a unit by transportation assets other than its own. The TF uses unit distribution to resupply its subordinate elements. Routine resupply occurs either on a daily basis or as the tactical situation requires.
- **Throughput distribution.** When feasible, supplies are shipped directly from the issuing agency as far forward as possible, provided the receiving unit has the material handling equipment (MHE) necessary to handle the shipping containers. This means some supplies may be issued directly to the TF from COSCOM or even theater army level, especially supply Classes III, IV, VII, and IX. This issue will most likely occur no farther forward than the field trains. However, the TF uses the established requisition channels, regardless of the issue method chosen by higher headquarters.

The S4 section is organized to process supply requests and to receive, issue, and temporarily store supplies. Distribution priorities for items in short supply are determined by the commander based on recommendations by the S4 and the operational requirements of the TF.

**Supply at the Company Level.** The supply sergeant is responsible for obtaining and delivering supplies to the company. He delivers small items out depending on the assets of the support platoon to deliver bulky or high-expenditure items. Priorities for delivery are established by the company commander, but the demands of combat will normally dictate Classes I, III, IV, V, VIII, and IX supplies as most critical to successful operations. Company-level considerations for these supply classes include—

- **Class I.** MRE are stocked on board each vehicle in a basic load prescribed by SOP (usually three to five days). MRE and water are delivered daily to the company from the field trains by the supply section. Hot meals are served when possible. Water is a critical item and must be replenished daily, especially when the unit is wearing chemical protective clothing. Rations are automatically requisitioned and issued by the S4 section based on daily strength reports sent to the S1 by the companies.
- **Class III.** Class III bulk and packaged products are delivered to the company by the support platoon. Resupply is accomplished from the battalion field trains as requested by the 1SG. If the tankers are attached to the company, they will return to the Class III point in the BSA for refill as soon as the company has been refueled. Small amounts of packaged products (hydraulic fluid and lubricating oil) are stored on each combat and tactical vehicle. These are replenished from stocks on the bulk fuel tankers.

- Class IV. Class IV items are requested through command channels. Basic loads of materials required for the construction of individual fighting positions should be a part of each vehicle's load plan; they are specified in the company team SOP.
- Class V. Class V resupply is based on a report of expenditures submitted to the combat trains CP by the 1SG. The ammunition is delivered to the company by the LOGPAC. This ammunition will be pre-positioned (in a defense or delay) or distributed as part of tailgate or service-station resupply.
- Class VIII. Class VIII items are provided by the medical platoon. Requests are submitted to the BAS by the medics. When the medical supplies are received, they are issued to the medics by the aid station or during ambulance exchange.
- Class IX. Class IX items are requested through the PLL clerk. They may be delivered to the LOGPAC or the maintenance platoon, or the maintenance team may have to return to the UMCP to pick them up.
- Maps. Maps are requested from the battalion S4.

**Supplies to Support Night Operations.** While all classes of supply are affected by night combat, Classes I and III present the most significant problems. Class I supply points and kitchens must operate around the clock. At night, vehicles tend to operate in a lower gear or idle for longer periods, thereby requiring more fuel and oil.

Other items of supply for night operations vary in demand depending on weather, terrain, and type of operation under consideration. For most tactical operations at night, units must expect an increased demand for—

- Engineer tape and stakes.
- Tarpaulin shelters.
- Night-vision devices (NVD) batteries.
- Flashlights and filters (green, blue, red, and infrared).
- Luminescent tape and paint.
- Red lens goggles.
- Replacement bulbs.
- Replacement night observation devices (NOD).
- Chemical lights.

## RESUPPLY

Resupply operations can be described as routine, emergency, and prestock. Each method is developed in the unit SOP and rehearsed in training. The actual method selected will depend on METT-T.

**Routine Resupply.** Routine resupply operations are the regular resupply of Classes I, III, V, and IX items, mail, and any other items requested by the company. Routine resupply takes place at least once daily. Periods of limited visibility are best for resupply, if possible. Resupply of Class III takes place at every opportunity. M1-series tank units in offensive operations routinely require refueling twice each 24 hours.

The LOGPAC technique is a simple and efficient way for routine resupply operations. A LOGPAC is a centrally organized resupply convoy originating at the TF field trains. LOGPACs should contain all anticipated supplies required to sustain the company for a



specified time, usually 24 hours or until the next scheduled LOGPAC operation. Company and battalion SOPs specify the exact composition and march order of the LOGPAC.

**Emergency Resupply.** Occasionally, as a result of combat, the company team may have such an urgent need for resupply that it cannot wait for a routine LOGPAC. Emergency resupply may involve Classes III, V, and VIII; NBC equipment; and on rare occasions, Class I. The TF will usually use support platoon and medical assets in the TF combat trains to conduct emergency resupply of company teams. Because it often occurs while in contact with the enemy, special techniques must be considered. When the platoons are under fire, limited supplies can be brought forward to the closest concealed position, where the tailgate method may be used. Individual fighting vehicles drop back to resupply at the direction of the platoon leader, then return to fight. For resupply during a lull in combat, the service-station method may be appropriate.

**Pre-positioning Supplies.** Pre-positioning supplies is required in most defensive operations. Normally, only Class V supply items are pre-positioned. The location and amount of pre-positioned ammunition must be carefully planned, and each vehicle commander must be informed. All leaders down to TC and squad leader verify the locations of the sites during their reconnaissance and rehearsals. Pre-positioning considerations include the following:

- Pre-positioned ammunition is on pallets, preferably in covered, protected positions.
- Pre-positioning frees cargo vehicles to bring more ammunition forward.
- The possibility of capture or destruction of pre-positioned ammunition is a risk for the company. The company cannot guard pre-positioned sites with the manpower available.
- Pre-positioned ammunition must be far enough away from vehicles and individual fighting positions that its destruction will not cause friendly vehicle or personnel casualties.
- Pre-positioning of fuel is difficult. It requires covered sites separate from ammunition, as well as additional equipment, including fuel transfer pumps and drums, blivets, and 5-gallon cans in quantity.

## BATTALION LOGISTICS PACKAGE

The most efficient resupply of a forward TF is accomplished by the LOGPAC, a method in which resupply elements are formed on the basis of logistics requirements of the unit. LOGPACs are organized in the field trains by the company supply sergeant under supervision of the HHC commander and the support platoon leader. LOGPACs are organized for each company team in the TF and moved forward for at least a routine resupply. When possible, all LOGPACs move forward as a march unit under the control of the support platoon leader. Special LOGPACs are organized and dispatched as required by the tactical situation and logistical demands.

The TF staff, under the guidance of the XO, must plan and coordinate LOGPAC operations in detail to ensure that they fully support the commander's tactical plans.

**LOGPAC Composition.** The TF SOP will establish the standard LOGPAC. Normally, a company team LOGPAC will consist of the following:

- Unit supply truck. This vehicle contains the supply Class I requirements based on the ration cycle, normally one hot meal and two MRE per man. The supply truck tows a water trailer and carries some full water cans for direct exchange. In addition, the truck carries any Class II supplies requested by the unit, incoming mail, and other items required by the unit. The truck may also carry replacement personnel and new or repaired equipment.
- POL trucks. Bulk fuel and packaged POL products are on these vehicles.

- Ammunition trucks. These vehicles contain a mix of ammunition for the weapon systems of the company team. Unit SOP establishes a standard load; reports and projected demands may require changes to this standard load.
- Vehicles for security or carrying additional supplies and personnel. These vehicles join the LOGPAC as coordinated by the support platoon leader and supply sergeant. They will also include returning combat vehicles.

**LOGPAC Procedures.** After the LOGPAC has been formed, it moves forward under the control of the supply sergeant, who requires a radio for control purposes. The support platoon leader may organize a convoy for movement of all LOGPACs under his control, or he may dispatch unit LOGPACs individually. The convoy may contain additional vehicles, such as a maintenance vehicle with Class IX supply to move to the UMCP, or an additional ammunition or fuel vehicle for the combat trains. The LOGPACs move along the MSR to an LRP, where the unit ISG or a unit guide takes control of the company LOGPAC. When the unit supply sergeant moves his LOGPAC to the LRP, he must know the MSR and be in radio contact (if he has a radio available) with the combat trains or HHC CP. Maintenance assets from the UMCP may join the company team LOGPAC at the LRP, if needed forward.

From the LRP, the company ISG or guide controls the LOGPAC and conducts resupply as described in FM 71-1. The unit ISG informs his supply sergeant of requirements for the next LOGPAC. The supply sergeant collects personnel (including KIAs and EPWs) for movement to the rear and outgoing mail and equipment for movement to the field trains. The LOGPAC then follows unit SOP and returns to the LRP or to the field trains.

LRP locations are determined by the S4 based on the tactical situation. Normally, two to four LRPs are planned. LRPs, as well as the MSR and combat trains and field trains locations, are included on the operations overlay, if possible. If not, they are on a CSS overlay. The combat trains CP notifies subordinates and the field trains CP in advance which LRPs will be used. The LOGPAC convoy's arrival time at the the LRP and the length of time it remains are normally established by SOP. For example, the SOP may call for an LRP time of 1800 hours to 2400 hours daily. This indicates that the LOGPAC convoy arrives at the LRP not later than 1800 hours. The unit must meet its LOGPAC, complete its resupply, and return the LOGPAC to the LRP not later than 2400 hours. If the tactical situation dictates otherwise, the S4 must determine the time and notify units accordingly. Subordinates must ensure that the resupply vehicles are returned to the LRP as soon as possible so they can return to the field trains and begin preparation for the next mission. If the LOGPAC cannot be completed on schedule, the combat trains CP must be notified by the ISG or XO.

At least one senior representative from the combat trains (S4, S1, or NCO) should be present at the LRP. He meets with the unit ISG and support platoon leader to coordinate logistical requirements and to ensure the LOGPAC release and return takes place efficiently. The battalion XO may also attend this meeting to assist in the CSS coordination for the TF. A brief meeting is normally held immediately before the ISG picks up his LOGPAC. Coordination may include—

- Changes in logistical requirements reflecting any last-minute task organization.
- Receiving hard-copy reports on personnel, logistics, and maintenance from the ISGs.
- Firsthand updates on the tactical situation and logistical status.
- Delivering and receiving unit mail and distribution.

The company supply sergeant or support platoon leader moves the LOGPAC from the LRP back to the field trains. The supply sergeant and support platoon leader then begin organization of the next LOGPAC.

The HHC 1SG coordinates and supervises resupply of the scout and mortar platoons, the main CP, combat trains, and attached support units. He operates primarily from the field trains. The following considerations apply for resupply of these elements:

- The platoon sergeant of these elements must submit a timely logistics status (LOGSTAT) report to the combat trains CP to ensure timely and accurate resupply. The most desirable method of resupply is to form small LOGPACs for these elements, with the platoon sergeant picking them up at the LRP in the same manner as a company 1SG. Attachments larger than a platoon must come to the TF with CSS vehicles, on which LOGPACs can be built.
- In some cases, the HHC 1SG will deliver the LOGPAC to the main CP, combat trains, and scout and mortar platoons. Attachments may receive resupply at one of these locations.
- Another option is for attachments to be resupplied at a nearby company team LOGPAC. The S4 coordinates this resupply *before* the LOGPACs are dispatched.
- Resupply operations for the scout platoon pose several unique problems. Special procedures may be necessary to resupply the scout platoon, including—
  - Resupplying the platoon by having each track pull off-line individually and move to a resupply site. This method may be feasible when the platoon is performing security for a stationary force.
  - Resupplying the platoon near the combat trains as the platoon repositions between missions.
  - Designating one Class III supply vehicle in the combat trains to fuel the platoon on short notice (opportunity refueling).

Units in DS of or OPCON to the TF are responsible for the resupply of their elements operating forward with the TF, except for the following:

- The ADA battalion commander coordinates for the TF to resupply DS ADA units with some classes of supply. This may be directed in higher headquarters SOPs and usually includes supply Classes I, III, V, and IX (common items).
- The TF provides engineer materials (supply Classes IV and V) to supporting engineer units. Additionally, engineer units supporting the TF should receive Classes I, III, V, and IX supply to the maximum extent possible.

The parent unit S4 or the company commander of the supporting element coordinates with the TF S4 or HHC commander on resupply of the forward elements. Normally, the supporting units' resupply elements assemble in the BSA and move to the TF field trains area. The HHC commander then dispatches these resupply elements forward, along with the TF LOGPACs, to the LRP. At the LRP, the platoon sergeant of the forward supporting element takes control of the resupply element. These resupply elements maintain contact with the combat trains CP while forward in the TF area. If coordinated between the supporting parent unit and the TF, the resupply of these forward elements is directly managed by the TF. The parent unit must provide the additional logistical assets necessary to supplement the TF's capabilities. No matter how support is coordinated, any element within the TF AO must be under the TF commander's control or at least remain in contact with the TF combat trains CP to avoid interfering with TF maneuver.

**Other LOGPAC Considerations.** Planning, preparation, and execution for the LOGPAC system must be conducted as with any other combat operation. The following considerations apply:

- **Planning.** The LOGPAC operations plan must take into consideration requirements of the company. Rehearsals must be conducted for route reconnaissance, LOGPAC formation, security operations during movement, and reactions during the convoy. The support platoon leader also needs to ensure that procedures are developed for lost vehicles, maintenance problems occurring during the movement, and changes to the mission, especially if the LOGPAC must wait along the supply route for the tactical situation to fully develop before resupply takes place. Refer to Chapter 4 for convoy security operations.
- **Preparation.** The support platoon leader and company supply sergeants, supervised by the HHC commander, must ensure all items necessary in the forward area are positioned in the LOGPAC. This includes the resupply vehicles and repaired or replacement combat vehicles that are being sent forward. The HHC commander will also ensure that wheeled recovery assets, if they are available, are placed at the rear of the convoy. He also needs to determine the tactical status of the forward elements, to include the tactical situation from the BSA through the battalion area. This information will allow the support platoon leader to brief the supply sergeants and drivers on situations they may encounter during movement and subsequent resupply operations. This could include minefield locations along the route of march, tank ditches, terrain considerations, NBC contaminated areas, and possible changes to the plan due to changes to the tactical situation.
- **Execution.** After the rehearsals and preparation are complete, the support platoon leader must control the LOGPAC from the field trains site to the LRP. He needs to ensure that radios are interspersed throughout the LOGPAC convoy to allow him to maintain control of the convoy. He needs to be made aware of any situation that develops and must issue instructions to handle the situation. The HHC 1SG can be invaluable in assisting the control of the entire convoy.

**Company LOGPAC Resupply.** Company supply sergeants assemble their LOGPACs under the supervision of the support platoon leader or HHC commander in the battalion field trains. Replacements and hospital returnees move to the company location on LOGPAC vehicles as required. Once the LOGPACs are prepared for movement, the supply sergeant will tactically move them as part of the TF resupply convoy led by the support platoon leader. In emergencies, a company LOGPAC may be dispatched individually to meet the 1SG at an LRP. This technique is not recommended because the LOGPAC is very vulnerable to attack, loss of communication, and disorientation when moving by itself.

The TF LOGPAC convoy is met at the TF LRP by company 1SGs, representatives from the combat trains CP and UMCP, and specialized separate platoon sergeants when necessary. Each 1SG turns in routine reports to combat trains representatives, turns in parts requisitions and the deadline status to the UMCP representative, picks up routine correspondence, and awaits the LOGPAC.

The 1SG or his representative meets the LOGPAC and then guides it to the company resupply point. The 1SG establishes the company resupply point using either the service station or tailgate issue technique. (NOTE: In light infantry units, service station resupply is called out-of-position resupply, and tailgate resupply is called in-position resupply.) The commander or XO, if delegated, will decide on the technique to be used and inform the 1SG. The 1SG will brief each LOGPAC vehicle driver on the resupply method to be used. He will also establish the company team resupply point and notify the commander when it is prepared. The commander will direct the platoons to conduct resupply based on the tactical situation. Either technique, or variations thereof, can be used for emergency resupply. The

following discussion outlines step-by-step procedures for service station and tailgate resupply, as well as for returning the LOGPAC to battalion trains.

Service Station Method (see Figure 8-1). The following procedures are used in the service station method:

- Tactical vehicles enter the resupply point using one-way traffic flow.
- Only those vehicles requiring immediate unit or higher maintenance stop in maintenance holding areas before conducting resupply.
- If not already evacuated, wounded in action (WIA), KIAs, and EPWs are removed from platoon vehicles once they stop at the refuel or rearm point.
- Vehicles rearm and refuel, rotating to each point.
- Crews rotate individually to feed, pick up mail, pick up supplies, and refill or exchange water cans.
- Once all vehicles have completed resupply, they move to the holding area, where the platoon leader or platoon sergeant conducts a precombat inspection (PCI), time permitting.
- Based on the enemy situation, vehicles pull out of their positions one vehicle at a time per platoon, by section, or by platoon. They are resupplied and rotated positions until the company has been resupplied.

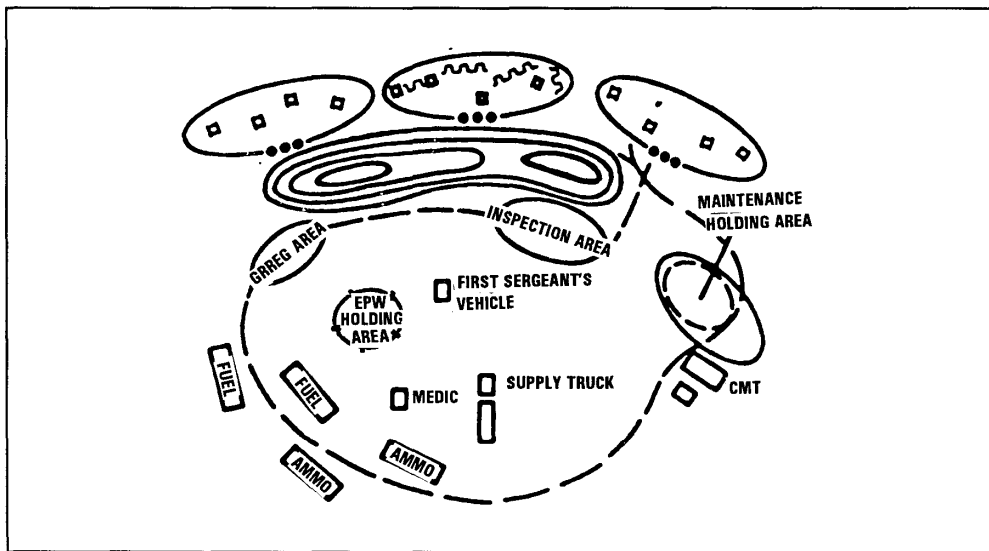

Figure 8-1. Service station issue method.

NOTE: Medical evacuation vehicles are positioned an equal distance between the refuel and rearm points. This decreases the number of stops that a vehicle has to make.

Tailgate Method (see Figure 8-2). The following procedures are used in the tailgate method:

- Combat vehicles remain in place or back out of their position a short distance so the resupply vehicle is not exposed. POL and ammunition trucks go to each vehicle position in turn.
- Crewmen rotate individually through feeding areas and pick up supplies, water, and mail.
- KIAs and personal effects are brought to the holding area by platoon personnel.
- Armored ambulances pick up critically wounded personnel; other injured are carried or walk to the ambulances for first aid.
- EPWs are centralized and guarded.
- Vehicles requiring maintenance move to the maintenance area.
- Inspections are completed by the chain of command at each vehicle position.

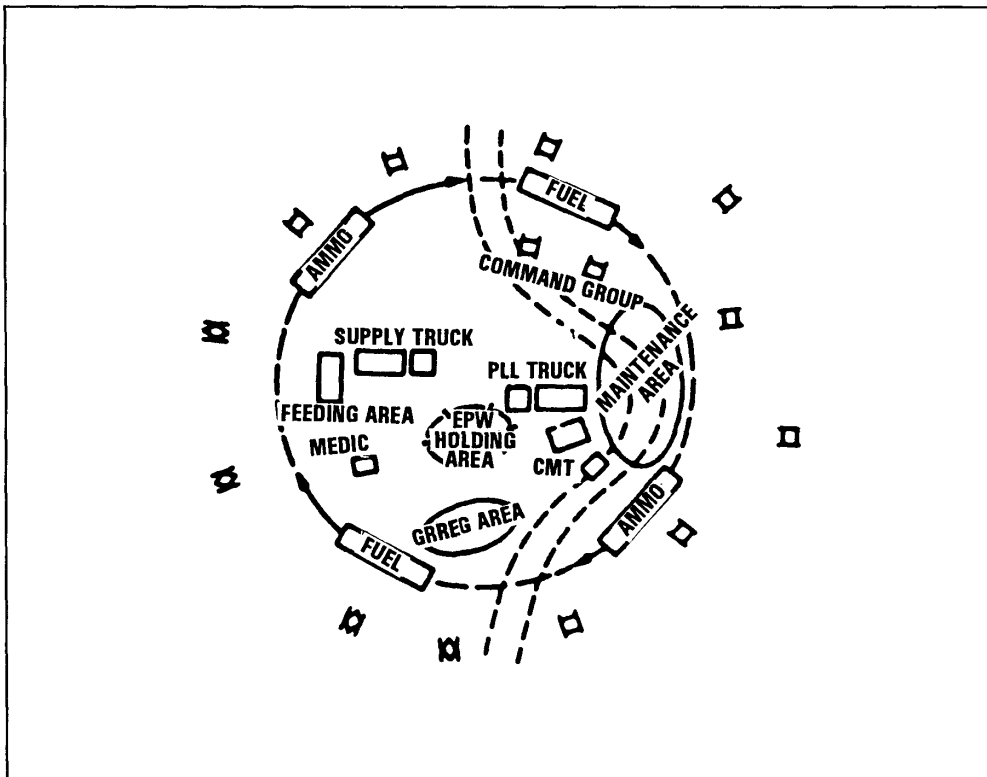

Figure 8-2. Tailgate issue method.

NOTE: The tailgate issue method is normally used only in an assembly area. If it is employed in forward positions, resupply must be masked by terrain. This procedure takes much longer than the service station method.

Preparation for LOGPAC Return to Battalion Trains. When the company team has been resupplied, LOGPAC vehicles are prepared for the return trip. Preparations include the following:

- Vehicles requiring recovery for maintenance or salvage are prepared for towing and lined up (if not previously recovered to the UMCP).
- KIAs are placed in mortuary bags or wrapped in blankets or ponchos and placed on fuel trucks, cargo trucks, and/or disabled vehicles.
- Slightly wounded personnel not already evacuated by air or ground ambulances are put on cargo trucks and/or disabled vehicles for transportation to the LRP.
- EPWs are consolidated on damaged combat vehicles or empty cargo trucks and guarded by infantrymen from a cross-attached platoon, by walking wounded, or by other company team personnel.

When resupply operations are completed, the 1SG or supply sergeant returns the LOGPAC to the LRP, where it is met by the support platoon leader. When possible, the reunited TF LOGPAC convoy returns to the field trains together. When METT-T requires, the individual company LOGPACs are dispatched individually to the field trains. Returning company LOGPACs individually is only slightly less hazardous than dispatching them forward on their own.

**Other Resupply Methods.** While LOGPACs are the preferred method of resupply, there will be times when other methods of resupply are required:

- Resupply from the combat trains (immediate resupply). The combat trains have a limited amount of supply Classes III and V for immediate unplanned resupply. The S4 coordinates immediate resupply from the combat trains and then refills or replaces the combat trains' assets.
- Cache. Caches involve positioning and concealing supplies at strategic locations around the battlefield. This is normally done during defensive operations when supplies are placed in subsequent BPs. Some key considerations are that caches need to be covered and concealed and need to have some type of security. Plans must be made for the destruction or movement of caches to prevent their capture.
- Mobile pre-positioning (MPP). MPP is similar to using caches except that the S4 retains control of the resources. With MPP, the supplies remain on the truck that is positioned forward on the battlefield. MPP is used when the S4 determines that the enemy situation or the terrain will prevent needed immediate resupply.

## PRE-POSITIONING SUPPLIES

The following discussion describes the two main methods of pre-positioning supplies:

**Method 1.** Class V supply is located in one place inside the assembly area or BP (see Figure 8-3). Each vehicle pulls into the central area to upload ammunition and rations, if any are pre-positioned. Pre-positioned fuel tankers are set up at the rear of the position, and refueling is done using the service station method.

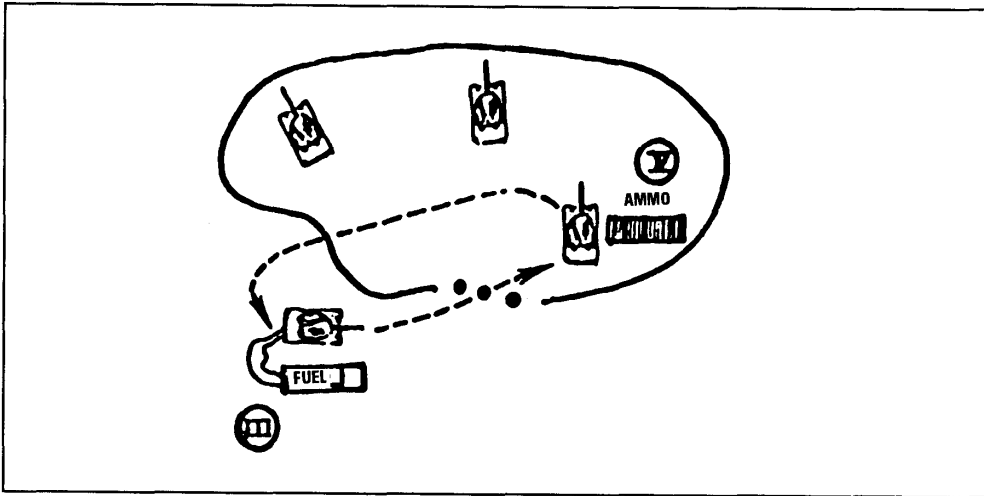

Figure 8-3. Pre-positioned supplies, method 1.

**Method 2.** Class V supply is pre-positioned (and dug-in if time permits) at each vehicle position, and Class III fuel tankers are pre-positioned in one location for the entire platoon (see Figure 8-4). In this method, Class V supplies are placed on the ground in the vicinity of each vehicle position. When the platoon arrives, three vehicles move into their fighting positions and begin to rearm. The fourth vehicle stops at the Class III fuel tanker located to the rear of the position and refuels. When that vehicle is full, it moves into its fighting position and begins to rearm while another vehicle moves to the refuel point.

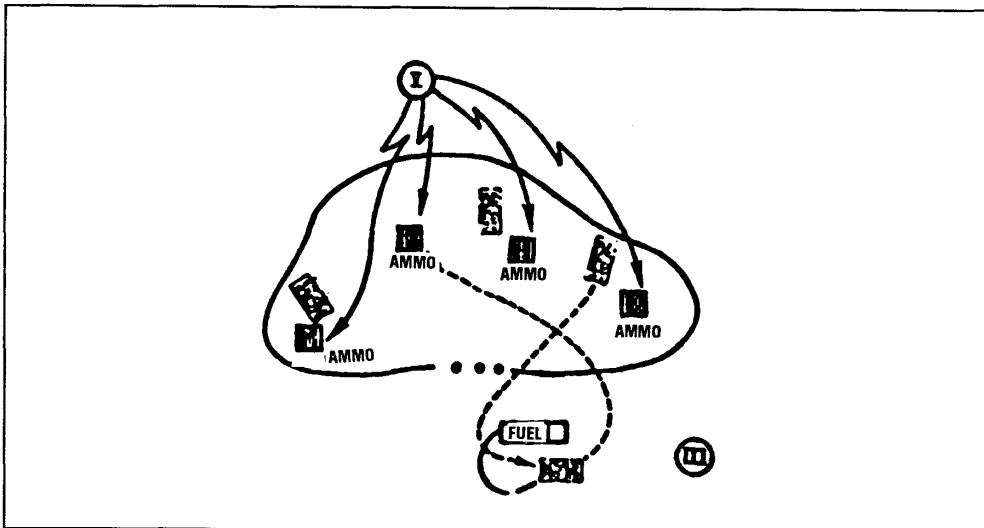

Figure 8-4. Pre-positioned supplies, method 2.



## NIGHT RESUPPLY OPERATIONS

At night, routine resupply operations are accomplished by LOGPACs; these operations are addressed in the TF SOP. Supply vehicles are led to an LRP. At the RP, the company 1SG meets his resupply package, then guides it to the company's forward position. The convoy moves in total blackout. At the RP, the company 1SG identifies his LOGPAC using prearranged signals. Possible signals include—

- Filtered flashlights, color-coded for unit identification.
- Geometric designs on vehicles identifying supported units.
- Checkpoints, marked on the ground by luminescent markers to designate the linkup point for specific companies.

## Section V. Maintenance Techniques

Maintenance is continuous. It starts with preventive maintenance by the operator and crew and continues through repairs accomplished by maintenance personnel. All personnel must be trained to accomplish the necessary tasks in all conditions. Preventive maintenance checks and services (PMCS) must be a daily crew responsibility; the DA Forms 2404 are collected during the resupply operation. Vehicle commanders submit the DA Forms 2404 to the 1SG or CMT chief prior to receiving rations. The CMT performs maintenance work as far forward as possible.

Maintenance and recovery are initiated on site by the equipment operator and crew. Once the problem has been identified, the operator and crew start corrective action, which includes—

- An initial status report to the platoon leader or platoon sergeant providing the conditions, location, and circumstances.
- An estimate of the situation to determine support requirements, including self-recovery, field fixes, assistance from nearby vehicles, or assistance from battalion.

When it has been determined that the needed repair is beyond the crew's capability, the platoon notifies the 1SG who dispatches the CMT. If additional assistance is required, the 1SG or CMT chief requests it from the BMO on the A/L net.

As a general rule, the CMT should work on a vehicle for no more than 2 hours. If the vehicle cannot be repaired within that time, it is towed to an LRP, to the MSR, or to the UMCP, as necessary.

If a vehicle cannot be recovered or is damaged beyond repair, personal items, radios, crew-served weapons, ammunition, and other serviceable items and parts are removed. The automotive and weapon systems are rendered nonfunctional to prevent enemy use. Destruction or disabling will be accomplished only on the commander's order.

The CMT normally travels at the rear of a company echelon during a road march; the exact location is an SOP item. If a vehicle becomes disabled, the crew moves it as far off the road as possible and dismounts a road guide to assist the passage of other vehicles. If the crew cannot make repairs, they wait for assistance from the CMT.

## PROCEDURES

**Battlefield Damage Assessment and Repair (BDAR).** BDAR entails inspecting battle damage to determine its extent, classifying the type of repairs required, and determining the maintenance activity best suited to accomplish the repair. Battlefield damage repair involves the immediate repair of equipment by field expedient methods, if possible. Vehicle commanders are the first line of leaders that are trained in techniques of BDAR; each subsequent echelon of maintenance conducts BDAR. BDAR manuals outline specific procedures for most combat vehicle systems.

**Categories of Maintenance.** Maintenance involves inspecting, testing, servicing, repairing, requisitioning, rebuilding, recovering, and evacuating. Repair and recovery are completed as far forward as possible, at the lowest capable echelon. When equipment cannot be repaired on site, it is moved only as far as necessary for repair. When all maintenance requirements of the TF cannot be met, the XO determines maintenance support priorities for subordinate units based on operational requirements of the TP and on recommendations of the S4 and BMO. The Army maintenance system consists of the following four levels of maintenance:

- **Unit maintenance.** Unit maintenance consists of maintenance tasks performed by the operator and crew and those performed by unit mechanics:
  - Tasks accomplished by the crew or operator include PMCS, inspecting, lubricating, cleaning, preserving, tightening, spot painting, and minor adjustments. The crews must perform maintenance within their capability and promptly report any requirements beyond their capability.
  - Unit mechanics isolate faults with built-in or automatic test equipment, conduct visual inspections, make minor adjustments, and repair end items by exchanging faulty modules and components. These functions can be performed on site or in the UMCP. Unit mechanics also perform recovery tasks.
- **Direct support (DS).** DS mechanics diagnose and isolate defective end items. DS maintenance support teams (MST) operate from the UMCP. If equipment cannot be repaired in the UMCP due to time constraints, work load, or the tactical situation, it is recovered to the BSA for repair. The maintenance company also operates a repairable exchange (RX) activity and performs light body repair.
- **General support (GS).** GS maintenance involves repair of modules and components by replacing internal pieces or parts and repair of end items involving time-consuming tasks. GS is performed by units at echelons above corps.
- **Depot.** Depot maintenance personnel rebuild end items, modules, and components. They perform cyclic overhaul and extensive modifications of equipment. Depot maintenance is performed by US Army Materiel Coremand (AMC) depots, contractors, and host-nation support personnel in freed sites.

## FORWARD SUPPORT MAINTENANCE

**Combat Power.** Combat power is maximized when disabled equipment is repaired as far forward and as quickly as possible. The BMO, in coordination with the XO, directs the maintenance effort for the TF by using established time guidelines and by coordinating maintenance actions.

**Time Guidelines.** Maintenance time guidelines are the maximum times that unserviceable equipment should remain in various support areas. Battle damage assessment (BDA) and diagnosis indicate repair time. The item is repaired on-site or recovered directly to the appropriate maintenance echelon in the appropriate support area. Factors in the decision include—

- Tactical situation.
- Echelon of work required.
- Availability of required repair parts.
- Current work load in each area.

Table 8-1 lists typical maintenance time guidelines. These times are flexible and should *not* be considered restrictive.

Table 8-1. Maintenance time guidelines.

TIME FOR REPAIR (HOURS)	LOCATION
Less than 2	On site
2 to 6 (and can be towed until repaired)	UMCP
6 to 24 (or less than 6, if vehicle cannot be towed)	Field trains
24 to 36	DSA

**Maintenance Concepts.** The following discussion of battlefield maintenance concepts places the various maintenance echelons into proper perspective. The discussion illustrates how echelons overlap to provide continuous maintenance support to the maneuver units.

The BMO task organizes the maintenance platoon based on his analysis of current and anticipated requirements. He is concerned with providing the appropriate support at each of three locations—the maneuver company, the UMCP, and the field trains. Normally, the BMO positions CMT recovery vehicles and equipment with crews to support each company. The intent is to provide a quick-fix capability for those items that can be repaired in less than 2 hours and recovery capability for those items requiring more extensive repairs. The remainder of the CMT operates from the UMCP under the control of the BMO. When the tactical situation permits, the entire CMT may go forward to provide additional support forward.

The UMCP is normally under the control of the BMO and battalion maintenance technician (BMT). It is task organized with the maintenance platoon headquarters (-), one or more PLL trucks from the administration section, remaining recovery vehicles from the recovery section, track automotive and turret repair teams from the service section, wheeled vehicle assets from the CMTs, and the DS MST. Task organization of the UMCP is modified based on the BMO's analysis of maintenance requirements and the tactical situation. The UMCP must become a collection point for nonoperational vehicles (those that cannot move on an hour's notice). Anything that cannot be repaired in the UMCP, or that cannot be towed by UMCP assets, will be recovered to the field trains or directly to the FSB maintenance company in the BSA.

The remainder of the battalion maintenance platoon is in the field trains under the control of the battalion motor sergeant. The maintenance platoon organizes to support cross-attachment as well as pure battalion operations. As previously discussed, one CMT is cross-attached to support each detached company. This team may be supplemented by an element from the maintenance services section.

In the unlikely event that the battalion detaches more than two companies, the maintenance platoon will task organize, including PLL, to support this detachment. Additionally, the administration section is organized to quickly detach one PLL truck, with trailer and a PLL clerk, to support the detached company. To support this concept, the administration section configures four PLL trucks and trailers to carry the PLL needed to support one maneuver company each. Additionally, these vehicles will transport enough packaged POL to support repair operations. One of the remaining PLL trucks and trailers will be configured to carry the PLL associated with headquarters and headquarters company (HHC) tracked vehicles. The remaining PLL truck and trailer will be configured to carry the PLL for the battalion's wheeled vehicles; it operates from the field trains.

High-demand, low-volume parts are carried on the CMT's tracked vehicles. The selection of parts carried forward on the tracked vehicles, as well as the breakout of parts to be carried on each PLL truck and trailer, should be addressed in the battalion maintenance platoon SOP.

Attached maintenance elements come under the control of the BMO. Since the attached maintenance elements are equipped and trained to support the corresponding attached maneuver unit, they are used primarily for this support. Task organizing attached maintenance assets is not routinely done for the following reasons:

- PLL repair parts cannot be readily split up to support lower than company level.
- Special tools and test sets are usually one-of-a-kind items and will not be readily available to detached mechanics.
- Personnel movements require coordination, transportation, and time. When the task organization changes, the process must be reversed.

The maintenance process is initiated on site by the equipment operator and crew. BDAR is performed, and whatever the cause of the equipment malfunction, the operator and crew begin corrective action. The vehicle commander makes an initial status report to the platoon leader describing the inoperable condition(s), circumstances, and location. When subject to direct fire, the vehicle commander uses smoke to screen the vehicle, if possible. He employs self-recovery or uses another vehicle to push or tow his vehicle to a covered position. He then isolates the fault as quickly as possible and determines what will be needed (recovery, parts, or repairs) to fix the vehicle. He does this using the procedures outlined in the BDAR manual, considering mission-essential maintenance only. The vehicle commander considers use of self-recovery, field fixes and expeditors, and assistance from other elements in the vicinity to put his vehicle back into action. He consults the BDAR criteria in the technical manual; if repairs are beyond his capability, he requests assistance as prescribed by unit SOP. If the item can be returned to operation by local resources, he initiates action to do so.

When the platoon leader determines that repair is beyond the platoon's capability, he contacts the 1SG or XO. The 1SG dispatches the CMT as soon as it is feasible and informs the BMO over the A/L net. Procedures for requesting support are in the TF SOP, to include applicable communications security (COMSEC) requirements. Information usually required includes—

- Identification of unit.
- Identification of equipment.
- Location (map coordinates).
- Nature of damage.
- Evaluation of on-site repair (extent of damage, level of repair, and estimated time required).

- Repair parts required, if applicable.
- Enemy situation, security, and NBC considerations.
- Recommended route of approach.
- Contact points for unit guides, if required.

The CMT HMMWV and recovery vehicle are forward in the company trains. These vehicles carry the tool boxes, unit-level technical manuals, and a limited number of special tools and repair parts. (M1 and M2 test equipment normally remains at the UMCP because of its size; it may be sent forward as needed based on the BMO's and CMT's assessments.) The CMT confirms the vehicle commander's BDA before attempting repairs. The CMT usually repairs damage on site if the repair can be completed within two hours.

If a damaged vehicle cannot be repaired within two hours, it is recovered to the UMCP or the field trains to make maximum use of the weapon systems for defense of the site. However, before a recovery vehicle is committed, other recovery means are attempted. Field expedient procedures may return enough mobility to let the damaged equipment move. Other damaged (but mobile) equipment may tow the damaged vehicle. The tactical situation may permit an operable like vehicle to do the recovery when a recovery vehicle is not available. The option of having the CMT recover the vehicle only as far as a maintenance collection point (MCP), or the MSR, and then returning to the company to continue support should also be considered. Maintenance platoon recovery vehicles can then recover the vehicle from the predetermined drop site to the UMCP.

Damaged vehicles recovered to the UMCP are repaired by maintenance platoon elements or MSTs from the FSB maintenance company. When not involved in on-site repairs, the CMTs may also repair vehicles in the UMCP. This is especially true of work requiring diagnostic test equipment that cannot be taken into combat positions.

Vehicles that cannot be repaired within 6 hours or that would otherwise overload the capability of the UMCP are recovered to the field trains or directly to the FSB maintenance company collection point for repair. This recovery may be accomplished by the CMT recovery vehicle alone; by the CMT recovery vehicle to an MCP or MSR, then by a maintenance platoon recovery vehicle; or by a combination of recovery vehicles and heavy equipment transporters (HET). The BMO will coordinate and direct the exact method to be used. The use of HETs is preferred, but they are restricted by road requirements and availability. HETs are requested through the FSB maintenance company. Some crew members accompany the vehicle to the rear to assist mechanics in the repair of the vehicle and return it to the unit when repaired. They also man operational weapon systems on the vehicle to provide additional security for rear areas. Communications-electronics (CE) equipment installed in the vehicle is evacuated with the vehicle. Personal equipment of crewmen not accompanying the vehicle and any special equipment are removed before the vehicle leaves the area.

The UMCP displaces with the other elements of the combat trains. During periods of frequent displacement, the BMO may direct that the UMCP displace by echelon. In this case, some assets of the maintenance platoon, including the BMO, complete repair on vehicles at the old UMCP, then displace forward to the new location. Maintenance platoon assets not involved with these repairs move with the remainder of the combat trains and establish the forward UMCP.

During rapid forward moves such as an exploitation, the UMCP conducts mission-essential maintenance only (MEMO) repairs and simple recovery. Other disabled vehicles are taken to MCPs on an MSR and remain to be repaired or evacuated. Field trains and the maintenance company of the FSB displace forward to subsequent locations. The BMO coordinates repair or evacuation with the battalion motor sergeant in the field trains.

In field trains, remaining elements of the battalion maintenance platoon perform other tracked and wheeled vehicle maintenance and Class IX resupply. The BMO coordinates

requirements with the HHC commander and with the maintenance company of the FSB. He also coordinates maintenance requirements with the parent headquarters of any attached or supporting elements working with the TF.

**Maintenance Operations at Night.** At night, as during the day, vehicles are processed and integrated into the work program as soon as they are damaged. They are positioned in lightproof or light-suppressing shelters. Permanent structures such as warehouses, civilian garages, and barns are used. Work continues until the repairs are completed.

If large shelters are not available, mechanics repair small components, on or off the vehicle, under a lean-to or some other makeshift shelter constructed of a tarpaulin or a poncho. Chemical light sticks provide adequate light for most detailed repairs under these conditions.

Most maintenance work is accomplished in fighting positions or in the UMCP. To prevent congestion and confusion, a staging area is designated for vehicles awaiting repair. Tow cables or tow bars remain attached to vehicles that cannot move under their own power. This makes it easier to move the vehicle quickly when necessary.

Forward of the UMCP, mechanics use night-vision goggles (NVG) to accomplish most repairs, marking tools and other small components with luminescent tape. Using night-vision devices (NVD) for repair of equipment is a very time-consuming and dangerous process, requiring extreme care. When NVG are not available, repairs are made under lightproof shelters. Heavy vegetation or thick overhead foliage provides additional concealment.

## Section VI. Field Services

### MORTUARY AFFAIRS

Normally, divisions do not possess organic mortuary affairs assets. It is the responsibility of the mortuary affairs NCOs within the support battalion to train personnel on mortuary affairs operations. Personnel under the control of the mortuary affairs NCO are responsible for mortuary affairs support for the division until mortuary affairs augmentation is available.

**Commander's Responsibilities.** All commanders are responsible for the search, recovery, initial identification, and evacuation of deceased personnel from their area of responsibility. These remains include, but are not limited to, members from their own unit, other services, allied, enemy, and other remains that may be found in the area. Commanders must ensure that recovery and evacuation of remains are conducted in a respectful manner. Evacuation by air or ground to the nearest collection point, or to the theater evacuation point must be accomplished promptly.

**Search and Recovery.** When unit personnel recover remains they must preserve all items that may be used to establish an identity. They must check to see if there are identification tags or personal effects on the remains and ensure these items stay with the remains. When identification tags are found anywhere but around the neck of the remains, they are placed in a personal effects bag. If DD Form 1380 (Field Medical Card) is found, soldiers must ensure it is attached securely to the remains and protected from body fluids. All personal effects and equipment are put with the remains and the immediate area searched to ensure all effects and portions of remains have been recovered. The remains are shrouded with any suitable material, such as a human remains pouch, poncho, or poncho liner. The remains are then evacuated to the nearest collection point or directly to the theater evacuation point. Emergency burials should only be conducted when the tactical situation does not allow evacuation.

## CLOTHING EXCHANGE AND BATH

Clothing exchange and bath (CEB) services are provided by the supply and service (S&S) company, when augmented. CEB services are requested through the brigade S4. The request must specify location of the unit making the request, desired time for service, and range of clothing sizes for unit members. The requesting unit must be prepared to provide soldiers to help set up the CEB point. During CONOPS, CEB services may not be available. Planning for alternate means, such as "Australian shower buckets," is recommended.

## SALVAGE SERVICES

Salvage services are provided by the FSB supply company. A salvage collection point is established in the BSA. It receives serviceable, unserviceable (repairable), discarded, abandoned, and captured supplies and equipment. The salvage point will not accept COMSEC and medical supplies, toxic agents, radioactive materials, contaminated equipment, aircraft, ammunition, and explosives.

# Section VII. Personnel Support

## PERSONNEL SERVICES

Personnel service support includes CSS functions that sustain the morale and welfare of the soldier. These include personnel and administration (P&A) services, religious support, legal services, finance services, public affairs, postal services, EPW support, and medical support. P&A services fall within the staff area of the battalion S1.

**Strength Accounting.** Company teams and attached units submit a personnel daily summary report to the S1 in the combat trains CP. The S1 forwards a TF consolidated report through brigade to the division adjutant general (AG). The PAC in the field trains is furnished an information copy. These reports, together with authorized position vacancies, are the basis for requesting individual replacements and Class I resupply. Accurate strength reports also provide the commander and staff with information to plan future operations. Daily reports are included in the TF SOP.

**Casualty Reporting.** The S1 ensures that both strength and casualty reporting occur in a timely and accurate manner. Casualty reports provide the detailed information necessary to cross-check strength reports. Casualty reporting occurs as soon as possible after the event and is initiated by the squad leader, TC, or any individual having knowledge of the incident. The casualty feeder report (DA Form 1156) is carried by all small-unit leaders to report battle and hostile-action casualties and nonbattle casualties. It provides initial information to the AG for preparing the casualty report used by DA to notify next of kin. The casualty feeder report also validates the soldier's line-of-duty status, which determines payment of benefits. When a soldier is reported missing or missing in action (MIA) or when the remains are not under US control, a witness statement (DA Form 1155) accompanies the casualty feeder report. Casualties are reported to the ISG, who collects and forwards them to the combat trains CP. The S1 cross-checks the reports, requests any needed clarification, adjusts unit strength reports, and forwards the reports through the brigade S1 to the AG.

**Replacement Operations.** Replacement flow is monitored by the PAC in the field trains. The HHC commander establishes a replacement receiving point in the field trains and notifies the brigade S1 of its location. All replacements or returnees are brought to this point for initial processing. The division AG is normally responsible for delivering replacements to the BSA. Hospital returnees are handled as replacements by the division AG. Every reasonable effort is made to return the recovered soldier to his original unit. Returnees from the

BSA treatment station are released directly to their field trains. They move forward to their unit with the LOGPAC.

**Other Administrative Services.** Intense combat greatly reduces time available for processing of personnel actions. Consequently, actions not seriously affecting troop morale will receive low priority. During lulls in the battle, the S1 and PSNCO complete all other necessary P&A actions. If possible, these are accomplished by forming personnel contact teams that move forward to company locations.

## **RELIGIOUS SUPPORT**

Religious support is provided by the unit ministry team (one chaplain and one chaplain assistant) operating from the combat trains. The unit ministry team is dedicated to meeting the religious, moral, ethical, and spiritual needs of soldiers in combat. Additionally, chaplains advise the commander on the state of the soldiers' religious support needs. He also provides information on local religious groups and their possible effect on mission accomplishment.

## **LEGAL SERVICE SUPPORT**

Legal service support is provided to the TF on a GS basis. It includes legal advice to commanders on military, domestic, foreign, and international law and advice and representation for soldiers in military justice and administrative actions.

## **FINANCE SERVICE SUPPORT**

Finance units provide DS/GS on an area basis. Individual support includes casual payments, check cashing, currency conversion, and pay inquiries. Organizational support covers contracting support and commercial vendor operations, and reimbursement of imprest fund cashiers and Class A agents. Before deployment, units will have officers with appointments prepared and trained for Class A agent duties. FM 14-7 provides detailed information.

## **POSTAL SERVICE SUPPORT**

Postal service support is provided by the postal element assigned to the corps DS postal company, which receives mail and separates it by battalion, then turns it over to the brigade S1. The battalion mail clerk receives and sorts the mail and distributes it to the unit supply sergeant (assistant mail clerk), who delivers it to the 1SG or to the soldier himself during LOGPAC resupply. When a soldier mails a letter, the procedures are reversed.

Normally, mail is delivered and received with the LOGPAC. The brigade and TF S1s must establish procedures to ensure mail is sorted and delivered based on current task organizations. Procedures must also be established to properly secure accountable mail until it is delivered to the addressee. Packages are not routinely sent forward during combat operations; procedures for handling packaged mail are normally established by division or higher.

## **ENEMY PRISONERS OF WAR**

The S1 plans and coordinates EPW operations, collection points, and evacuation procedures. EPWs are evacuated from the TF area as rapidly as possible. The capturing company is responsible for guarding prisoners, recovering weapons and equipment, removing documents with intelligence value, and reporting to the main and combat trains CP. EPWs are evacuated to the brigade EPW collection point on returning LOGPAC vehicles or are moved to the MSR under guard and their location reported to the S4, who



coordinates transportation. As necessary, the S2 reviews and reports any documents or information of immediate value. The S4 coordinates evacuation of large amounts of enemy equipment. Wounded prisoners are treated through normal medical channels but are separated from US and allied patients. The unit chaplain may conduct services for EPWs or assist detained chaplains of enemy forces.

At company level, EPWs are transported to the battalion TF EPW collection point as quickly as possible. The ISG is responsible for their security and transportation. Guards remain with EPWs until released by the battalion S1. The exact procedure for evacuation will be according to battalion SOP.

## Section VIII. Health Service Support

TF health service support is planned by the medical platoon leader and S1 and is provided by the battalion medical platoon. Backup support is provided by the FSB medical company. To support TF operations, the medical platoon leader must understand the scheme of maneuver as well as the support plan of the FSB medical company.

### ORGANIZATION

The medical platoon is organized with a platoon headquarters, a treatment squad, four ambulance squads, and a combat medical section. This organization is designed to facilitate quick evacuation of wounded soldiers so that they can be treated by trained medical personnel within 30 minutes of the time they are wounded. The medical elements are organized as follows:

- The platoon headquarters contains the medical platoon leader and the platoon sergeant. They operate the CP and provide C3 for the medical platoon.
- The treatment squad contains the platoon leader (battalion surgeon), the physician's assistant (PA), and the treatment personnel. They can form one or two BASS capable of operating from, or forward of, the battalion combat trains using their organic M577s.
- The ambulance squads operate from the company trains and from the BAS. Tracked ambulances and crews habitually work with the same company, as do medics from the combat medical section. The senior combat medic acts as the squad leader for this ad hoc company medical team.

### OPERATIONS

**Maneuver Company.** Maneuver company medical support includes—

- Providing emergency triage and emergency medical treatment to sick and wounded personnel. Until patients are evacuated or returned to duty, protection is provided to prevent further injuries from artillery fragments and small arms by placing them inside armored ambulances or other protected enclosures.
- Assisting combat vehicle crews in evacuating injured crewmen from their vehicles.
- Providing medical evacuation for nonambulatory patients and assisting the evacuation of ambulatory patients, and providing evacuation means if the tactical situation permits.
- Initiating the field medical card for the sick and wounded and, time permitting, completing this card on deceased personnel.

- Screening, evaluating, and treating patients suffering from minor illnesses and injuries. Patients requiring no further attention are returned to duty; those requiring additional treatment are evacuated to the BAS.
- Remaining abreast of the tactical situation and complying with the instructions of the unit 1SG.
- Ensuring that the company commander and the battalion surgeon are informed of the status of patients seen and of the overall health status of the company.
- Training unit personnel to enable them to perform self-aid/buddy aid.
- Coordinating for anticipated logistics support for deployed team.
- Providing trained combat lifesavers.
- Ensuring that medical waste is properly handled and disposed.

**Battalion Aid Station (BAS).** The BAS provides the facility and the medically trained personnel to stabilize patients for further evacuation, to perform immediate lifesaving or limb-saving surgery, and to treat patients with minor wounds or illnesses and return them to duty. Additionally, the BAS can operate two treatment teams if the tactical situation requires it. Other functions of the BAS include—

- Receiving and recording patients.
- Notifying the S1 of all patients processed, giving identification and disposition of patients as directed by SOP.
- Preparing field medical cards, and verifying information on them.
- Requesting and monitoring aeromedical evacuation of patients.
- Monitoring personnel, when necessary, for radiological contamination prior to medical treatment.
- Decontaminating and treating chemical casualties.
- Monitoring the activities of medical platoon personnel attached to company teams.
- Disinfecting nonpotable water for consumption at battalion water resupply points.
- Treating patients with combat stress. These patients are comforted, given food and drink, observed for a short time, put to work assisting medical personnel, and later returned to duty.

**Medical Evacuation.** Medical evacuation is the process of moving patients from the point of injury or illness, through successive medical treatment facilities, to the appropriate facility for treatment, early return to duty, or evacuation out of the combat zone. Medical evacuation is the responsibility of the next higher level medical support; for example, the FSB medical company evacuates patients from the BAS or coordinates medical evacuation from corps resources. Patients are evacuated no farther to the rear than their condition requires. These considerations also apply:

- Medical evacuation within the TF is routinely accomplished by the medical ambulance squads. Medical evacuation outside the TF may be accomplished by ground evacuation or by a combination of ground and air ambulances.
- Aeromedical evacuation out of the TF sector is used as much as possible. Ground ambulances are used only for patients who cannot be evacuated by air. The specific mode of evacuation is determined by the patient's condition, aircraft availability, and tactical situation. The physician or PA treating the patient normally makes this determination.

**Medical Supply and Property Exchange.** The medical platoon maintains a two-day stock of medical supplies. To prevent unnecessary depletion of blankets, litters, splints, and the like, the receiving medical facility exchanges like property with the transferring agency. Medical property accompanying patients of allied nations is disposed of in accordance with STANAG 2128.

**Preventive Measures.** Combat casualties may not constitute the majority of hospital admissions. Experience in World War II, Korea, and Vietnam indicates that the vast majority were for disease and nonbattle injuries not directly attributable to enemy action. Commanders can reduce disease and nonbattle injury by emphasizing the following preventive measures:

- Unit and mess sanitation and personal hygiene.
- Battlefield safety.
- Combat dress identification.
- Water purification and control.
- Immunization programs.
- Venereal disease prevention.
- Heat and cold injury prevention.
- Proper work-rest cycles.
- Pest control.

**Company Health Service Functions.** The medical aid team attached to the company provides emergency medical aid and evacuation for the company. The team provides first aid for minor injuries and illnesses and emergency medical treatment to stabilize seriously wounded soldiers for transportation to the BAS. Medics advise the commander and assist company field sanitation teams in maintaining the health of the soldiers. The medics are under the control of the 1SG. They must know where the BAS is located and how to find their way there and back without assistance.

Casualties are sustained by combat lifesavers and platoon medics until they can be moved to a covered position for transfer to the company medics. The 1SG dispatches the armored ambulance to meet the vehicles with wounded aboard. If there are several casualties in each platoon, the platoons consolidate their wounded in one spot for treatment and evacuation. Based on reported severity of wounds, the 1SG requests air evacuation (for the most critically wounded) or assistance from the BAS. The company aidmen triage the wounded, stabilize them for transportation, and treat them for shock. If neither air evacuation nor assistance from the BAS is available, the most serious casualties are transported to the aid station by the company's armored ambulance. The commander must approve this because it will deprive the company team of most of its medical support. For the less seriously wounded, the 1SG arranges for evacuation to the BAS using any available vehicles.

Weapons and military equipment needed immediately by the company team will not be evacuated with the wounded. The wounded will keep their protective masks and any personal items.

## APPENDIX A

# AIRLIFT OPERATIONS

Airlift operations provide the means by which contingency forces rapidly enter a hostile or nonhostile AO under any conditions of the operational continuum. The initial airlift priority will probably go to an opposed-entry-capable division (airborne); it will then shift to other light forces that will expand operations. If opposed entry is not required, initial airlift priority may go to any specified light contingency division.

This appendix discusses all the elements of airlift planning, including opposed-entry planning considerations. Because resupply may be by air to support any given operation, airlift planners in contingency divisions must be familiar with some opposed-entry procedures, such as LVAD and low altitude parachute extraction system (LAPES).

## PLANNING

Four plans are developed for the execution of airlift operations—the ground tactical plan, the landing plan, the air movement plan, and the marshaling plan. These plans are developed primarily by Army planners in coordination with the USAF. A reverse planning sequence is used beginning with the ground tactical plan.

Opposed-entry operations are based on a detailed ground tactical plan. The landing plan, air movement plan, and marshaling plan are based on requirements to support the success of the ground tactical plan. Airland forces require a secure airfield; therefore, they do not require a ground tactical plan and landing plan that are as detailed as those for an opposed-entry capable force. Air movement and marshaling plans are required by any contingency force.

**Ground Tactical Plan.** The ground tactical plan is developed from analysis of the mission, enemy, terrain, weather, forces available, and the start time and duration of the operation. The ground tactical plan, as a minimum, contains—

- An airhead line.
- Assault objectives.
- Combat outposts.
- Reconnaissance and security forces.
- Boundaries.
- Assault task organizations.
- Reserves.

Once terrain has been analyzed for offensive operations, it must be considered for defensive operations. Terrain that must be retained or controlled is identified. Enemy avenues of approach into the operational area are analyzed. BPs that offer good cover and concealment and long-range fields of fires are planned along avenues of approach. Natural obstacles that can be extended or improved are also important.

Weather in the objective area must be checked. With the exception of high winds or thunderstorms in the objective area and less than minimum acceptable weather conditions at departure airfields, weather has only a limited effect on delivery of an airborne force. Precipitation does not affect parachute operations. Wet soil conditions, however, can prevent airlanding operations on unimproved runways. Limited visibility caused by rain or fog can hamper delivery of supplies and equipment by the LAPES and can limit CAS.

The degree of visibility in the objective area during an airborne assault influences the conduct of the operation. Deployment at night enhances mission accomplishment. Periods of reduced visibility conceal the airborne assault, add the element of surprise, and exploit night vision capabilities.

Sufficient airlift capability must be available to deliver the division to the objective area. When there are too few aircraft to deliver the assault echelon in a single lift or in multiple lifts over a short time, risk to the force could be unacceptable. Airlift must be available not only to deliver the force, but also to sustain it until completion of operations. The ground tactical plan serves as the basis for the other three plans in this area.

**Landing Plan.** The landing plan contains the sequence and method of delivery into selected DZ and LZ in the AO. The landing plan is the link between the air movement plan and the ground tactical plan. It contains the following information:

- Locations of DZs, LZs, and LAPES extraction zones.
- Sequence in which the zones will be used.
- Method of delivery.
- Parachute hour (P-Hour).

**Air Movement Plan.** The air movement plan is prepared jointly as an annex to the OPORD. It covers all actions from the time units load aircraft until they arrive at the AO (P-Hour). It supports the landing plan and contains the flight route diagram to the DZs and the air movement table. The flight route diagram contains—

- The flight route.
- The location and directional orientation of the DZs and landing strips.

The air movement table contains—

- Departure airfield(s) for each serial.
- The number and type of aircraft in each serial.
- The aircraft parking diagram.
- Names of USAF unit commanders.
- Aircraft designated for personnel, heavy drop, or LAPES.
- Station and takeoff times.
- P-Hour for lead aircraft in each serial (if airdrop).

**Marshaling Plan.** The marshaling plan provides for the assembly of personnel, equipment, and supplies to be employed in the execution of the airborne operation. It includes everything from the issuance of the WO to the loading of aircraft. The timeline to be executed during the marshaling phase and the necessary actions deploying units must exercise (ammunition issue, contingency stocks of combat items) are usually outlined in the unit readiness SOP. Specifically, the marshaling plan covers—

- Rigging of equipment and personnel for airborne assault.
- Marshaling, preparing, and inspecting vehicles and equipment for air movement/airland.
- Movement plan to personnel holding areas.
- Administration and legal requirements.
- Execution of troop-leading procedures.
- Staff-to-commander backbriefs.
- Concurrent planning.

## ORGANIZATION

The division is organized into two echelons for an airborne operation—assault and follow-on.

The assault echelon consists of units required in the initial stages of the operation to seize assault objectives, including battalion, brigade, and division TAC CP and assault CPs. The assault CPs are tailored based on mission requirements identified in the predeployment or crisis action phase. The assault CP performs the same function as a TAC CP; however, it is almost completely dismounted. Vehicles and personnel in the follow-on echelon augment the assault CPs to form TAC CPs.

The follow-on echelon includes selected outsized loads and additional support assets. This echelon contains those units or elements that give the division the ability to conduct sustained combat within organizational limitations.

The airborne division organizes for combat in the same way as other divisions, with one major difference: units normally OPCON or DS to a brigade (for example, armor, artillery, engineer, and air defense) are attached for the deployment and initial combat phase of the operation. Attachment provides for C2 until parent units are established within the division airhead. Brigade attachments normally include, one light armor company, one light field artillery battalion, an ADA battery, an engineer company, an MP platoon, a forward area signal center platoon, the FSB, and USAF TACP. These units normally revert to DS and continue to support the brigade after control is centralized at division.

The sequence of unit arrival in the airhead is determined by the mission assigned. Brigade elements land on or near assault objectives. This is done to ensure early securing of assault objectives by surprise. Air Force combat control teams (CCT) and the elements of the airborne division's long-range R&S detachment deploy simultaneously to the AO. They are inserted prior to the airborne assault to collect human intelligence (HUMINT) and to conduct pathfinder operations to support the airborne assault. USAF FAC accompany the lead brigades.

Personnel and equipment are cross loaded on aircraft within a serial. Crossloading permits personnel and equipment to exit the aircraft in a sequence that facilitates assembly. Recovery of heavy-drop items is expedited through the use of crossloading and distinctive equipment markings according to local SOP. Heavy equipment and supplies may be brought into the airhead by any combination of three different delivery means:

- Airland.
- LVAD.
- LAPES.

During airland operations, aircraft land on available runways in a secure area to deliver cargo. They land, quickly dispense their cargo, and take off immediately. The airland method ensures negligible damage to materiel; delivers vehicles ready for immediate drive-away; delivers crews with their weapons and vehicles; and provides for the backhaul of casualties, EPW, and damaged equipment. Airland operations have the disadvantages of requiring LZs and more time for delivering loads than the other two methods. Additionally, aircraft and units are extremely vulnerable to enemy direct and indirect fires during landing and unloading.

All combat equipment and supplies of the airborne division can be delivered by LVAD and LAPES with or without airland facilities available.

During a LAPES operation (C-130 only), aircraft approach an identified cargo delivery strip flying several feet above the ground. An extraction parachute is deployed by the flight crew; the cargo is pulled out of the aircraft, hits the ground, and slides to a halt. The

aircraft then regains altitude and leaves the area. A secure LZ and USAF control teams are usually required at the site. Wet soil conditions hinder LAPES operations. LAPES requires less preparation time, personnel, and equipment support than LVAD. LAPES is a pinpoint delivery system for large items of equipment; however, materiel is more susceptible to damage when the LAPES method is used as compared to the airland method. Additionally, the LAPES zone may require a significant amount of preparation.

LVAD operations (C-130, C-141, C-17) are used during the initial assault and during follow-on delivery of cargo. During LVAD operations, the delivering aircraft eject cargo with the aid of an extraction parachute from the minimum height necessary to fully deploy cargo parachutes needed to suspend the specific cargo they are carrying (usually 500 to 1,500 feet above ground level [AGL]). Cargo used in the assault (such as light armor and artillery) is dropped minutes before assault troops parachute into the area. Assault troops then link up with the delivered cargo on the ground. In some cases, based on the commander's guidance, crews assigned to combat vehicles or systems may exit the same aircraft and follow their assigned airdropped cargo to the ground to ensure linkup and reduce derigging time (C-130 only). LVAD delivers the most cargo in the least amount of time and is usually the prime method of delivery during initial assaults.

The adverse weather aerial delivery system (AWADS) on the C-130 and station keeping equipment (SISE) on the C-141 provide all-weather delivery capability for both troops and equipment.

The CDS delivers smaller bundles of supplies via airdrop. This system provides the assault force a high assurance of accurate parachute delivery of follow-on material.

Helicopters are deployed by flying them to the airhead and/or by USAF airland aircraft. While flying them to the airhead is preferred, this may not be possible because of refueling requirements en route.

## OPERATIONS

The airborne division will be committed to combat by airborne assault, airland operations, or a combination of the two methods.

**Airborne Assault.** Normally, airborne operations are initiated by airborne assault. LZs are not required, and security of DZs is not as critical. When used, airland aircraft follow aircraft delivering parachute units. A time interval between serials permits parachute units to clear the landing area of enemy forces and to remove parachutes, equipment, heavy-drop loads, and obstacles from available landing strips.

The deployment and initial combat phase begin with the landing of the division in the airhead and terminates when assault objectives are seized. For this phase, the division commander assigns objectives and zones to the brigades, sets priority of fires, and provides the necessary forces to each brigade according to its mission. He also designates the size of the reserve and determines where it is to be located. During the assault, brigade units land in their assigned zones. Units composing the division reserve and other units not attached to brigades land in prescribed DZs and LZs. Command groups move with different serials to prevent loss of an entire command group due to enemy action or aborted aircraft mission.

Brigades assign assault objectives and zones to battalions. DZs and LZs are located on or close to assault objectives to exploit the advantage of surprise. Ground organization of forces is accomplished in assembly areas near DZs.

When assembly areas are not located on assault objectives, the brigade attacks to seize assault objectives in the same manner as the infantry brigade. After assault objectives have been seized, FA units displace within the brigade sectors to support security forces. When security forces withdraw, the artillery displaces to preselected positions.

Air defense batteries enter the airhead early to provide air defense for DZs, LZs, rearming and refueling points, and other critical division installations. Insertion of air defense units may be by LVAD, airlanding, or LAPES. Stinger missiles can be attached to and jumped in with air defense personnel in the assault echelon to provide immediate air defense coverage in the airhead. Batteries initially operate independently under brigade control until the ADA battalion is able to assume operations.

When the engineer battalion headquarters becomes operational in the AO, its companies revert to battalion control and operate in DS of the brigades. Due to the engineer battalion's limited construction assets, engineers will need to be augmented if they are tasked to construct landing facilities or to rehabilitate existing airfields.

Brigade security forces are positioned after assault objectives are seized or simultaneously with the seizure of the airhead in the case of an airborne assault. Although the brigade is responsible for the security force, the division may specify its general location. The division may also designate specific roadblocks or OPs for brigades to man.

The division reserve enters the AO as part of the assault echelon. It is organized—

- To seize an assault objective previously assigned to another unit.
- To reinforce a brigade.
- To block or counterattack an enemy force that has penetrated the security force and is threatening the success of the operation.

**Airland Operations.** Units can be airlanded on airfields near the LC or in the enemy's rear. Airland operations may be undertaken—

- When local air superiority exists.
- When enemy ADA weapons are suppressed.
- When LZs are secure.
- When unit integrity is important.

Airland forces are introduced into the objective areas as early as possible, consistent with security and availability of LZs. Units are landed on or close to the area in which they are to be employed. Since all elements cannot be transported to the AO in the same aircraft, some reorganization of forces is required prior to initiation of operations. Units must be careful not to present a lucrative target during reorganization. Selection of covered and concealed assembly areas minimizes unit vulnerability. Once assembled, airlanded forces operate like infantry forces as previously described.

## LOAD SHORING

Shoring is lumber, planking, plywood, or any other similar material. It serves many purposes. It protects the aircraft cargo floor or 463L pallet surfaces, decreases the approach angle of aircraft ramps, protects airport tarmacs, spreads weight over a larger area, and keeps 463L pallets off the ground.

Shoring is used during airland operations; it is not required for LVAD or LAPES operations. Modern cargo aircraft can carry considerable weight; however, shoring is necessary, particularly for tracked vehicles, to protect the aluminum cargo floors of the aircraft. The organization offering cargo for air shipment must provide shoring.

Not all military airlift command (MAC) aircraft have the same floor pressure tolerances. Consult the applicable aircraft loading technical order for specific limitations. Items that require shoring on one aircraft may not require shoring on another. USAF aircraft loadmasters will ensure the proper amount of shoring is used.



Light armor units must determine shoring requirements and maintain sufficient stockage on hand. Units must include the following in their logistical planning process:

- Specific amounts of shoring needed for the operation based on number of deploying vehicles and type of aircraft.
- Disposition/storage of the shoring once the aircraft lands at the AO.
- Shoring needed for redeployment and plans to acquire it.

**Size and Condition of Shoring.** Every planned aircraft load will probably need shoring. The load configuration and weight determine the thickness and width of the shoring to be used. Lengths of shoring can be cut to meet specific needs. For ease of handling, however, the length of shoring should not exceed 12 feet. Plywood also makes good shoring. Four-by-eight foot sheets are ideal for loading tracked vehicles.

All dimensions (thickness, length, and width) must be actual size. Commercial-size lumber may not satisfy this requirement. Inspect shoring before use to ensure that it is clean, sound, free of roils, and fit for its intended use. The aircraft loadmaster may reject dirty or badly warped lumber, delaying the loading of the aircraft.

**Transporting the Shoring.** When shoring is required to load cargo, it will also be needed to unload. If shoring is not available at the destination, it must be transported with the load. Include the weight of the shoring with the weight of the cargo to accurately determine the center of gravity of the load. For tracked vehicles, simply place the shoring on top of the vehicle when it is weighed.

**Types of Shoring.** There are five types of shoring—rolling, parking, bridge, sleeper, and approach.

**Rolling Shoring.** Use rolling shoring to protect airport parking ramps and the cargo floor and loading ramps of cargo aircraft from damage (see Figure A-1). This type of shoring is used to protect surfaces from damage when moving a vehicle across them. Most wheeled vehicles do not require rolling shoring, but tracked vehicles do. The minimum thickness will be 3/4 inch; however, some aircraft may require thicker amounts of shoring than others. Refer to applicable USAF technical orders.

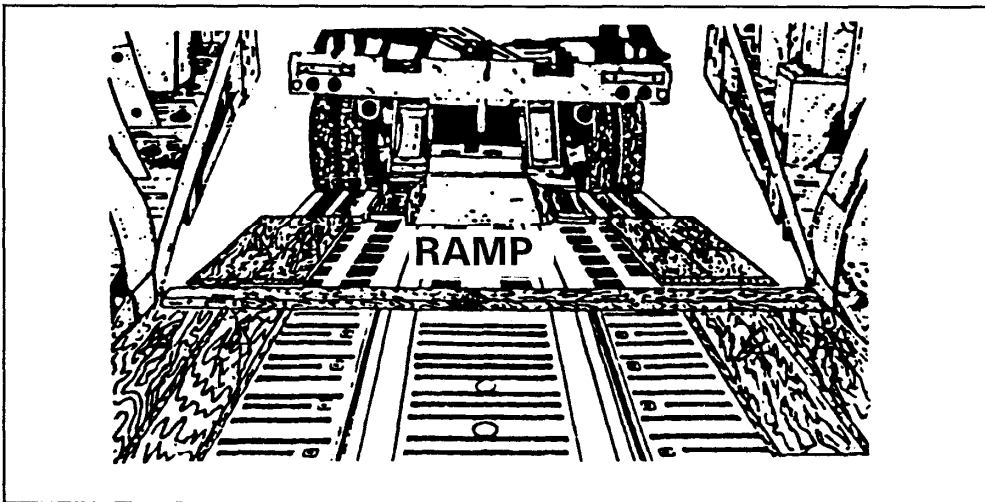

Figure A-1. Example of rolling shoring.

**Parking Shoring.** Use parking shoring to protect the aircraft floor from damage during flight (see Figure A-2). Any vehicle requiring rolling shoring also requires parking shoring. Each aircraft has specific floor weight limitation that apply to wheeled and nonwheeled cargo. Some general factors regarding parking shoring should be considered when planning an airlift movement:

- The minimum thickness of parking shoring is 3/4 inch.
- Use parking shoring to protect the aircraft floor or aircraft loading ramps from concentrated contact, such as steel wheels and trailer tongue supports and wheels.
- Most pneumatic tires do not require parking shoring.
- Always use parking shoring when rolling shoring is required.

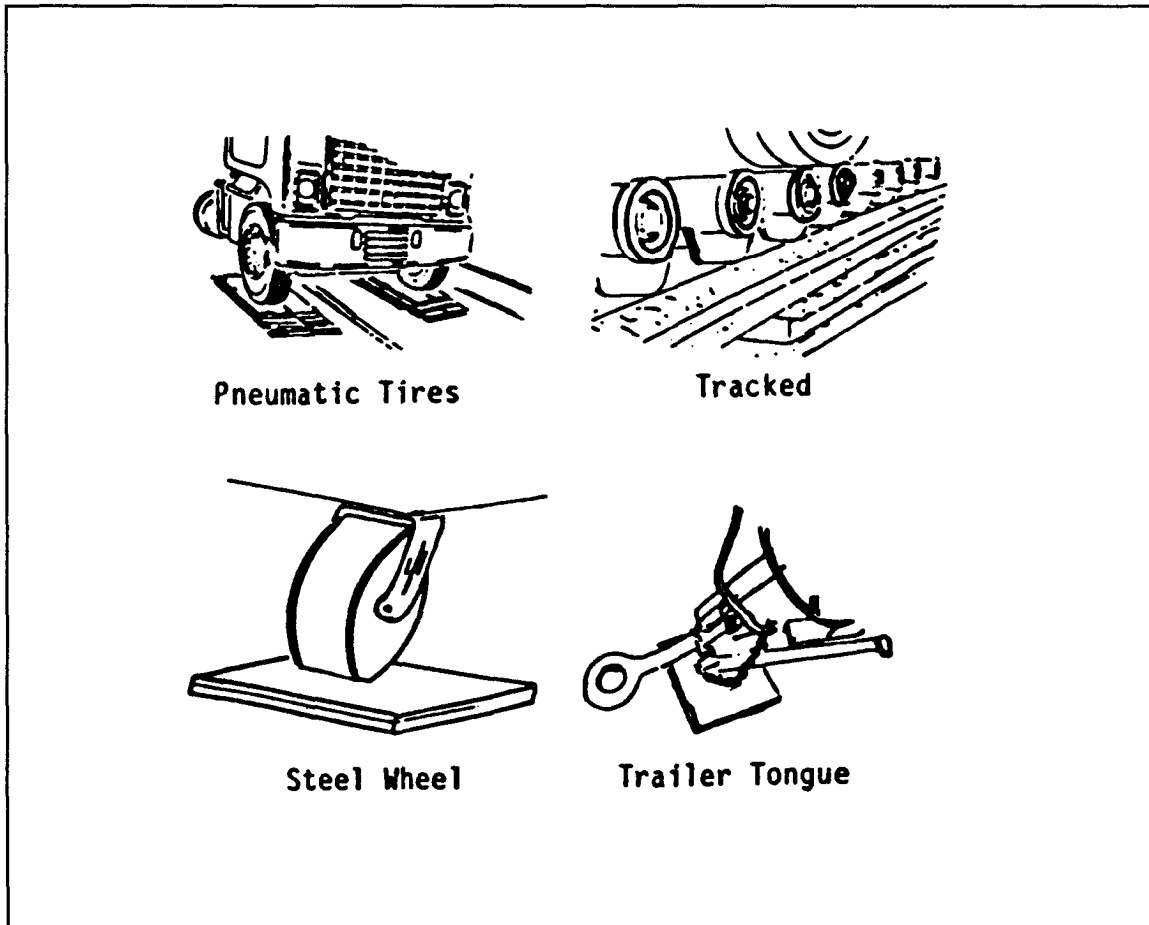

Figure A-2. Example of parking shoring.

**Bridge Shoring.** Use bridge shoring to take advantage of the greater strength of the vehicle treadways of the aircraft cargo floor. It allows the heavy cargo to be positioned between the treadways without overloading the center of the floor area. Shoring is first placed lengthwise, nose-to-tail, or laterally on the treadways. Planks or beams are positioned on top of the shoring planks and form the bridge (see Figure A-3).

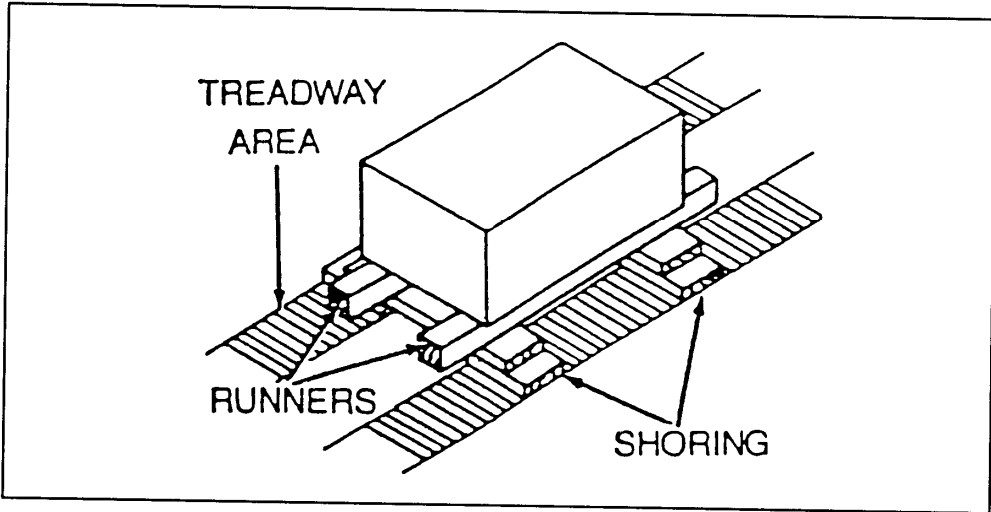

Figure A-3. Example of bridge shoring.

Sleeper Shoring. Use sleeper shoring under the frame or axle of any special-purpose vehicle (such as a forklift, scoop loader, or grader) that weighs over 20,000 pounds and has tires that are not designed for highway travel. Sleeper shoring is placed between the aircraft floor and a structured part of the vehicle, such as the frame or axle (see Figure A-4). This type of shoring prevents the vehicle from bouncing up and down and possibly pulling the tie-down rings out of the aircraft floor.

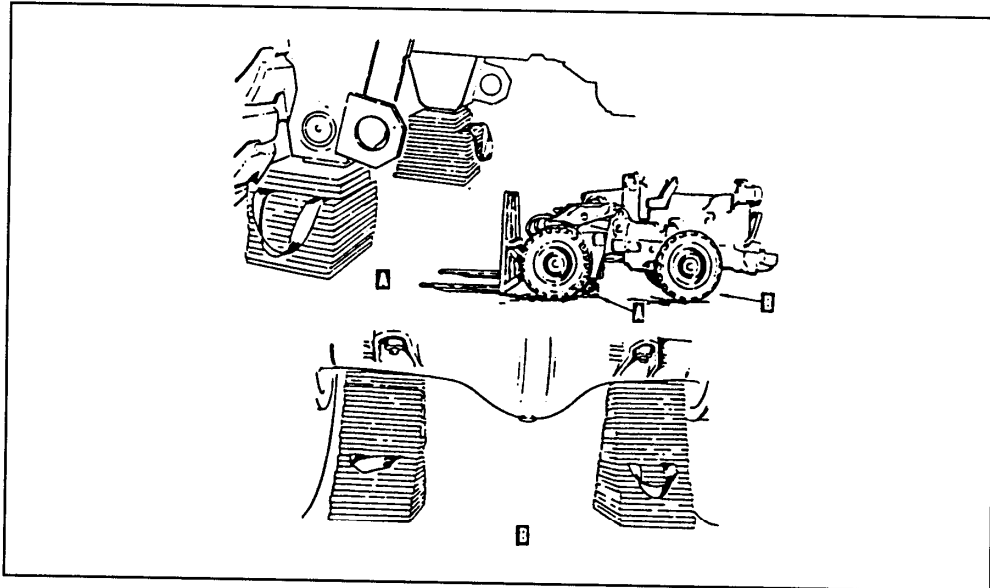

Figure A-4. Example of sleeper shoring.

**Approach Shoring.** Approach shoring, like dunnage, has specific applications. Use approach shoring to decrease the approach angle of the aircraft loading ramps (see Figure A-5). Some items of cargo will strike the aircraft or ground during loading/off-loading operations. For example, a tow pintle on a tank may strike the tarmac as the vehicle is off-loaded. Plan to transport any required approach shoring aboard the same aircraft as the item that requires the shoring.

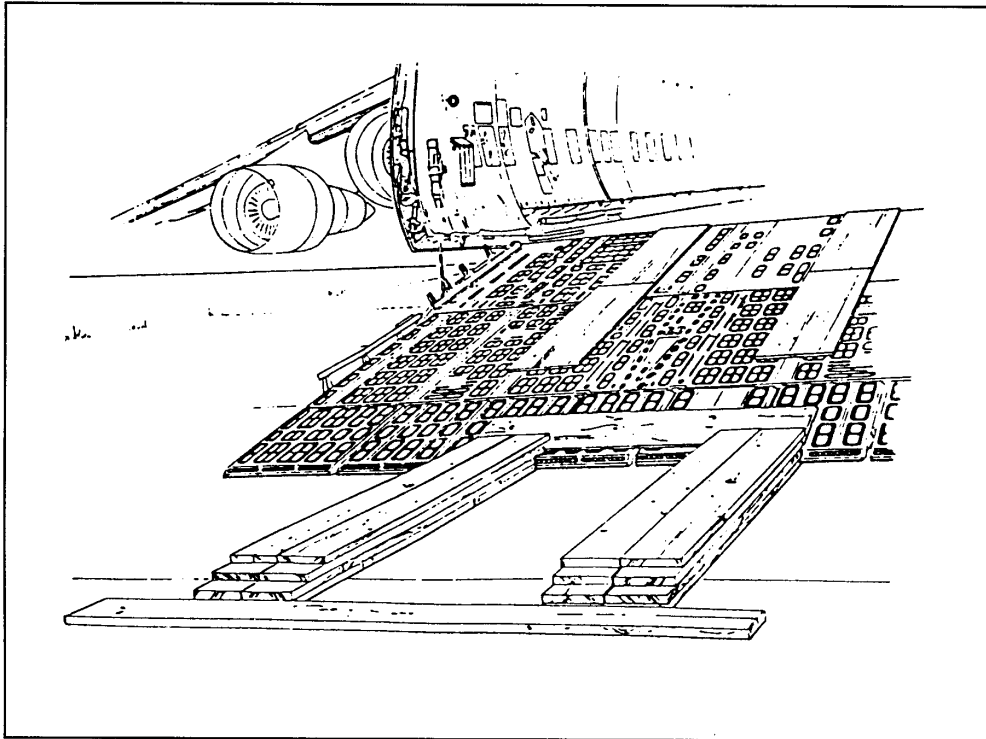

Figure A-5. Example of approach shoring.

## UNIT LOAD PLANNING PERSONNEL

**S3-Air.** The unit S3-Air officer and NCO are the primary load planners at the battalion level. They should be school trained in air movement operations from a DA approved air movement operations course. The course encompasses manual load planning and loading of cargo onto aircraft and the certification of hazardous cargo.

**Unit Air Movement Officer.** Companies will have air movement officers and/or non-commissioned officers identified as the unit air movement officer (AMO). The unit AMOs work under the guidance of the S3-Air during deployments and are responsible for the proper outloading of the equipment being deployed from their unit. Unit AMOs should also be school trained in air movement operations and must be school trained to certify hazardous cargo.

## BASICS OF AIRCRAFT LOAD PLANNING

The following basic principles of load planning apply to any type aircraft. Load planning—

- Identifies the type aircraft needed to carry a load.
- Identifies the exact number of aircraft needed to accomplish a particular mission.
- Identifies in advance any additional required loading aids to ensure availability at the equipment load time.
- Helps the unit prioritize the movement of their cargo and personnel.

Many factors must be considered in the load planning process. Primarily, the load planner must ensure the safe and efficient use of the aircraft. The load planner must comply with aircraft safety, weight, and balance, and floor load restrictions. The load must be within an acceptable center of balance condition for takeoff, flight, and landing (if not LVAD or LAPES). Computer automation has replaced much of the manual system of load planning; however, AMOs must understand the methodology of load planning. The load planner must keep other factors in mind, such as ease of on-load, and offloading, coordinating for the rigging of cargo which will be air-dropped, and the support in both manpower and logistics for outload. Improper planning can result in excessive loading or off-loading time or structural failure of the aircraft in flight or on landing.

There are two distinct phases in air movement. The first is the load planning phase. During this phase, the unit identifies aircraft requirements in terms of equipment and personnel. The unit also identifies how many aircraft and which type are required to move the unit. This phase may be repeated many times to refine the movement or to reduce the total aircraft requirement.

The second phase of movement planning is manifesting. During this phase, load planners complete the final load plans and cargo manifests. The final load plans may differ from the preplanned ones due to changes in unit movement priorities, aircraft scheduling, and actual vehicle weights at deployment time. Preliminary plans identify the overall requirement in terms of unit equipment and number and type of aircraft. During execution, the unit prioritizes movement requirements based on operational conditions at the time of the movement and on the deploying TF commander's guidance.

## TYPES OF LOADS (AIRLAND)

Aircraft loading is generally categorized into two types—concentrated loading and palletized loading. Table A-1 summarized USAF aircraft load data.

**Concentrated Loading.** Concentrated loads are very large or heavy items, such as tanks, vehicles, or construction equipment.

**Palletized Loading.** The entire aircraft load generally consists of preloaded 463L pallets, properly secured and ready for flight. The 463L restraint rail system positions and secures the pallets in the aircraft.

## THE 463L CARGO SYSTEM

The 463L system encompasses all phases of cargo loading, including material-handling equipment, cargo-loading platforms, restraint equipment, and in-aircraft systems. The 463L system is the USAF standard for moving concentrated cargo to be airlanded. It comprises the following components:

- **Dual-rail system.** The dual-rail system is installed in all airlift or 463L-capable military aircraft. This system consists of rows of rollers that allow the palletized cargo to easily move into the aircraft. Many of these rollers are stowable to convert the cargo deck to a flat, clear loading surface for wheeled or tracked cargo. The side rails guide the pallets into the aircraft and provide lateral and vertical restraint. These rails are equipped with detent locks that hold the pallet securely in place once inside the aircraft. The locks also prevent the forward and aft movement of pallets during flight.
- **463L pallet.** The 463L pallet is made of corrosion-resistant aluminum with a soft wood core and is framed on all sides by aluminum rails. The rails have 22 attached tie-down rings with six rings on each long side and five rings on each short side. Each ring has a 7,500-pound restraint capacity. The rails also have indents (notches) which are designed to accept the detent locks located on numerous types of material-handling equipment on all airlift-capable aircraft. The overall dimensions of the 463L pallet are 88 inches long by 108 inches wide by 2-1/4 inches thick. The usable dimensions of the surface area are 84 inches wide by 104 inches long. This allows two inches around the periphery of the pallet to attach straps, nets, or other restraint devices. An empty pallet weighs 290 pounds (355 pounds with nets) and has a maximum load capacity of 10,000 pounds.
- **463L pallet nets.** There are three nets to a set: one top net (yellow) and two side nets (green). The side nets attach to the rings of the 463L pallet. The top net attaches by hooks to the rings on the side nets. The nets have multiple adjustment points and can be tightened to conform to loads of almost any shape. A complete set of 463L nets provides adequate restraint for a maximum of 10,000 pounds when properly attached to a 463L pallet. A complete set of nets weighs 65 pounds.

Table A-1. USAF aircraft data.

	<b>C-130</b>	<b>C-141</b>	<b>C-17</b>	<b>C-5</b>
<b>Takeoff Gross Weight</b>				
wartime (lb)	173,700	343,000	580,000	769,000
peacetime	153,700	323,000	580,000	769,000
<b>Runway Requirements</b>				
takeoff (ft)	2,600	6,600	7,600	10,650
landing	2,700	3,840	3,000	4,610
<b>Maximum ACL (lb)</b>				
wartime	45,000	72,900	172,200	204,904
peacetime	35,000	45,000	N/A	100,000

Table A-1. USAF aircraft data (cont).

	C-130	C-141	C-17	C-5
Maximum 463L pallets	6	13	18	36
Maximum # soldiers				
wartime	92	200	N/A	340
peacetime	74	143	N/A	340
paratroopers				
wartime	80	180	102	73
in-flight rig	44	126	N/A	73
training	64	152	N/A	73
LVAD capable	yes	yes	yes	yes
LAPES capable	yes	no	no	no

## APPENDIX B

**LIGHT INFANTRY DIVISION**

The LID provides the flexibility to accomplish missions on a global basis due to its rapid deployability and ability to operate in terrain or against a threat unsuitable for armored forces. The division conducts operations exploiting the advantages of restricted terrain and limited visibility. It is composed primarily of foot-mobile soldiers who are organized, equipped, and trained to conduct combat operations involving close-in combat against light enemy forces.

In peacetime, conflicts, and war, the LID can be augmented with armored forces, or augment an armored corps. Based on the factors of METT-T, a light infantry brigade (with the appropriate CSS augmentation) can be task organized to an armored division. The division is designed to conduct autonomous operations for up to 48 hours. The LID typically has three light infantry brigades (three light battalions each) and an aviation brigade.

The LID is a light combined arms force consisting of maneuver, CS, and CSS units. The LID possesses a high density of NVD and weapon sights to optimize its ability to fight under limited visibility conditions. The LID has less firepower, both direct and indirect, than armored and mechanized divisions.

Light infantry has its primary focus on operations other than war, but it can be employed throughout all intensity levels. In the right terrain, with the appropriate mission, and when adequately augmented with additional forces and support, the division is capable of fighting heavier forces. By maximizing the capabilities of their antiarmor systems and effectively using the terrain and weather to protect their forces, LID commanders greatly increase their effectiveness on the battlefield.

Although employed as an entity, the division can disperse widely throughout a large area and conduct synchronized but decentralized operations, primarily at night or during periods of limited visibility. Mass is achieved through the combined effects of synchronized, small-unit operations and fires rather than through the physical concentration of forces on the battlefield. Without augmentation, the LID does not have the mechanized assets to close with the enemy's heavy forces in terrain suitable for mechanized operations; it is more effectively employed in terrain favoring dismounted operations, such as large urban areas, mountains, and jungles.

**DEPLOYMENT**

The LID operates as a part of a corps or a JTF. The limited amount of organic heavy equipment allows the LID to be rapidly transported by strategic air and naval forces. The LID is not designed for opposed-entry operations. Available transportation can be devoted to moving combat troops without necessitating the movement of large numbers of maintenance units. The following paragraphs describe LID deployment considerations for BOS.

**BATTLEFIELD OPERATING SYSTEMS**

**Intelligence.** These considerations apply:

- Timely and accurate intelligence of the enemy's capabilities and intentions becomes critical to the division's disposition for combat since the LID's battlefield maneuverability is limited.



- The LID commander will deploy his division on terrain that will reduce the mobility differential between enemy motorized forces and friendly dismounted forces.
- Detailed analysis of METT-T is necessary to ensure that the division is properly augmented, when appropriate. The division has limited MI assets to assist in detailed METT-T analysis.

**Maneuver.** These considerations apply:

- When engaged in combat, the LID is predominantly dismounted.
- The division's lack of mobility increases reaction time, thereby limiting battlefield maneuverability.
- Most infantry concentrations of maneuver combat power will occur prior to the start of the battle, although movement in rugged terrain is possible during conditions of reduced visibility once the battle begins.
- Light infantry units use helicopter lift or ground transportation assets, when necessary, to increase their tactical mobility.

**Fire Support.** These considerations apply:

- Divisional artillery is light, easily set up and employed, and matches the mobility and fighting characteristics of the infantry it supports.
- The LID is supported by an artillery battalion employing the 105-mm towed howitzer.

**Mobility and Survivability.** These considerations apply:

- The LID is supported by an organic light engineer battalion, often augmented by one or more equipment companies and engineer battalions from the corps engineer brigade.
- The combat engineer battalion possesses minimal digging assets, consisting of SEEs and lightweight, high-speed bulldozers.
- The secondary mission of the engineers in an LID is to fight as infantry.
- Common engineer missions in support of the LID include breaching of obstacles and minefield; constructing helicopter LZs, obstacles and strongpoints; and maintenance of supply routes.

**Air Defense.** These considerations apply:

- The LID is supported by an air defense battalion short-range air defense (SHORAD).
- Primary anti-aircraft weapons are the HMMWV-mounted Stinger and the Avenger.

**Combat Service Support.** These considerations apply

- The LID requires less logistical support than equivalent mechanized or armored units. The LID's characteristically light equipment and less complex weapon systems require less maintenance support and less favorable conditions in which to operate.
- Though the functions of the LID DISCOM are essentially the same as those of the armored and mechanized divisions, the nature of the division and the austerity of the DISCOM itself produced a unique organization and concept of support. Instead of an MSB and FSBs for each maneuver brigade, the DISCOM is composed of functional battalions: supply and transportation (S&T), medical, and maintenance. Forward companies from each functional battalion are task organized into FASTs which operate in the maneuver brigade area. Materiel management is decentralized, with the

maintenance battalion and the aviation maintenance company managing maintenance and Class IX supply. The S&T battalion manages supply (less Classes VIII and IX), and the medical company manages medical operations.

- The maintenance concept is different from that of an armored or mechanized division in that minimal intermediate (DS) maintenance is performed in the forward areas. The division depends on exchange of items and passback of repair. No significant missile repair is performed in the division area.
- Supply depends heavily on throughput resupply since DISCOM transportation assets are very limited. Preconfigured unit loads are configured in the wholesale base and stored in the COSCOM area. They consist of multiple items, required for a single purpose that can be requisitioned with a single stock number.
- In addition to support similar to that required by the heavy division, the LID CSS concept requires specific support. Corps augmentation must include a maintenance company structured to handle increased passback; a missile support team to augment the divisional support element; an aviation intermediate maintenance (AVIM) support team to provide supplemental aviation maintenance support; a supply support detachment to perform data processing beyond organic capabilities; and a mortuary affairs team designed for the LID.

**Command and Control.** These considerations apply:

- On most occasions, the LID operates where terrain or the tactical situation preclude the use of vehicles; a dismounted TAC CP is required.
- The LID possesses limited long-range communications equipment. When operating with mechanized or armored forces, the LID may operate out of radio contact.
- Communications must be carefully planned. The LID will have to receive external support when working with heavier forces.

## CAPABILITIES

The capabilities of the LID enable it to—

- Attack to defeat light enemy forces or seize terrain. If properly task organized and augmented, it can attack to defeat heavy enemy forces in close terrain.
- Conduct combat operations in contingency areas as part of a larger force, to include operations day or night, under all climatic conditions, and on any terrain.
- Reinforce forward deployed forces by full integration into their operating and support structure, particularly as an economy of force unit on close terrain. This allows mechanized and armored units the freedom for decisive employment elsewhere on the battlefield.
- Operate for 48 hours without external support.
- Conduct operations in BUAs.
- Conduct rear operations within the limits of organic tactical mobility assets.
- C2 its organic forces and any augmentation forces.
- Quickly integrate and then C2 augmentation forces, whether they are combat, CS, or CSS units.

## FM 17-18

- Participate in amphibious operations.
- Conduct air assault operations with the limits of organic aviation assets.
- Reinforce or be reinforced by combat, CS, or CSS units.
- Operate as a combined arms force with organic infantry, light armor, engineers, artillery, aviation, and air defense.

### LIMITATIONS

The LID has the following limitations:

- The LID has limited capability for NBC reconnaissance, hasty smoke production, and hasty decontamination.
- Deployment into a hostile area normally requires local air superiority, and possibly naval support.
- Tactical mobility is restricted by limited organic vehicles and aircraft.
- Organic artillery has limited range and a lack of a variety of shell and fuze combinations.
- External CSS is required after 48 hours of operations.
- The LID is extremely vulnerable to enemy heavy artillery, NBC attacks, and attacks by heavy enemy forces.

# AIRBORNE DIVISION

The airborne division is organized to deploy rapidly anywhere in the world. It is the only US division with a rapid, strategic, combined arms, opposed-entry capability. It is likely to be the initial force deployed for CONOPS. It is ideally suited to seize, secure, and repair airfields that provide an airhead for follow-on forces and to delay, disrupt, and reduce enemy forces.

The airborne division is organized in much the same way as the infantry division; however, each of its units is organized only with the equipment needed to conduct airborne assaults or airland operations. If the airborne division is to conduct sustained combat operations, it normally must be reinforced with additional medium artillery, air defense protection, and transportation.

The airborne division achieves surprise by its timely arrival on or near the battlefield. The USAF provides airlift, CAS, and aerial resupply for the airborne division. In-flight refueling capability allows the airborne force to deploy anywhere in the world without the need for staging bases close to the objective area.

## DEPLOYMENT

Airdrop operations are desirable for psychological impact or for rapid insertion of combat forces in areas where airfield capability is limited.

Because the airborne division is tailored for airdrop operations, it can be employed more rapidly than other US divisions. Most equipment is air-transportable and air-droppable. All personnel are trained for airborne operations.

The range of aircraft and the AWADS provide the USAF with the capability to accurately deliver the airborne division into virtually any objective area under almost any weather condition, with high winds and thunderstorms being the only exceptions. More combat power can be delivered by airdrop in a shorter amount of time than by any other method of insertion.

## BATTLEFIELD OPERATING SYSTEMS

As with other combat units, employment of the airborne division is a function of the applicable BOS. The following discussion focuses on the BOS used by the division while planning tactical operations.

**Intelligence.** These considerations apply:

- The commander must consider the type, number, and location of enemy air defense weapons, observation systems, and warning systems.
- Tactical air reconnaissance and aerial and satellite photographs offset the lack of terrain reconnaissance prior to an airborne operation.
- USAF CCTs and the division's long-range surveillance detachment (LRSD) are inserted early to provide HUMINT and to set up DZ control measures for the airborne assault.

## FM 17-18

- Once deployed, the division is supported by an MI battalion, which provides—
  - Signal intelligence.
  - EW.
  - Interrogation of EPW.
  - Ground surveillance.
  - Counterintelligence.

**Maneuver.** These considerations apply:

- After initial drop, the airborne force is predominantly dismounted.
- The airborne force must capitalize on surprise. OPSEC is vital to success. A force can maintain deception by masking operations as rehearsal deployments.
- Forces must fit the task. The airborne brigade TF can be part of an airborne assault by a larger unit, or it can constitute the initial assault force, preparing the way for deployment of a follow-on force.
- Rapid seizure of objectives is critical to success; speed and surprise are often more critical than numbers of troops and equipment.
- The unit conducting the airborne assault must prevent enemy direct and observed indirect fire on the airfield to ensure the safety of follow-on reinforcement forces. Air-landed elements can only be committed when these conditions are met.

**Fire Support.** These considerations may apply:

- The airborne division's organic FS is provided by the towed 105-mm howitzer. A battery usually supports a brigade.
- Airborne assault forces rely on USAF, USMC, and USN air assets and NGF, if available.
- Airborne units initially rely on CAS until division and corps artillery can support them.

**Mobility and Survivability.** These considerations may apply:

- The airborne division is supported by an organic engineer battalion, often augmented by one or more equipment companies and engineer battalions from the corps engineer brigade.
- The nature of airborne operations requires engineers to fight as infantry more often than in other operations.
- A primary mobility mission for engineers in support of airborne operations is airfield clearance and repair.
- Countermobility efforts are vital to the survival and success of an airborne force inside the airhead. Obstacles are created or reinforced to secure the airhead and to isolate it from reinforcing enemy forces.
- Survivability and fighting positions prepared from local materials are normal in airborne operations.
- The airborne division engineer unit has limited earthmoving equipment. Priority in preparing protective positions is normally given to key systems (including antiarmor), C2 facilities, and vital supplies. Corps airborne engineers have a more robust earthmoving capability.

**Air Defense.** These considerations may apply:

- An ADA battery usually supports a brigade.
- The airborne division is supported by an air defense battalion, such as a SHORAD. The battalion provides defense against low-altitude hostile aircraft and has tactical display alerting radar (TDAR) to generate early warning information.
- Primary antiaircraft weapons are the Stinger and the Avenger systems. The Vulcan may be used to provide ground fire when not required in the air defense role.

**Combat Service Support.** These considerations may apply:

- Logistical assets are organized into DISCOM BSA. Each team is tailored to meet the needs of the supported force and is organized around a forward support maintenance company and a forward medical company.
- Logistical assets are deployed in echelons along with the deploying airborne force. These include—
  - Assault echelon. This is all or a portion of the FAST as determined by the commander's concept of the operation. It is normally attached to the deploying brigade and is part of the assaulting unit.
  - Follow-on echelon. Most of the DISCOM enters the AO in the follow-on echelon, normally via airland operations deployment.
  - Rear echelon. CSS assets in this echelon remain at the departure airfield or ISB. They are elements not immediately required in the airhead.
- Transportation is severely limited in airborne units. Aerial resupply methods via airdrop or slingload are maximized.

**Command and Control.** These considerations may apply:

- Unity of command is vital and takes precedence over other C2 considerations. Both air and ground units must be under one overall commander. The senior officer in the landing area commands the airhead until the arrival of the ground force commander. Establishment of the shortest possible chain of command is critical to success.
- Airborne divisions must execute missions rapidly. Contingency plans are formulated and continuously updated based on the most current intelligence. Advanced planning can allow more rapid decision making and timely commitment of forces.
- Effective communications plans are critical for success in the airborne assault phase. Leaders carry their own radios in any airborne assault until the tactical situation stabilizes and allows for radiotelephone operators.
- Rehearsals are vital to success. Every paratrooper must fully understand the plan and the commander's intent. Briefbacks at all levels are essential in airborne operations.
- Commanders must be flexible. They must anticipate operating with fewer resources than planned due to casualties and damaged or destroyed equipment.
- Liaisons are required continuously with other JTFs.

## CAPABILITIES

The capabilities of the airborne division enable it to—

- Conduct opposed-entry operations.
- Conduct combat operations against light enemy forces day or night, under all climatic conditions, and on any terrain.
- Conduct operations in BUAs.
- Conduct air assaults within the limits of organic aviation assets.
- Conduct combined arms combat parachute assaults to seize and secure vital objectives behind enemy lines and link up with other supporting forces.
- Capture one or more intermediate staging bases or forward operating bases for ground and air operations.
- Seize an advance base to further enhance deployment of forces or to deny use of the base by the enemy.
- Reinforce units beyond the immediate reach of land forces.
- Reinforce threatened areas or flanks.
- Exploit the effects of nuclear or chemical weapons.
- Rescue US nationals from dangerous situations.
- Deny the enemy key terrain or routes.
- Serve as a strategic or theater reserve.
- Conduct large-scale tactical raids.
- Provide a show of force.
- Conduct economy-of-force operations to free heavier, more tactically mobile units for other assignments.
- Execute various missions in operations other than war.

## LIMITATIONS

Limitations in employing the airborne division include the following:

- Airborne forces must rely on USAF tactical or strategic airlift for initial entry into battle, making them vulnerable to enemy attack while en route to the DZ. Although the USAF can conduct limited airdrops without air superiority, large operations require neutralization or suppression of enemy air defenses.
- Once on the ground, the airborne force has limited tactical mobility. Only light armor units and antitank units deployed with the force have significant mobility assets. Otherwise, the airborne force's mobility depends on the number and types of vehicles and helicopters that can be brought into the objective area to move dismounted soldiers.

- The division has limited FA and ADA support until additional assets can be introduced into the objective area. Additional target acquisition assets are needed to provide accurate and timely targeting information.
- Evacuation of casualties from the airhead is difficult. Until evacuation means are available, the division must provide its own medical care.



## APPENDIX D

**AIR ASSAULT DIVISION**

The air assault division combines strategic mobility with an extremely high degree of tactical mobility within its AO. The division conducts air assault operations by combining Army aviation and infantry units with other members of the combined arms team; these elements form powerful, and flexible air assault TFs that can project combat power throughout the entire depth, width, and breadth of the modern battlefield with little regard for terrain barriers. The air assault division can be employed in peace, conflict, or war.

The air assault division can be employed as part of an independent corps or a JTF. The division operates from a position on the battlefield that allows its mobility to be used to its advantage throughout the assigned AO. It is employed under conditions that provide it with a calculated advantage due to surprise, terrain, threat, or mobility.

Airmobile divisions provide the US Army with the operational foundation, experience, and tactics for air assault operations; however, the air assault division no longer merely conducts airmobile operations. It is important to recognize the distinction between airmobile and air assault.

Airmobility is the use of Army aircraft whenever and however they improve the ability to fight. Essentially, it involves movement of troops and equipment from one secure area to another; the helicopters depart the AO after insertion.

Air assault operations involve combat, CS, and CSS elements (aircraft and troops) deliberately task organized for tactical operations. Aviation is the prime mover, and aircraft are integrated with ground forces. Air assault operations generally involve insertions and extractions under hostile conditions, rather than air movement of troops to and from secure locations about the battlefield in airmobile operations.

Once deployed on the ground, air assault infantry battalions fight like those of the infantry division; however, normal task organization of organic aviation assets permits rapid aerial deployment. The essence of air assault tactics is rapid tempo of operations over extended ranges. Execution of successive air assault operations enables the division commander to seize and maintain the tactical initiative.

**DEPLOYMENT**

The air assault division deploys much like an LID. The lack of heavy equipment permits the division to assemble rapidly and deploy by air on short notice. The division's aviation assets may self-deploy or be transported to the AO via USAF aircraft.

The air assault division deploys into contingency scenarios usually by moving to its ISB or lodgement area near the AOs via USAF aircraft. The division rapidly establishes support facilities primarily for the aviation assets and then launches into the AO.

**BATTLEFIELD OPERATING SYSTEMS**

As with other combat units, employment of the air assault division is a function of the applicable BOS. The following discussion focuses on the BOS used by the division while planning tactical operations.

**Intelligence.** These considerations apply:

- The primary enemy tactics against air assault operations can be broken down into four major areas:
  - Air defense fires (including small arms).
  - Fixed and rotary-wing aircraft.
  - EW.
  - Enemy reaction to LZ operations.
- The capabilities and limitations of enemy aircraft within the AO must be understood, and all measures to minimize the risk of encounter must be taken.

Enemy EW capabilities that would influence the air assault operations (to include jamming, direction-finding and monitoring of communications, or jamming and direction-finding involving friendly radars) must be determined and appropriate electronic countermeasures employed.

- Analysis of enemy capabilities to interdict friendly LZs with ground forces, artillery, and CAS must be accomplished during the planning phase of the operation.
- The IPB process is especially important to the air assault division because of the division's capability for extended distances and 360-degree orientation.

**Maneuver.** These considerations apply:

- Habitual relationships and the integration of infantry and Army aviation allow infantrymen and supporting fires to strike rapidly over extended distances.
- The organic aviation assets of the division can normally insert, at one time, an infantry brigade (-) or two battalion TFs (+).
- The required combat power should be delivered to the objective area as early as possible, consistent with aircraft and pickup zone (PZ) capabilities, to provide surprise and shock effect.
- Attack helicopter battalions are used primarily in an antiarmor role and are integrated into the tactical plan of the ground force commander.
- Air assault forces operate relatively free of the terrain influences that restrict surface operations.
- The force must be tailored to provide en route security and protection at the PZ, throughout the entire flight route, and at the LZ.
- Air assault forces are best employed to locate and defeat enemy forces and installations or to seize terrain objectives, thereby preventing enemy withdrawal, reinforcement, and supply and the shifting and reinforcement of enemy reserves.

**Fire Support.** These considerations apply:

- The FS planning must provide for suppressive fires along flight routes and in the vicinity of LZs. Priority of fires must be the suppression of enemy air defenses (SEAD).
- The division is supported by an artillery battalion consisting of 105-mm towed howitzers.

- Displacement of FS assets and resupply is dependent on helicopters for prime movers, unless prime movers are lifted into the area.
- Suppression of suspected ADA sites along flight routes is vital to the success of an air assault operation.
- NGF support and USAF CAS may be available to augment the division's organic FA assets especially during CONOPS in which there are limited ground-based artillery assets.

**Mobility and Survivability.** These considerations apply:

- The division is supported by an organic air assault engineer battalion, often augmented by one or more equipment companies and engineer battalions from the corps engineer brigade.
- Engineers in an air assault division assist mobility by constructing or expanding helicopter LZs, forward arming refuel points (FARP), LAPES, and landing strips and by maintaining, repairing, and rehabilitating existing forward aviation maintenance sights.
- Engineers assist in breaching obstacles and fight as infantry when required.

**Air Defense.** These considerations apply:

- The division is supported by an ADA battalion consisting of SHORAD, such as Avenger and Stinger systems.
- ADA assets provide protection against low-flying aircraft and attack helicopters.
- Early warning will be broadcast over the division early warning net. The air defense battalion will use six early warning radars throughout the division sector.
- Stinger MANPADS sections will be used primarily to support maneuver units. Avengers will be used to protect C2, FAST, and static assets.

**Combat Service Support.** These considerations apply:

- Traditional doctrinal distances and responsibilities do not always apply to air assault operations. The logistical system is tailored to be supported by air, and is therefore dependent on considerable external support.
- A brigade-size TF must rely on an FSB to support its operation.
- The air assault TF is supported by organic assets to push supplies, material, fuel, and ammunition forward by helicopter slingload operations.
- Support of organic aviation units is extensive. FARPs are necessary to maintain the fast pace of air assault operations.

**Command and Control.** These considerations apply:

- Since the battlefield over which the air assault TF operates may extend well beyond normal size, special considerations must be given to the C2 of air assault operations.
- The key to successful air assault operations lies in precise, centralized planning and aggressive, decentralized execution. Successful air assault C2 depends on—
  - Effective task organization. All assets must be tailored into discrete, task organized elements, each with two-way radio communications, unity of command, clearly defined missions and objectives, and provisions for maintaining unit integrity throughout the operation.

## FM 17-18

- Precise planning. Operations must be planned to occur at a specified time or in a specified sequence (event driven, time driven) despite degraded communications or other adverse conditions.
- Decentralized control. Subordinate commanders should be given the maximum possible freedom of action to ensure mission accomplishment.
- Establishment of air assault radio nets. Radio nets to facilitate ground-to-ground, air-to-air, and ground-to-air communications are established to provide for timely flow of information and redundancy in capability.
- The availability of aviation assets is normally the major factor in determining task organization. Task organization must be determined and announced early in the planning process.
- Unit tactical integrity must be maintained throughout an air assault operation. Squads are normally loaded intact on the same helicopter to ensure unit integrity upon landing.

### CAPABILITIES

The capabilities of the air assault division enable it to—

- Conduct deep attacks and raids beyond the FLOT or LC, using helicopters to insert and extract forces.
- React rapidly to tactical opportunities and necessities; conduct exploitation and pursuit operations.
- Rapidly secure and defend key terrain (such as crossing sites, road junctions, and bridges) or deep objectives.
- Conduct operations under adverse weather conditions and at night to facilitate deception and surprise.
- Provide responsive reserves, allowing commanders to commit a larger portion of their forces to action.
- Overfly or bypass barriers and obstacles and strike objectives in otherwise inaccessible areas.
- Rapidly concentrate, disperse, or redeploy to extend the area of influence.
- Rapidly place forces at tactically decisive points in the battle area.
- Delay a much larger force without becoming decisively engaged.
- Conduct fast-paced operations over extended distances.
- Conduct economy-of-force operations over a wide area.
- Provide surveillance or screen over a wide area.
- Attack enemy positions from any direction.
- Bypass enemy positions; achieve surprise.
- Rapidly reinforce committed units.
- React to rear area threats.

## LIMITATIONS

Factors that can limit the effectiveness of the air assault division include—

- Adverse weather, extreme heat and cold, and other environmental conditions such as blowing snow and sand that limit flight operations and helicopter lifting capability.
- Relative lack of NBC protection and decontamination capability.
- Reduced vehicle-mounted antitank weapon systems (except in air assault units).
- Availability of suitable LZ and PZ.
- Enemy aircraft, air defense, and EW action.
- High fuel (JP4) and ammunition consumption rates.
- Battlefield obscuration that limits helicopter flight.
- Reliance on air LOC.
- Reduced ground mobility once inserted.

## FRATRICIDE REDUCTION

The problem of fratricide is as old as warfare itself. It is a complex problem that defies simple solutions. Fratricide is defined as “the employment of friendly weapons and munitions, with the intent to kill the enemy or destroy his equipment or facilities that results in unforeseen and unintentional death or injury to friendly personnel.” This appendix focuses on actions leaders can take with current resources to reduce the risk of fratricide.

### MAGNITUDE OF THE PROBLEM

The modern battlefield is more lethal than any in history. The pace of operations is rapid, and the nonlinear nature of the battlefield creates C2 challenges for all unit leaders.

Our ability to acquire targets using thermal imagery exceeds our ability to accurately identify targets as friend or foe. The accuracy and lethality of modern weapons make it possible to engage and destroy targets at these extended acquisition ranges.

Added to this is the problem of battlefield obscuration. Rain, dust, fog, smoke, and snow degrade the ability to identify targets by reducing the intensity and clarity of thermal images. The effects of battlefield obscuration must be considered when thermal identification is relied upon.

On the battlefield, positive visual identification cannot be the sole engagement criteria at ranges beyond 1,000 meters. Situational awareness is key and must be maintained throughout an operation.

The following are recommended actions to take at crew and leader level in the event the crew are victims of friendly fires:

- React to contact until you recognize friendly fire.
- Cease fire.
- Report on the next higher unit net—
  - That you are receiving friendly fire.
  - The location and direction of the firing vehicle.
- Provide a visual recognition signal to cease fire.
- Protect troops, request medical assistance as needed.
- Do not return fire if you identify the firing unit as friendly.

The following are recommended actions to take at crew and leader level when the crew are engaging friendly forces:

- Cease fire.
- Report on next higher net—
  - The engaged friendly force (if unknown, report number and type of vehicles).
  - The location.
  - The direction and distance to victim.
  - The type of fire.
  - The target effects.

## FM 17-18

The following are recommended actions to take at crew and leader level in the event the crew observes a friendly fire incident:

- Seek cover and protect self.
- Report on next higher net—
  - The friendly force engaged
  - The location of the incident.
  - The direction and distance to victim/firer.
  - The type of fire.
  - The target effects.
- Provide a visual friendly recognition signal.
- Provide assistance (when safe to do so) as needed.

Leader actions should focus on identifying and stopping the friendly fire incident and establishing controls to prevent its recurrence. Some recommended actions for identifying and stopping friendly fire incidents are—

- Find and stop firing.
- Conduct in-stride risk assessment.
- Implement controls to preclude recurrence.

## PREVENTIVE MEASURES

Reduction of fratricide risk begins with the planning phase of an operation and continues through the execution of the operation. The following are considerations for identifying fratricide risks in the planning, preparation, and execution phases of a given operation:

- Planning phase. A good plan that is well understood helps to minimize fratricide risk. The following considerations help indicate the potential for fratricide in a given operation:
  - The clarity of the enemy situation.
  - The clarity of the friendly situation.
  - The clarity of the commander's intent.
  - The complexity of the operation.
  - The planning time available to all levels.
- Preparation phase. The following additional fratricide risks may become evident during rehearsals:
  - Number and type of rehearsals.
  - Training and proficiency levels of unit/individuals.
  - The habitual relationships between units conducting the operation.
  - The endurance of the troops conducting the operation.

- Execution phase. During execution, in-stride risk assessment and reaction are necessary to overcome unforeseen fratricide risk situations. The following are factors to consider when assessing fratricide risks:
  - Intervisibility between adjacent units.
  - Amount of battlefield obscuration.
  - Ability or inability to positively identify targets.
  - Equipment similarities and dissimilarities between enemy and friendly vehicles.
  - Vehicle density on the battlefield.
  - The tempo of the battle.

Graphics are a basic tool that commanders at all levels use to clarify their intent, add precision to their concept, and communicate their plan to subordinates. As such, graphics can be a very useful tool in reducing the risk of fratricide. Commanders at all levels must understand the definitions and purpose of operational graphics and the techniques of their employment. See FM 100-5-1 for the definitions of each type of graphic control measure.

Briefbacks and rehearsals are primary tools in identifying and reducing fratricide risk. The following are some considerations on briefbacks and rehearsals to aid in reducing fratricide:

- Briefbacks ensure subordinates understand commander's intent. They often highlight areas of confusion, complexity, or planning errors.
- The type of rehearsal conducted impacts on the risks identified.
- Rehearsals should extend to all levels of command and involve all key players.
- Use briefbacks or rehearsals to ensure subordinates know where fratricide risks exist, and what to do to reduce or eliminate the risk.

Maintaining situational awareness at all levels is key to fratricide reduction. Units must develop techniques to gain and maintain situational awareness in SOPs. Techniques could include—

- Eavesdropping on next higher net.
- Cross talk on radio between units.
- Accurate position reporting and navigation.
- Training and use/exchange of LOs.

Risk assessment must be conducted at all levels during the planning, preparation, and execution phases of all operations. Identification of fratricide risk factors is conducted at every level and the results should be clearly communicated up and down the chain of command.

Figure E-1 on page E-5 provides a worksheet for considering fratricide risk in the context of mission requirements. The worksheet lists six mission-accomplishment factors that affect the risk of fratricide. Assess the potential risk in each area as low, medium, or high, and assign a point value to each (one point for low risk, two for medium risk, three for high risk). Add the point values for the overall fratricide assessment score. Use the resulting score only as a guide, however. Your final assessment must be based both on observable risk factors like those on the worksheet and on your "feel" for the intangible factors affecting the operation. Note that descriptive terms are listed only in the low- and high-risk



columns of the worksheet. Your assessment of each factor will determine whether the risk matches one of these extremes or lies somewhere between them as a medium risk.

The following fratricide reduction measures are provided as reminders for prudent/appropriate actions to reduce fratricide risk. They are not directive in nature, nor intended to restrict initiative. Apply the following measures to METT-T situations as appropriate:

- Identify and assess potential fratricide risk in the estimate of the situation. Express this risk in the OPORD or FRAGO.
- Maintain situational awareness-current intelligence; unit locations/dispositions; denial areas (minefields/FASCAM); contaminated areas, such as ICM and NBC; SITREPs; and METT-T.
- Ensure positive target identification. Review vehicle/weapons identification (ID) cards. Know at what ranges and under what conditions positive ID of friendly vehicles/weapons is possible.
- Establish a command climate that stresses fratricide prevention. Enforce fratricide prevention measures; use doctrinally sound tactics, techniques, and procedures to ensure constant supervision of execution of orders and performance to standards.
- Recognize the signs of battlefield stress. Take quick effective action to deal with it to maintain unit cohesion.
- Conduct individual and collective (unit) fratricide awareness training; target identification/recognition training; fire discipline; and leader training.
- Develop a simple decisive plan.
- Give complete and concise mission orders.
- Use SOPs that are consistent with doctrine to simplify mission orders. Periodically review and change SOPs as needed.
- Strive for maximum planning time for you and your subordinates.
- Use common language/vocabulary and doctrinally correct standard terminology and control measures, such as, FSCL, zone of engagement, RFL, and others.
- Ensure thorough coordination is performed.
- Plan for and establish good communications.
- Plan for collocation of CPs, as appropriate to the mission, for example, passage of lines.
- Establish and designate LOs as appropriate.
- Make sure ROE are clear.
- Consider the effect of fratricide on key elements of terrain analysis (OCOKA).
- Conduct rehearsals whenever the situation allows time to do so.
- Be in the right place at the right time. Use position location/navigation (GPS) devices; know your location and the locations of adjacent units (left, right, leading and follow on); and synchronize tactical movement.
- Include fratricide incidents in after-action reviews (AAR).

## **FRATRICIDE RISK CONSIDERATIONS**

This format, which parallels the five-paragraph OPORD, contains key factors and considerations in fratricide reduction. This is not a change to the OPORD format; rather, it should be used during OPORD development to ensure fratricide reduction measures are included in the order. It is not a strict guide. The factors and considerations are listed

where they would likely appear in the OPORD, but they may warrant evaluation during preparation of other paragraphs.

1. Situation.

a. Enemy forces.

- (1) Are there similarities between enemy and friendly equipment and uniforms that could lead to fratricide?
- (2) What languages do enemy forces speak? Could these contribute to fratricide risk?
- (3) What are the enemy's deception capabilities and its past record of deception activities?
- (4) Do you know the locations of enemy forces?

b. Friendly forces.

- (1) Among the allied forces, are there differences (or similarities with enemy forces) in language, uniform, and equipment that could increase fratricide risk during combined operations?
- (2) Could differences in equipment and uniforms among US armed forces increase fratricide risk during joint operations?
- (3) What differences in equipment and uniforms can be stressed to help prevent fratricide?
- (4) What is the friendly deception plan?
- (5) What are the locations of your unit and adjacent units (left, right, leading, follow-on)?
- (6) What are the locations of neutrals and noncombatants?

c. Own forces.

- (1) What is the status of training activities? What are the levels of individual, crew, and unit proficiency?
- (2) Will fatigue be a factor for friendly forces during the operation? Has an effective sleep plan been developed?
- (3) Are friendly forces acclimatized to the AO?
- (4) What is the age (new, old, or mix) and condition of equipment in friendly units? What is the status of new equipment training (NET)?
- (5) What are the expected MOPP requirements for the operation?

d. Attachments and detachments.

- (1) Do attached elements know the above information regarding enemy and friendly forces?
- (2) Are detached elements supplied the above information by their gaining units?

e. Weather.

- (1) What are the expected visibility conditions (light data and precipitation) for the operation?
- (2) What effect will heat and cold have on troops, weapons, and equipment?

FACTORS	LOW (1)	MEDIUM (2)	HIGH (3)
<b>1. UNDERSTAND PLAN</b> - Commander's Intent - Complexity - Enemy Situation - Friendly Situation - ROE	Clear Simple Known Clear Clear		Foggy Complex Unknown Unclear Unclear
<b>2. ENVIRONMENT</b> - Intervisibility - Obscuration - Battle tempo - Positive target ID	Favorable Clear Slow 100%		Unfavorable Obscured Fast 0%
<b>3. CONTROL MEASURES</b> - Command relationships - Audio - Visual - Graphic - SOPs - LOs - Location/Navigation	Organic Loud/Clear Well Seen Standard Standard Proficient Sure		Joint/Combined Jammed Obscured Not understood Not used Untrained Unsure
<b>4. EQUIPMENT (Compared to US)</b> - Friendly - Enemy	Similar Different		Different Similar
<b>5. TRAINING</b> - Individual proficiency - Unit proficiency - Rehearsal - Habitual relationship - Endurance	MOS Qual Trained Multiple Yes Alert		Untrained Untrained None No Fatigued
<b>6. PLANNING TIME (1/3 -2/3 Rule)</b> - Higher HQ - Own HQ - Lower HQ	Adequate Adequate Adequate		Inadequate Inadequate Inadequate
<b>OVERALL FRATRICIDE ASSESSMENT</b>	LOW 26-46%*	MEDIUM 42-62%*	HIGH 58-78%*
* Commander may use numbers as the situation dictates. Numbers alone may not give accurate fratricide risk.			

f. Terrain.

(1) Do you know the topography and vegetation (such as urban, mountains, hilly, rolling, flat, desert, swamp/marsh, prairie/steppe, jungle, dense forest, open woods) of the expected AO?

(2) Have you evaluated the terrain using the factors of OCOKA?

2. Mission. Is the mission, as well as all associated tasks and purposes, clearly understood?

3. Execution.

a. Task organization.

(1) Has the unit worked under this task organization before?

(2) Are SOPs compatible with the task organization (especially with attached units)?

(3) Are special markings or signals (for example, cats' eyes, chemlites, or panels) needed for positive identification of uniforms and equipment?

(4) What special weapons and/or equipment are to be used? Do they look or sound like enemy weapons and/or equipment?

b. Concept of the operation.

(1) Maneuver. Are main and supporting efforts identified to ensure awareness of fratricide risks and prevention?

(2) Fires (direct and indirect).

(a) Are priorities of fires identified?

(b) Have target lists been developed?

(c) Has the fire execution matrix/overlay been developed?

(d) Have locations of denial areas (minefields/FASCAM) and contaminated areas (ICM, NBC) been identified?

(e) Are the locations of all supporting fires targets identified in the OPOD/OPLAN overlays?

(f) Are aviation and CAS targets clearly identified?

(g) Has the direct-fire plan been developed?

(h) Have final protective fires (FPF) been designated?

(i) Have you identified and verified sector limits?

(3) Engineer tasks.

(a) Are friendly minefield, including FASCAM and ICM dud-contaminated areas, known?

(b) Are obstacles identified, along with the approximate time needed for reduction/breaching of each?

(4) Tasks to each subordinate unit. Are friendly forces identified, as appropriate, for each subordinate maneuver element?

(5) Tasks to CS/CSS units. Have locations of friendly forces been reported to CS/CSS units?

(6) Coordinating instructions.

- (a) Will a rehearsal be conducted? Is it necessary? Are direct and indirect fires included?
- (b) Is a briefback necessary?
- (c) Are appropriate control measures clearly explained and illustrated in the OPORD and overlays? Have they been disseminated to everyone who has a need to know? What is the plan for using these control measures to synchronize the battle and prevent fratricide?
- (d) Have target/vehicle identification drills been practiced?
- (e) Do subordinate units know the immediate action, drill, or signal for “cease fire” or “I am friendly” if they come under unknown or friendly fire? Is there a backup action?
- (f) Is guidance in handling dud munitions, such as ICMs and CBU, included?

4. Service Support.

- a. Are train locations and identification markings known by everyone?
- b. Do medical and maintenance personnel know the routes between train units?

5. Command and Signal.

a. Command.

- (1) What is the location of the commander and key staff?
- (2) What is the chain of command?

b. Signal.

- (1) Do instructions include signals for special and emergency events?
- (2) Do instructions include how to identify friendly forces to aircraft?
- (3) Do instructions include backup code words and visual signals for all special and emergency events?
- (4) Are SOI distributed to all units with a need to know, such as higher, lower, adjacent, leading, and follow-on?

## GLOSSARY

## A

<b>A2C2</b>	Army airspace command and control	<b>AGOSOP</b>	air-ground operations standard operating procedures
<b>AA</b>	assembly area	<b>AH</b>	attack helicopter
<b>AAA</b>	antiaircraft artillery	<b>AI</b>	air interdiction
<b>AACG</b>	arrival airfield control group	<b>AIL</b>	administrative/logistics
<b>AAFAD</b>	all arms for air defense	<b>ALCE</b>	airlift control element
<b>AALPS</b>	automated air loading planning system	<b>ALO</b>	air liaison officer
<b>AAR</b>	after-action review	<b>AM</b>	alternating modulation
<b>ABC</b>	air battle captain	<b>AMC</b>	air mission commander
<b>ABCC</b>	airborne battlefield command and control center	<b>AMO</b>	air movement officer
<b>abn</b>	airborne	<b>ANGLICO</b>	air and naval gunfire liaison company
<b>ACA</b>	airspace coordination area	<b>AO</b>	area of operations
<b>ACC</b>	air component commander	<b>AOC</b>	air operations center
<b>ACE</b>	armored combat earthmover	<b>AOE</b>	authorized organizational equipment
<b>ACL</b>	allowable cargo load	<b>AOT</b>	air tasking order
<b>ACT</b>	air cavalry troop	<b>AP</b>	antipersonnel (mine)
<b>ADA</b>	air defense artillery	<b>APC</b>	armored personnel carrier
<b>ADACG</b>	arrival/departure airfield control group	<b>APERS</b>	antipersonnel (ammunition)
<b>ADCOORD</b>	air defense coordinator	<b>APFSDS</b>	armor-piercing stabilized discarding sabot
<b>AF</b>	Air Force	<b>API</b>	armor-piercing incendiary
<b>AFAC</b>	airborne forward air controller	<b>ASL</b>	authorized stockage list
<b>AFV</b>	armored fighting vehicle	<b>aslt</b>	assault
<b>AG</b>	adjutant general	<b>ASOC</b>	air support operations center
<b>AGL</b>	above ground level	<b>ASP</b>	ammunition supply point
<b>AGM</b>	air-to-ground missile	<b>AT</b>	antitank
		<b>ATGM</b>	antitank guided missile
		<b>ATHS</b>	automatic target hand-off system
		<b>ATP</b>	ammunition transfer point
		<b>AVIM</b>	aviation intermediate maintenance

<b>AVLB</b>	armored vehicle launched bridge
<b>AWACS</b>	airborne warning and control system
<b>AWADS</b>	adverse weather aerial delivery system
<b>AXP</b>	ambulance exchange point

**B**

<b>BAI</b>	battlefield air interdiction
<b>BAS</b>	battalion aid station
<b>BDA</b>	battle damage assessment
<b>BDAR</b>	battle damage assessment and repair
<b>BHL</b>	battle handover line
<b>BII</b>	basic issue items
<b>BMO</b>	battalion maintenance officer
<b>BMT</b>	battalion maintenance team
<b>BOS</b>	battlefield operating systems
<b>BP</b>	battle position
<b>BSA</b>	brigade support area
<b>BUA</b>	built-up areas

**C**

<b>C2</b>	command and control
<b>C2 node</b>	command and control junction
<b>C3</b>	command, control, and communications
<b>CA</b>	counterair
<b>CAB</b>	combat aviation brigade
<b>CARP</b>	computed air release point
<b>CAS</b>	close air support
<b>CBU</b>	cluster bomb unit
<b>CCT</b>	combat control team
<b>CDS</b>	container delivery system

<b>CE</b>	communications -electronics
<b>CEB</b>	clothing exchange and bath
<b>CESO</b>	communications electronics signal officer
<b>CEV</b>	combat engineer vehicle
<b>CFA</b>	covering force area
<b>CFL</b>	coordinated fire line
<b>CH</b>	cargo helicopter
<b>CI</b>	counterintelligence
<b>CINC</b>	Commander in Chief
<b>CLACC</b>	central loading area control center
<b>CL V</b>	Class V (in illustration)
<b>CMO</b>	civil-military operations
<b>CMT</b>	company maintenance team
<b>COA</b>	courses of action
<b>COLT</b>	combat observation lasing team
<b>commo</b>	communications
<b>COMSEC</b>	communications security
<b>CONOPS</b>	contingency operations
<b>CONPLAN</b>	contingency plan
<b>CONUS</b>	continental United States
<b>COSCOM</b>	corps support command
<b>CP</b>	command post
<b>CPX</b>	command post exercise
<b>CRC</b>	control and reporting center
<b>CRP</b>	control and reporting post
<b>CS</b>	combat support
<b>CSM</b>	command sergeant major
<b>CSR</b>	controlled supply rate
<b>CSS</b>	combat service support
<b>CTA</b>	common table of allowances
<b>CTCP</b>	combat trains command post
<b>CVC</b>	combat vehicle crewman

D	
<b>D-day</b>	deployment day
<b>DA</b>	Department of the Army
<b>DACG</b>	departure airfield control group
<b>DACO</b>	departure airfield control officer
<b>DAO</b>	division ammunition office
<b>DF</b>	direction finding
<b>DISCOM</b>	division support command
<b>DIVARTY</b>	division artillery
<b>DLIC</b>	detachment left in contact
<b>DMCC</b>	division movement control center
<b>DMMC</b>	division materiel management center
<b>DNVT</b>	digital nonsecure voice terminal
<b>DP</b>	decision point
<b>DPICM</b>	dual-purpose improved conventional munition
<b>DRB</b>	division ready brigade
<b>DRF</b>	division ready force
<b>DS</b>	direct support
<b>DSA</b>	division support area
<b>DST</b>	decision support template
<b>DSVT</b>	digital subscriber voice terminal
<b>DTG</b>	date-time group
<b>DTOC</b>	division tactical operations center
<b>DZ</b>	drop zone
<b>DZST</b>	drop zone support team

E	
<b>EA</b>	engagement area
<b>EBA</b>	engineer battlefield assessment
<b>ECM</b>	electronic countermeasures
<b>EDRE</b>	emergency deployment readiness exercise
<b>EEFI</b>	essential elements of friendly information
<b>EOC</b>	emergency operations center
<b>EPW</b>	enemy prisoner of war
<b>ESIP</b>	equipment supply issue point
<b>ETAC</b>	enlisted terminal attack controller
<b>EW</b>	electronic warfare
F	
<b>FA</b>	field artillery
<b>FAAD</b>	forward area air defense
<b>FAAO</b>	field artillery air observer
<b>FAAR</b>	forward area alerting radar
<b>FAC</b>	forward air controller
<b>FAC-P</b>	forward air control post
<b>FAE</b>	fuel-air explosive
<b>FARP</b>	forward arming refuel point
<b>FASCAM</b>	family of scatterable mines
<b>FAST</b>	forward area support team
<b>FAX</b>	facsimile
<b>FCP</b>	firepower control parties
<b>FCT</b>	firepower control team
<b>FDC</b>	fire direction center
<b>FCP</b>	firepower control parties
<b>FCT</b>	firepower control team
<b>FDC</b>	fire direction center

<b>FEBA</b>	forward edge of battle area
<b>FFAR</b>	folding fin aircraft rocket
<b>ISG</b>	first sergeant
<b>FIST</b>	fire support team
<b>FISTV</b>	fire support team vehicle
<b>FLIR</b>	forward looking infrared
<b>FLOT</b>	forward line of own troops
<b>FM</b>	field manual; frequency modulation
<b>FO</b>	forward observer
<b>FOB</b>	forward operating base
<b>FPF</b>	final protection fires
<b>FRAGO</b>	fragmentary order
<b>FS</b>	fire support
<b>FSB</b>	forward support battalion
<b>FSCL</b>	fire support coordination line
<b>FSCOOD</b>	fire support coordinator
<b>FSE</b>	fire support element
<b>FSO</b>	fire support officer

**G**

<b>G1</b>	Assistant Chief of Staff (Personnel)
<b>G2</b>	Assistant Chief of Staff (Intelligence)
<b>G3</b>	Assistant Chief of Staff (Operations and Plans)
<b>G3-Air</b>	air operations and planning officer
<b>G4</b>	Assistant Chief of Staff (Logistics)
<b>GBU</b>	guided bomb unit
<b>GEMSS</b>	ground-emplaced mine scattering system
<b>GIRS</b>	grid index reference system
<b>GLD</b>	ground laser designator
<b>GLO</b>	ground liaison officer

<b>GPS</b>	global positioning system
<b>GS</b>	general support
<b>GSR</b>	ground surveillance radar

**H**

<b>HD</b>	heavy drop
<b>HDRS</b>	heavy drop rigging site
<b>HE</b>	high explosive
<b>HEAT</b>	high-explosive antitank
<b>HEX</b>	high-explosive incendiary
<b>HELLFIRE</b>	heliborne fire-and-forget missile
<b>HEMTT</b>	heavy expanded mobile tactical truck
<b>HEPI</b>	heavy equipment point of impact
<b>HET</b>	heavy equipment transporter
<b>HF</b>	high frequency
<b>HHB</b>	headquarters and headquarters battery
<b>HHC</b>	headquarters and headquarters company
<b>HMMWV</b>	high mobility multipurpose wheeled vehicle
<b>HQ</b>	headquarters
<b>HUMINT</b>	human intelligence
<b>HVT</b>	high-value target

**I**

<b>ICM</b>	improved capabilities missile
<b>ID</b>	identification
<b>IDAD</b>	internal defense and development
<b>IEW</b>	intelligence and electronic warfare
<b>IEWSE</b>	intelligence and electronic warfare support element



<b>IFF</b>	identification, friend or foe
<b>int</b>	intelligence
<b>INTREP</b>	intelligence report
<b>INTSUM</b>	intelligence summary
<b>IP</b>	initial point
<b>IPB</b>	intelligence preparation of the battlefield
<b>IR</b>	infrared
<b>IRC</b>	initial ready company
<b>ISB</b>	intermediate staging base

**J**

<b>JAAT</b>	joint air attack team
<b>JCS</b>	Joint Chiefs of Staff
<b>JFC</b>	joint force commander
<b>JSEAD</b>	joint suppression of enemy air defense
<b>JTF</b>	joint task force

**K**

<b>KE</b>	kinetic energy
<b>KIA</b>	killed in action
<b>km</b>	kilometers

**L**

<b>LAB</b>	light armor battalion
<b>LAC</b>	light armor company
<b>LACC</b>	loading area control center
<b>LADW</b>	local air defense warnings
<b>LANTIRN</b>	low-altitude navigation and targeting infrared for night
<b>LAP</b>	light armor platoon
<b>LAPES</b>	low altitude parachute extraction system

<b>LAW</b>	light antitank weapon
<b>LBE</b>	load-bearing equipment
<b>LC</b>	line of contact
<b>LD</b>	line of departure
<b>LD/LC</b>	line of departure is line of contact
<b>LEN</b>	large extension nodes
<b>LGB</b>	laser guided bomb
<b>LID</b>	light infantry division
<b>LO</b>	liaison officer
<b>LOA</b>	limit of advance
<b>LOC</b>	lines of communication
<b>log</b>	logistics
<b>LOGPAC</b>	logistics package
<b>LOGSTAT</b>	logistical status
<b>LOS</b>	line-of-sight
<b>LOS-R</b>	line-of-sight rear
<b>LP</b>	listening post
<b>LP/OP</b>	listening post/observation post
<b>LRF</b>	laser range finder
<b>LRP</b>	logistic release point
<b>LRSD</b>	long-range surveillance detachment
<b>LSA</b>	logistic support area
<b>LST</b>	laser spot tracker
<b>LTACFIRE</b>	light tactical fire direction system
<b>LTD</b>	laser target designator
<b>LVAD</b>	low-velocity air drop
<b>LZ</b>	landing zone

**M**

<b>MAC</b>	military airlift command
<b>MACG</b>	marshaling area control group

**MANPADS** man-portable air defense systems  
**MBA** main battle area  
**MCO** movement control officer  
**MCP** maintenance collection point  
**MCS** mobility, countermobility, and survivability  
**MCT** movement control team  
**MEDEVAC** medical evacuation  
**MEMO** mission-essential maintenance only  
**METT-T** mission, enemy, terrain, troops, and time available  
**MG** machine gun  
**MGB** medium girder bridge  
**MHE** materials handling equipment  
**MI** military intelligence  
**MIA** missing in action  
**MICLIC** mine clearing line charge  
**mm** millimeter(s)  
**MMC** materiel management company  
**MMEE** missing mission essential equipment  
**MOG** maximum-on-ground  
**MOPP** mission-oriented protection posture  
**MOS** military occupational specialty  
**MOUT** military operations on urbanized terrain  
**MP** military police  
**MPP** mobile pre-positioning  
**MRE** meals, ready to eat  
**MRS** muzzle reference system  
**MSB** main support battalion  
 mobile subscriber equipment

**MSR** main supply route  
**MSRT** mobile subscriber radio terminal  
**MST** maintenance support team  
**MTOE** modification table of organization and equipment  
**MTP** mission training plan

**N**

**NAI** named area(s) of interest  
**NBC** nuclear, biological, chemical  
**NBCWRS** NBC warning and reporting system  
**NC** node center  
**NCA** National Command Authority  
**NCO** noncommissioned officer  
**NCS** net control station  
**NEO** noncombatant evacuation operation  
**NET** new equipment training  
**NGF** naval gunfire  
**NGLO** naval gunfire liaison officer  
**NGO** naval gunfire officer  
**N-HOUR** notification hour  
**NOD** night observation device  
**NVD** night-vision device  
**NVG** night-vision goggles

**O**

**OAS** offensive air support  
**obj** objective  
**OCOKA** observation and fields of fire, cover and concealment, obstacles, key terrain, avenues of approach

<b>OI</b>	operations and intelligence
<b>OIC</b>	officer in charge
<b>OIR</b>	other intelligence requirements
<b>OP</b>	observation post
<b>OPCON</b>	operational control
<b>OPLAN</b>	operation plan
<b>OPORD</b>	operation order
<b>ops</b>	operations
<b>OPSEC</b>	operations security
<b>ORP</b>	objective rally point

## P

<b>P&amp;A</b>	personnel and administration
<b>PA</b>	physicians assistant
<b>PAC</b>	personnel and administrative center
<b>PADS</b>	position azimuth determining system
<b>PAO</b>	public affairs office
<b>PCO</b>	peacetime contingency operations
<b>PCI</b>	precombat inspection
<b>PEWS</b>	platoon early warning system
<b>PHA</b>	personnel holding area
<b>P-hour</b>	parachute hour
<b>PI</b>	point of impact
<b>Pi</b>	probability of incapacitation
<b>PIR</b>	priority intelligence requirements
<b>PKO</b>	peacekeeping operations
<b>PL</b>	phase line(s)
<b>PLL</b>	prescribed load list
<b>PMCS</b>	preventive maintenance checks and services
<b>POL</b>	petroleum, oils, and lubricants

<b>POM</b>	preparation for overseas movement
<b>POMCUS</b>	pre-positioning of materiel configured to unit sets
<b>POV</b>	privately owned vehicle
<b>POW</b>	prisoner of war
<b>PP</b>	passage point(s)
<b>PPI</b>	personnel point of impact
<b>PRF</b>	pulse radiation frequency
<b>PRI TGT</b>	priority target
<b>PRVEP</b>	prerigged vehicles/equipment package
<b>PSC</b>	personnel service company
<b>PSNCO</b>	personnel services NCO
<b>psn</b>	position (in illustration)
<b>PSO</b>	personnel services officer
<b>PSS</b>	personnel service support (in illustration)
<b>PSYOP</b>	psychological operations
<b>PVL</b>	priority vehicle list
<b>PW</b>	prisoner of war
<b>PX</b>	post exchange
<b>PZ</b>	pickup zone

## Q

<b>QSS</b>	quick supply store
------------	--------------------

## R

<b>RAOC</b>	rear area operations center
<b>RAP</b>	rocket-assisted projectile
<b>RATELO</b>	radiotelephone operator
<b>RATT</b>	radio teletypewriter
<b>RAU</b>	radio access unit
<b>RC</b>	reserve component

<b>RCU</b>	remote control unit
<b>REDCON</b>	readiness condition
<b>REMBASS</b>	remotely monitored battlefield sensor system
<b>REMS</b>	remotely employed sensor
<b>retrans</b>	retransmit
<b>RFL</b>	restrictive fire line
<b>ROE</b>	rules of engagement
<b>RP</b>	release point
<b>RPG</b>	rocket-propelled grenade
<b>R&amp;S</b>	reconnaissance and surveillance
<b>RSOP</b>	readiness standing operating procedure
<b>RSR</b>	required supply rate
<b>RTO</b>	radiotelephone operator
<b>RX</b>	repairable exchange

**S**

<b>2IC</b>	second in command
<b>S&amp;S</b>	supply and service
<b>S&amp;T</b>	supply and transport
<b>S1</b>	adjutant
<b>S2</b>	intelligence officer
<b>S3</b>	operations and training officer
<b>S3-Air</b>	assistant battalion S3 (air operations)
<b>S4</b>	supply officer
<b>SAFAD</b>	small arms for air defense
<b>SALT</b>	supporting arms liaison team
<b>SALT-Air</b>	supporting arms liaison team S3 (air operations)
<b>SAM</b>	surface-to-air missile
<b>SATCOM</b>	satellite communications
<b>SAW</b>	squad automatic weapon

<b>SEAD</b>	suppression of enemy air defense
<b>SEE</b>	small emplacement excavator
<b>SEN</b>	small extension nodes
<b>SHELREP</b>	shelling report
<b>SHORAD</b>	short-range air defense
<b>SINCGARS</b>	single channel ground and airborne subsystem
<b>SITREP</b>	situation report
<b>SKE</b>	station keeping equipment
<b>SO</b>	signal officer
<b>SOC</b>	special operations command
<b>SOF</b>	special operating force
<b>SOI</b>	signal operating instructions
<b>SOP</b>	standing operating procedure
<b>SP</b>	start point
<b>SR</b>	supply rate
<b>S&amp;S</b>	supply and service
<b>S&amp;T</b>	supply and transportation
<b>STANAG</b>	standardization agreement
<b>SVML</b>	standard vehicle missile launcher

**T**

<b>TA</b>	tactical airlift
<b>TAC</b>	Tactical Air Command
<b>TAC-A</b>	tactical air controller
<b>TACAIR</b>	tactical air support
<b>TAC CP</b>	tactical command post
<b>TACFIRE</b>	tactical fire direction system
<b>TACP</b>	tactical air control party
<b>TACSAT</b>	tactical satellite
<b>TAI</b>	target area(s) of interest
<b>TAMMS</b>	The Army maintenance management system

<b>TAR</b>	tactical air reconnaissance
<b>TC</b>	tank commander
<b>TDAR</b>	tactical display alerting radar
<b>TDIS</b>	time distance
<b>TEWT</b>	tactical exercise without troops
<b>TF</b>	task force
<b>TIRS</b>	terrain index reference system
<b>TLP</b>	troop leading procedures
<b>TOC</b>	tactical operations center
<b>TOE</b>	table(s) of organization and equipment
<b>TOT</b>	time on target
<b>TOW</b>	tube-launched, optically tracked, wire-guided
<b>TPU</b>	tank and pump unit
<b>TRADOC</b>	United States Army Training and Doctrine Command
<b>TRP</b>	target reference point
<b>TSOP</b>	tactical SOP
<b>TTS</b>	tank thermal sight
<b>TV</b>	television
<b>TVA</b>	target-value analysis

**U**

<b>UH</b>	utility helicopter
<b>UHF</b>	ultrahigh frequency
<b>UMCP</b>	unit maintenance collection point
<b>US</b>	United States (of America)
<b>USAF</b>	United States Air Force
<b>USMC</b>	United States Marine Corps
<b>USN</b>	United States Navy
<b>UXO</b>	unexploded ordnance

**V**

<b>VHF</b>	very high frequency
<b>Vinson</b>	(an encryption device)
<b>vis</b>	visibility
<b>volcano</b>	(a scatterable mine system)

**W**

<b>WAM</b>	wide-area mine
<b>WIA</b>	wounded in action
<b>WO</b>	warning order
<b>WOC</b>	wing operations center
<b>WP</b>	white phosphorus
<b>WSRO</b>	weapons system replacement operations

**X**

<b>XO</b>	executive officer
-----------	-------------------

## REFERENCES

## SOURCES USED

These are the sources quoted or paraphrased in this publication.

### Joint and Multiservice Publications

- FMFM 6-18** Techniques and Procedures for Fire Support Coordination. 27 March 1992.
- FMFRP 1-11** Fleet Marine Force Organization. 2 March 1992.

### Army Publications

- CMH Pub 90-17** Vietnam Studies: Mounted Combat in Vietnam. 1978.
- FM 1-112** Tactics, Techniques, and Procedures for the Attack Helicopter Battalion. 21 February 1991.
- FM 1-116** Air Cavalry/Reconnaissance Troop. 20 February 1991.
- FM 6-20-50** Tactics, Techniques, and Procedures for Fire Support and Brigade Operations (Light). 5 January 1990.
- FM 7-8** Infantry Rifle Platoon/Squad. 22 April 1992.
- FM 7-10** Infantry Rifle Company. 14 December 1990.

- FM 7-20** The Infantry Battalion. 6 April 1992.
- FM 7-30** The Infantry, Airborne, and Air Assault Brigade Operations. 19 September 1991.
- FM 7-90** Tactical Employment of Mortars. 11 June 1985.
- FM 7-98** Operations in Low Intensity Conflict. 19 October 1992.
- FM 17-15** Tank Platoon. 7 October 1987.
- EM 34-130** Intelligence Preparation of the Battlefield. 23 May 1989.
- FM 55-9** Unit Air Movement Planning. 31 August 1981.
- FM 55-450-3** Multiservice Helicopter External Air Transport. Volume I. February 1991.
- FM 55-450-4** Multiservice Helicopter External Air Transport. Volume II.
- FM 71-1** The Tank and Mechanized Infantry Company Team. 22 November 1988.
- FM 71-2** The Tank and Mechanized Infantry Battalion/Task Force. September 1988.
- FM 90-10** Military Operations in Urban Terrain. 15 August 1979.
- FM 100-5** Operations. 28 June 1993.

## FM 17-18

- FM 100-27** USA/USAF Doctrine for Joint Airborne and Tactical Airlift Operations. AFM 2-50.  
31 January 1985.
- FM 101-5** Staff Organization and Operations.  
25 May 1989.
- FM 101-5-1** Operational Terms and Symbols.  
21 October 1985.

### READINGS RECOMMENDED

These readings contain relevant supplemental information.

#### Joint and Multiservice Publications

- FM 20-15** National Search and Rescue Manual. AFM 64-2; COMDTINST M-161302.  
1 Nov 1986.
- STANAG 2014** Operation Orders, Warning Orders, and Administrative/Logistics Orders.
- STANAG 2029** Method of Describing Ground Locations, Areas, and Boundaries.  
1 December 1986.
- STANAG 2099** Fire Coordination in Support of Land Forces.  
4 November 1987.
- STANAG 2128** Medical and Dental Supply Procedures.
- STANAG 2144** Call for Fire Procedures.
- STANAG 2147** Target Numbering System (Non-nuclear).

- STANAG 3466/ASCC 44/13G** Responsibilities of Air Transport Units and Use Units in the Loading and Unloading of Transport Aircraft in Tactical Air Transport Operations. Edition 2.  
5 June 1975.
- STANAG 3570/ASCC 44/13G** Drop Zones and Extraction Zones-Criteria and Markings.  
26 March 1986.

#### Army Publications

- DA Form 581** Request for Issue and Turn-in of Ammunition.  
August 1989.
- DA Form 1155** Witness Statement on Individual.  
June 1966.
- DA Form 1156** Casualty Feeder Report.  
June 1966.
- DA Form 1594** Daily Staff Journal or Duty Officer's Log.  
November 1962.
- DA Form 2028** Recommended Changes to Publications and Blank Forms.  
February 1974.
- DA Form 2404** Equipment Inspection and Maintenance Worksheet.  
April 1979.
- DA Form 2765** Request for Issue or Turn-in.  
April 1976.
- DA Form 2765-1** Request for Issue or Turn-in.  
April 1976.
- DA Form 5368-R** Quick Fire Plan (LRA).  
December 1984.
- DD Form 1380** US Field Medical Card.  
June 1962.

<b>FM 3-50</b>	Deliberate Smoke Operations. 25 July 84.	<b>FM 17-95</b>	Cavalry Operations. 19 September 1991.
<b>FM 5-33</b>	Terrain Analysis. 11 July 1990.	<b>FM 17-98</b>	The Scout Platoon. 7 October 1987.
<b>FM 5-36</b>	Route Reconnaissance and Classification. 10 May 1985.	<b>FM 19-40</b>	Enemy Prisoners of War, Civilian Internees, and Detained Persons. 27 February 1976.
<b>FM 5-100</b>	Engineer Combat Operations. 22 November 1988.	<b>FM 20-32</b>	Mine/Countermine Operations. 30 September 1992.
<b>FM 5-101</b>	Mobility. 23 January 1985.	<b>FM 21-76</b>	Survival. 5 June 1992.
<b>FM 5-102</b>	Countermobility. 18 March 1985.	<b>FM 26-2</b>	Management of Stress in Army Operations. 29 August 1986.
<b>FM 5-103</b>	Survivability. 10 June 1985.	<b>FM 31-20</b>	Doctrine for Special Forces Operations. 20 April 1990.
<b>FM 5-114</b>	Engineer Operations Short of War. 13 July 1992.	<b>FM 31-70</b>	Basic Cold Weather Manual. 12 April 1968.
<b>FM 5-250</b>	Explosives and Demolitions. 15 June 1992.	<b>FM 33-1</b>	Psychological Operations. 31 July 1987.
<b>FM 6-20</b>	Fire Support in the AirLand Battle. May 1988.	<b>FM 41-10</b>	Civil Affairs Operations. 17 December 1985.
<b>FM 8-42</b>	Medical Operations in Low Intensity Conflict. 19 October 1992.	<b>FM 44-1</b>	US Army Air Defense Artillery Employment. 9 May 1983.
<b>FM 8-55</b>	Planning for Health support. 15 February 1985.	<b>FM 44-10</b>	US Army Air Defense Operations. 22 November 1988.
<b>FM 10-400</b>	Quartermaster Airdrop and Airdrop Equipment Support Units. 2 November 1984.	<b>FM 57-38</b>	Pathfinder Operations. 9 October 1968.
<b>FM 12-6</b>	Personnel Doctrine. 23 August 1989.	<b>FM 63-2-1</b>	Division Support Command: Light Infantry, Airborne, and Air Assault Divisions. 16 November 1992.
<b>FM 14-7</b>	Finance Operations. 9 October 1989.	<b>FM 71-3</b>	The Armored and Mechanized Infantry Brigade. 11 May 1988.
<b>FM 16-1</b>	Religious Support Doctrine: The Chaplain and Chaplain Assistant. 27 November 1989.	<b>FM 71-100</b>	Division Operations. 16 June 1990.



## FM 17-18

<b>FM 71-100-2</b>	Infantry Division Operations. To be published.	<b>FM 100-25</b>	Doctrine for Army Special Operations Forces. 12 December 1991.
<b>FM 71-123</b>	Tactics for Combined Arms Heavy Forces. 30 September 1992.	<b>FM 100-37</b>	Terrorism Counteraction. 24 July 1987.
<b>FM 90-2</b>	Battlefield Deception. 3 October 1988.	<b>FM 101-10/1</b>	Staff Officers Field Manual: Organizational Technical and Logistical Data (Volume I). 7 October 1987.
<b>FM 90-3</b>	Desert Operations. 24 August 1993.	<b>FM 101-10-2</b>	Staff Officers Field Manual: Planning Factors (Volume II). 7 October 1987.
<b>FM 90-4</b>	Air Assault Operations. 16 March 1987.		
<b>FM 90-5</b>	Jungle Operations. 16 August 1982.		
<b>FM 90-6</b>	Mountain Operations. 30 June 1980.		
<b>FM 90-8</b>	Counter guerrilla Operations. 29 August 1986.		
<b>FM 90-10-1</b>	An Infantryman's Guide to Combat in Built-Up Areas. 30 September 1982.		
<b>FM 90-13</b>	River Crossing Operations. 30 September 1992.		
<b>FM 90-13-1</b>	Combined Arms Breaching Operations. 28 February 1991.		
<b>FM 90-14</b>	Rear Battle. 10 June 1985.		
<b>FM 90-22</b>	Multiservice Procedures for Night and Adverse Weather Combat Operations. 31 January 1991.		
<b>FM 90-26</b>	Airborne Operations. 18 December 1990.		
<b>FM 100-10</b>	Combat Service support. 18 February 1988.		
<b>FM 100-15</b>	Corps Operations. 13 September 1989.		
<b>FM 100-20</b>	Low Intensity Conflict. 16 January 1981.		

## INDEX

- action drill, 4-27
- actions on contact, 4-23, 4-26, 4-47, 5-18
- administrative/logistics (A/L) net, 6-6, 6-8 and 6-9 (Figure 6-5), 8-12 and 8-13, 8-30
- advance guard, 4-44 and 4-45, 6-12 and 6-13
- air and naval gunfire liaison company (ANGLICO), 1-14, 3-6
- air assault
  - battalion, 4-3
  - brigade, 5-3
  - division, B-3, D-1 thru D-5
- air defense, 1-14, 1-16, 2-23, 4-6, 5-7, 6-5, 6-8, 7-34, 7-36, A-3, A-5, B-2, B-5, C-1 thru C-4, D-3
- air defense artillery (ADA), 2-8, 2-23, 3-13, 4-6, 6-6, 6-13, 6-21, 6-23, 7-2, 7-34 and 7-35, 8-21, A-3, A-5, C-3 and C-4, D-3
- air defense warnings, 7-36
- air support, 1-13, 5-7, 7-23 thru 7-36, A-1 thru A-12, D-1 thru D-5
- airborne
  - armor, 1-4 and 1-5
  - battalion, 4-3
  - brigade, 5-3
  - division, A-3, C-1 thru C-4
- airdrop, 8-3, 8-5, 8-7, A-3 and A-4, A-10, C-1 thru C-4
- airlift operations, 3-9 and 3-10, A-1 thru A-12
- airland operations, 1-2, 3-8, 3-12, A-1 thru A-5, C-2 and C-3
- ambulance squads, 8-36
- ambush fires (engagement technique), 4-18
- ambush in defense in sector, 4-66
- ambush points, 2-15
- ammunition transfer point (ATP), 8-15
- analysis using factors of METT-T
  - terrain, 2-11 and 2-12
  - threat, 2-13 and 2-14
  - weather, 2-13
- antiarmor
  - battalion, 1-8, 4-3
  - systems, B-1
  - weapons, 1-8, 4-47 and 4-48, 5-4, 5-7, 5-14
- antiterrorism operations, 1-6
- approach march technique, 4-44
- arctic terrain, 4-61
- armored forces (heavy), 1-4 and 1-5
- artillery. See air defense artillery (ADA); field artillery
- assault
  - echelon, 3-2
  - fire, 4-18
  - force, 3-10 thru 3-12, 4-25, 4-39
  - troops, A-4
- assembly areas, 2-20, 4-70, 4-83, 6-20, 6-25 and 6-26, 6-28, 8-11, 8-24 and 8-25, A-4 and A-5
- attack
  - by fire, 4-25, 5-5
  - by infiltration, 4-41 and 4-42
  - deliberate, 4-40, 5-5, 5-19, 6-14 and 6-15
  - from a defensive posture, 6-20
  - frontal, 4-44
  - hasty, 4-48 and 4-49, 5-5, 5-17 and 5-18, 6-13 and 6-14
  - helicopter mission, 6-22, 7-33, A-4, D-2 thru D-4

**attack (cont)**

- in built-up areas, 4-49 thru 4-56
- main, 4-43
- methods of, 4-47 and 4-48
- night, 4-60, 5-6, 5-24
- of a strongpoint, 4-71
- position, 4-83, 6-20
- raid, 4-58
- spoiling, 6-20
- supporting, 4-86
- types of, 4-48 and 4-49
- attack an objective drill, 4-36
- attack helicopter support, 7-31 thru 7-33, 8-8
- augmentation, 3-6, 3-8, 4-4, 5-3, 8-2 and 8-3
- Avenger, 1-14, 6-23, 7-39, B-2, C-3, D-3
- avenues of approach, 2-11 thru 2-15, 5-25, 5-27, 5-29, 5-34, 6-12, 6-21 and 6-22, 8-13, A-1
- aviation
  - air assault division, D-1 thru D-5
  - airborne division, C-1 thru C-4
  - airlift operations, A-1 thru A-12
  - Army aviation support, 7-32 and 7-33
  - tactical air, 7-23 thru 7-32. See also tactical air support
- axes of advance, 6-12, 6-16, 7-40
- backbriefs, 2-19
- backward planning, 2-4 and 2-5 (Figure 2-2)
- battalion
  - formations, 6-10 and 6-11
  - functions, 6-1, 6-6
  - headquarters and headquarters company, 6-3
  - maneuver, 6-5
  - missions, 6-4

- organization, 6-2
- radio nets, 6-8 and 6-9
- scout and mortar platoons, 6-3
- security area operations, 6-22
- battalion aid station (BAS), 8-36
- battle damage assessment and repair (BDAR), 3-13, 8-9, 8-28
- battle drills, 1-10, 4-25 thru 4-37
- battle handover, 6-25
- battle positions
  - company, 5-27
  - defense of, 4-65
  - light armor battalion, 2-4, 2-7, 4-78, 6-17 thru 6-19
  - platoon, 4-65 thru 4-73
- battlefield area evaluation, 2-10 and 2-11
- battlefield operating systems (BOS), 1-15
  - air defense, 1-14, 5-7, B-2 and B-3, C-3, D-3
  - combat service support, 1-14 and 1-15, 5-9, B-2 and B-3, C-3, D-3
  - command and control 1-15, 5-8, B-3, C-3, D-2 and D-3
  - fire support, 1-13, 5-7, B-2, C-2, D-2 and D-3
  - intelligence, 1-16, 5-6, B-1, C-1 and C-2, D-2
  - maneuver, 1-16, 5-6, B-2, C-2, D-2
  - mobility, countermobility, and survivability, 1-14, 4-6, 5-7, 6-5, 7-37 thru 7-40, B-2, C-2, D-3
- booby traps, 2-14
- breach force, 4-39, 5-22
- breaching operations, 4-39 and 4-40, 5-22 and 5-23, 6-14
- break contact drill, 4-35
- breakout from encirclement, 4-85 and 4-86, 5-6
- briefbacks, 2-18

- brigade
  - assault force, 3-13
  - reserve, 5-5
- bypass, 4-58
- camouflage, 2-13, 2-23
- casualty evacuation, 8-35 and 8-36, C-4
- change of formation drill, 4-27
- chaplain. See religious support
- civil affairs. See host-nation support
- classes of supply, 1-8, 3-11, 8-5 thru 8-7, 8-14 thru 8-16
- clothing exchange and bath (CEB), 8-33
- close air support, 1-12, 6-20, 7-23 thru 7-31, A-1, C-1 and C-2, D-2 and D-3
- cloverleaf search technique, 5-16 (Figure 5-11)
- combat operations
  - build-up, 3-12 thru 3-14 (Figure 3-5)
  - decisive, 3-3, 3-14 (Figure 3-6)
- combat service support
  - airdrop, A-3, A-10
  - airland, A-1 thru A-5
  - clothing exchange and bath, 8-33
  - contingency techniques of, 8-1 thru 8-11
  - enemy prisoners of war (EPW), 5-23, 8-34
  - field services, 8-32
  - finance, 8-34
  - health service support, 8-35
  - legal service support, 8-34
  - maintenance, 3-11, 8-8 and 8-9
  - maintenance techniques, 8-27 thru 8-32
  - medical, 8-35 thru 8-37
  - mortuary affairs, 8-32
  - personnel services, 8-33
  - postal service support, 8-34
  - procedures for, 5-8
  - religious support, 8-34
  - salvage services, 8-33
  - security, 8-13
  - supply and resupply techniques, 8-14 thru 8-27
  - supply considerations, 3-5 thru 3-7
  - trains, 8-11 thru 8-13
- combat support
  - air defense support. See air support
  - Army aviation support, 7-32 and 7-33
  - engineer support, 7-37 thru 7-39
  - fire support, 7-2 thru 7-22
  - mortars, 7-16 thru 7-19
  - naval gunfire, 7-20 thru 7-22
  - nuclear, biological, and chemical support, 7-41 thru 7-42
  - tactical air support, 7-23 thru 7-31
- combat trains, 6-6, 8-11 and 8-12
- combined arms team, 1-8, 1-11, 3-5, 6-22, D-1
- command and control. See also C3
  - company, 5-8 and 5-9
  - light armor platoon, 4-7
  - procedures, 2-26
  - techniques, 1-10, 2-18 thru 2-22, 4-95
- command, control, and communications (C3), 2-1
  - abbreviated planning, 2-8
  - checklist, 2-7 and 2-8
  - command estimate, 2-5 thru 2-7
  - continuous operations, 2-24, 8-13
  - hasty estimate, 2-8 (Figure 2-4) and 2-9
  - intelligence preparation of the battlefield (IPB), 2-2, 2-9 thru 2-15
  - leadership, 2-2 thru 2-5
  - light armor battalion, 6-12 thru 6-17
  - light armor company, 5-8 thru 5-13

- command, control, and communications (C3) (cont)
  - light armor platoon, 4-7 thru 4-17
  - OPSEC, 2-22
  - planning process, 2-2
  - techniques of, 2-18 thru 2-22, 4-95
  - troop-leading procedures, 2-2 thru 2-5
- command group, 6-5, 6-27
- command net, 4-7, 5-9, 5-10, 6-8
- command post
  - exercise, 2-19
  - main, 3-11, 6-6, 6-8, 8-12, 8-21
  - procedures, 6-7 thru 6-9
  - tactical, 2-26, 3-11, 6-5 and 6-6, A-3, B-3
- communications, 2-16 and 2-17
  - electronics, 8-31
  - messengers, 4-8, 5-9
  - mobile subscriber equipment, 2-16 and 2-17
  - nets, 5-9 and 5-10 (Figure 5-2), 6-8, 6-23, 6-28
  - radio, 2-13, 4-9, 5-10, 6-8, 6-23, 6-28, B-3, D-3 and D-4
  - responsibilities, 2-16
  - security, 5-10, 8-30, 8-33
  - sound, 5-9, 4-9
  - tactical, 4-8 and 4-9
  - visual, 5-9, 4-8
  - wire, 5-11, 4-8
- company maintenance team (CMT), 8-12, 8-27 thru 8-31
- company trains, 8-11 thru 8-13
- concealment, 2-23. See also cover and concealment
- concentration of fires, 1-13
- conflict, 1-3 and 1-4
- consolidation and reorganization, 4-59 and 4-60, 5-23
- contact drill, 4-27
- Continental United States (CONUS), 1-1, 3-3 and 3-4, 3-11
- contingency operations (CONOPS), 1-1 thru 1-3, 3-1 thru 3-14, 8-1 and 8-2, 8-4, 8-10 and 8-11, 8-33, D-3
  - deployment, 3-11, C-1
  - force projection, 3-7
  - fundamentals of, 3-1 thru 3-5
  - light armor employment, 3-5
  - operations other than war, 3-3 thru 3-4
  - phases of, 3-7 thru 3-14
  - postconflict operations, 3-14
  - predeployment activity, 3-14
  - preparation and planning for, 3-7 thru 3-9
  - redeployment and reconstitution, 3-14
  - support considerations, 3-5 thru 3-7
- continuous operations
  - effects of, 2-24 and 2-25
  - leader sustainment, 2-25
  - sleep loss recovery, 2-26
  - sleep plans, 2-27
  - sleep priorities, 2-25
  - unit sustainment, 2-26
- control measures, 4-57, 6-25
- controlled exchange, 8-16
- controlled supply rate (CSR), 8-15
- convoy security, 4-80 thru 4-82, 5-37, 8-22
- coordination, 1-1, 2-4
- Copperhead, 6-22
- corps support command (COSCOM), 8-11, 8-15 thru 8-17
- counterair support, 7-23
- counterattack, 6-20
  - by fire, 4-75, 5-33
  - by fire and maneuver, 4-75, 5-33
  - force, 4-74 and 4-75, 5-5

- counterdrug operations, 3-3
- counterguerrilla operations, 1-5 and 1-6, 2-11 thru 2-13
- counterinsurgency, 1-2, 1-5, 2-11, 2-13
- countermobility, 1-14, 7-40. See also mobility and survivability
- countersurveillance, 2-22 and 2-23
- counterreconnaissance, 1-13, 2-23, 6-21 thru 6-24
- counterterrorism operations, 1-6
- cover (mission), 1-13, 5-5
- cover and concealment, 2-15, 2-23, 4-33, 4-67, 6-16
  
- danger areas, 4-37 thru 4-40
- deception, 2-23, 4-65, 5-6 and 5-7, 6-28
- decision-making process, 2-2, 2-4, 2-6
- decisive combat operations, 3-16
- decisive points, D-5
- decontamination, D-4
- defensive operations
  - against air attacks, 4-33, 7-23, 7-29, 7-36
  - against infiltration, 4-73, 5-32
  - antiarmor, 5-30 and 5-31
  - area, 5-7, 5-25
  - battle positions, 6-19
  - counterreconnaissance, 1-15, 2-23
  - fundamentals, 1-11
  - in built-up areas, 4-72 thru 4-74, 5-31 and 5-32
  - in sector, 4-66 and 4-67, 5-6, 5-34, 6-18
  - linear, 4-33
  - mobile, 5-25
  - of a light armor battalion, 6-17 thru 6-20
  - of a light armor company, 5-24 thru 5-34
  - of a light armor platoon, 4-62 thru 4-76
  - of a strongpoint, 4-71 and 4-72, 5-28
  - of or from a battle position, 4-65, 5-27, 6-19
  - other defensive tasks, 5-32 and 5-33, 6-20
  - perimeter, 4-70, 5-29
  - preparation for, 4-63 thru 4-65
  - purpose of, 1-10
  - reserve force, 4-74, 6-20
  - reverse slope, 4-67
  - security of, 4-63
- delay, 1-11 and 1-12, 4-77 and 4-78, 5-6, 5-35, 6-20
- deliberate attack, 4-49, 5-5, 5-18 and 5-19, 6-14, 6-20 and 6-21
- deliberate breach, 1-9. See breaching operations
- demolitions, 7-40
- demonstrations (and shows of force), 1-6, 2-13, 3-3, 3-7
- deployment
  - in contingency operations, 3-12 thru 3-15, D-1
  - in depth, 3-3, 3-16
  - rapid, 1-2, 3-5, 3-9, C-1
- desert terrain, 4-61
- detachment, 1-8, 6-20
- direct fire control, 4-15
- direct fire planning, 4-17, 4-62 and 4-63, 4-71, 4-73, 5-26
- direct support (DS), 8-7, 8-21, 8-28, 8-34, A-3
- disaster relief, 3-1, 3-3
- division support area (DSA), 8-15 and 8-16
- division support command (DISCOM), 3-11, 8-3, 8-5, 8-15
- double envelopment, 4-44
- drills. See battle drills
- drop zone (DZ), 3-8

- electronic warfare (EW), 1-13
- emergency relief, 1-4
- employment
  - company, 5-4 and 5-5, 5-14
  - light armor battalion, 6-4 thru 6-5
  - light armor company, 5-4 thru 5-8
  - light armor fundamentals, 1-9
  - light armor platoon, 4-2 thru 4-7
- enemy. See threat
- engagement area, 1-9, 1-14, 2-8, 4-65, 4-71 and 4-72, 5-27 and 5-28, 5-30, 6-20, 6-23, 7-24
- engagement techniques, 4-18
- engineer support, 5-7, 7-37 thru 7-39
- entry operations
  - opposed (forced), 3-11, 4-76, C-1
  - unopposed, 4-77, A-1
- envelopment, 4-43 and 4-44
- estimate of the situation. See command estimate
- evacuation
  - medical, 8-36
  - noncombatant, 8-36
- exploitation, 1-9, 5-5, 5-20, 6-15
  
- family of scatterable mines (FASCAM), 1-7, 1-12
- feint, 4-55, 4-77
- field artillery, 1-13, 6-8, 6-22 and 6-23, 7-2, 7-13 thru 7-15, A-4, C-4, D-3
- field services, 8-32 and 8-33
- field trains. See trains, field
- fields of fire, 2-11, 2-13, 4-64, 5-4, 5-32
- fields of observation, 6-23
- fighting positions, 4-64
- final protective fires, 4-64
- finance support, 8-34
  
- fire and maneuver, 4-24 and 4-25, 4-75, 5-33
- fire control, 4-15 thru 4-17
- fire patterns, 4-16
- fire planning, 4-17, 8-13
- fire support, 1-14, 3-2, 3-4, 3-12 and 3-13, 4-6, 4-84, 5-7, 6-5, 6-26, 6-28, 7-2 thru 7-23, B-3, C-2, D-2 and D-3
- fire support element (FSE), 1-14, 6-5, 6-8
- fire support officer (FSO), 2-13, 6-5, 6-8, 6-22
- fire support planning, 7-13
- fire support team (FIST), 2-4, 6-5, 6-8
- fires
  - alternating, 4-17
  - cross, 4-16
  - depth, 4-16
  - frontal, 4-16
  - observed, 4-17
  - simultaneous, 4-17
- flank guard, 4-44, 5-22, 6-12 and 6-13, 6-16
- follow and support, 5-5
- follow-on forces, 3-2, 3-11 thru 3-13, 8-10, C-2
- forced entry. See entry, opposed
- force(s). See also irregular forces
  - counterattack, 4-74 and 4-75, 5-33
  - deployment of, 3-12, C-4
  - direct pressure, 5-20
  - encircling, 5-20
  - enemy, 3-6, 3-11 thru 3-14, 4-4
  - follow and support, 5-20
  - heavy, 2-2, B-1, B-4
  - projection, 3-7 thru 3-14
  - reserve, 4-74
  - security, 1-2, 4-68, A-4 and A-5
- forest terrain, 4-61

- formations. See also movement formations
- light armor company, 5-10 thru 5-13
  - light armor platoon, 4-9 thru 4-15
- forms of maneuver, 4-41 thru 4-44. See also maneuver
- forward air controller (FAC), 6-5, 6-8, 7-10, 7-26, A-3
- forward passage of lines, 2-18, 4-83 and 4-84
- fratricide, 4-52, 4-83, 5-24, E-1 thru E-9
- frontal attack, 4-44
- frontal fire, 4-16
- general support (GS), 8-28, 8-34
- guard operations, 1-9, 1-12, 6-4
- guerrilla operations, 2-12 thru 2-14
- hand-and-arm signals, 2-23, 4-8, 5-8
- hasty attack, 1-9, 4-48 and 4-49, 5-5, 5-17 and 5-18, 6-3, 6-13
- headquarters and headquarters company, 6-2, 8-3, 8-12, 8-19, 8-21 and 8-22, 8-30, 8-32 and 8-33
- health services support, 8-35
- helicopters. See attack, helicopter mission
- hit-and-run tactics, 1-6, 2-14
- high-value target(s) (HVT), 2-15, 3-4, 6-5
- host nation, 1-6, 2-10 and 2-11, 3-13
  - civil affairs, 2-10 and 2-13, 3-4, 8-28
  - population, 2-10, 2-13
- humanitarian assistance, 3-1
- indirect fire support, 1-10 1-17, 2-14 and 2-15, 3-13, 4-24, 4-25, 4-39, 5-23, 5-30, 6-8, 6-26, 7-2 thru 7-22
  - infantry mounted, 4-21
  - M8 mounted, 4-22 and 4-23
  - truck mounted, 4-22
- infiltration, 4-41 and 4-42
- information security, 2-24
- in-stride breach. See breaching operations
- insurgency, 1-2, 1-5, 2-11 thru 2-15
- intelligence and electronic warfare (IEW), 1-13, 2-10
- intelligence preparation of the battlefield (IPB), 2-2 and 2-5 (Figure 2-1), 2-7 thru 2-15, 6-21 and 6-22, D-2
- intermediate staging base (ISB), 3-11, 3-14 (Figure 3-4), 8-4, C-3
- irregular forces, 1-8
  - guerrilla, 2-14
  - insurgency, 2-4
  - terrorism, 1-2, 1-4 and 1-5, 1-7
- jamming, 2-23, D-2
- joint air attack team (JAAT), 7-29
- Joints Chiefs of Staff (JCS), 3-9
- jungle terrain, 2-12, 4-61
- key terrain, 2-11 and 2-12, 4-41 thru 4-43, 4-65, 4-70
- killed in action (KIA), 8-20, 8-24 and 8-25
- landmines. See mines
- leadership, 1-11, 2-2
- legal services support, 8-34
- liaison officer, 2-2, 5-10
- light armor
  - battalion, 3-8, 6-1 thru 6-28, 8-3, 8-8, 8-11
  - capabilities and limitations, 1-9, B-3 and B-4
  - company, 1-9, 5-1 thru 5-37, 6-3, 6-18, 8-1
  - employment, 1-4 and 1-5, 1-10, 3-2, 3-5, 5-4
  - missions, 1-2, 3-3 thru 3-7, 4-4, 5-5
  - platoon, 1-9, 4-1 thru 4-87, 8-1



- light armor (cont)**
  - role of, 1-1 thru 1-6
  - units, 1-2, 1-5, 1-13, 3-1 thru 3-7, 6-1, 6-19, 8-1, A-6, C-4
- light/heavy integration, operations, 1-9 thru 1-11
- light infantry
  - battalion, 4-3, 8-1, B-1
  - battalion attacks, 4-40 thru 4-44
  - brigade, 5-3, B-1
  - division, 1-1, 1-12 thru 1-14, 2-17, 3-2, 6-17, 6-20, 8-22, B-1 thru B-4
  - M8 mounted, 4-22 and 4-23
  - missions (when operating with a brigade), 1-13, 5-5 and 5-6
  - movement techniques, 4-19 thru 4-21
  - truck mounted, 4-22
- limited visibility, 4-60 thru 4-62, 4-75, 4-86, 5-24, 5-34, 6-28
- line of departure, 2-7, 2-20, 6-20
- linkup operations, 4-84, 5-6
- lodgement
  - area, 3-10 thru 3-14, 4-76, 5-34, D-1
  - seizure of, 3-2, 3-12 and 3-13, 4-76 and 4-77, 8-2 and 8-3
- logistics, 1-10, 7-42, 8-13 and 8-14
- LOGPAC operations, 2-18, 8-19 thru 8-25
- M8 light tank
  - capabilities/specifications, 1-2, 1-8, 1-12
  - employment considerations, 4-56
- main attack, 4-43
- main battle area, 5-25, 6-23 and 6-24, 7-34
- main body, 1-13, 2-7, 3-12, 4-44, 4-46, 4-58, 4-77 thru 4-79 and 4-79, 4-86, 5-22, 5-36 and 5-37, 6-12 and 6-13
- main supply route (MSR), 1-12, 8-12, 8-20, 8-27, 8-34
- maintenance collection point (MCP), 8-31
- maintenance techniques, 8-27 thru 8-32
- maneuver, 1-13, 4-41 thru 4-44, B-2, D-2
- masking (of fires), 4-48
- medical
  - company, 8-35
  - evacuation, 8-4, 8-12, 8-23, 8-35 and 8-36
  - platoon, 8-35
  - supply, 2-12, 8-37
- military operations in urban terrain (MOUT). See operations in built-up areas
- mines, 2-14, 4-81, B-2
- mission, enemy, terrain, troops, and time available (METT-T), 1-4, 1-10, 2-2 thru 2-6 (Figure 2-1), 2-11 and 2-12, 3-5, 3-10 and 3-11, 5-25, 6-5, 6-10, 6-18, 8-11, 8-18, B-1 and B-2
- missions, 4-83, 5-5, 6-4, 7-24 thru 7-27
- mobile subscriber equipment (MSE), 2-16 and 2-17, 8-13
- mobility, 2-14, 3-7, 7-40. See also mobility and survivability
- mobility and survivability, 1-14, 2-14, 4-6, 5-7, 6-5, B-2, D-3
- mortars, 7-16 thru 7-19
- mortuary affairs, 3-11, 8-32
- mountain terrain, 2-12, 4-61
- mounted infantry. See infantry, M8 mounted
- movement
  - dismounted, 4-21
  - M8 mounted, 4-22 and 4-23
  - mounted, 4-18 and 4-19
  - truck mounted, 4-22
- movement formations (light armor battalion). See also formations
  - column, 6-10
  - wedge, 6-11
  - vee, 6-11
- movement formations (light armor company). See also formations
  - column, 5-10

- movement formations (light armor company). See also formations (cont).
  - echelon, 5-13
  - line, 5-13
  - modified wedge, 5-12
  - wedge, 5-10 and 5-11
  - vee, 5-13
- movement formations (light armor platoon). See also formations
  - coil, 4-14
  - column/staggered column, 4-13
  - echelon, 4-12
  - herringbone, 4-14 and 4-15
  - line, 4-12 and 4-13
  - vee, 4-11
  - wedge, 4-10
- movement techniques
  - bounding overwatch, 4-21
  - light infantry, 4-19 thru 4-21
  - tactical, 5-14
  - traveling, 4-20
  - traveling overwatch, 4-20
- movement to contact, 1-19, 4-44 thru 4-47 (light armor platoon), 5-15 and 5-16 (light armor company), 6-12 and 6-13 (light armor battalion)
- named area of interest (NAI), 2-7, 2-12, 2-15, 6-22
- naval gunfire (NGF), 3-13, 5-7, 7-20 thru 7-22, D-3
- navigation, 2-19 thru 2-21
- net control station, 2-16, 6-16, 8-13
- night attack, 4-60, 5-24
- night operations, 5-6
- noise and light discipline, 2-26
- noncombatant evacuation operations (NEO), 1-2, 3-2 and 3-3, 3-5, 3-7
- nonpermissive operational environment, 1-7
- nuclear, biological, chemical (NBC) support, 1-7, 1-11, 6-27, 7-41 thru 7-43, D-4
- obstacle
  - breaching, 4-39 and 4-40, 5-22 and 5-23, 7-40, B-2
  - emplacement, 4-64, 4-72, 6-5, 7-40 and 7-41
  - plan, 4-64
- offensive operations
  - consolidation and reorganization, 4-59 and 4-60, 5-23
  - fundamentals of, 1-11
  - in built-up areas (BUA), 1-10, 4-49 thru 4-57, 5-20 thru 5-22
  - infiltration, 4-41 and 4-42
  - light armor battalion, 6-12 thru 6-17
  - light armor company, 5-14 thru 5-24
  - light armor platoon, 4-17 thru 4-61
  - movement to contact, 6-12 and 6-13
- operational continuum, 1-1, 1-3 and 1-4
- operational control (OPCON), 1-8, 6-4, 6-8, 6-23, 8-21
- operational environment, 1-7
- operational planning considerations, 4-4 thru 4-7 (light armor platoon), 5-7 thru 5-10 (light armor company), 6-4 and 6-5 (light armor battalion)
- operations and intelligence net (OI), 6-8
- operations order (OPORD), 3-8
- operations other than war, 1-2 thru 1-6, 2-11, 2-13 and 2-14, 3-3 thru 3-5, C-4
- operations security, 1-11, 3-10, 6-21, C-2
  - countersurveillance, 2-22 and 2-23
  - information, 2-24
  - physical, 2-24
  - signal, 2-24
- operations to restore order and intervention, 3-5, 3-7
- opposed entry, 4-76 and 4-77

- orders group, 6-6
- organization
  - air assault battalion, 4-3
  - airborne battalion, 4-3
  - light armor battalion 6-2 thru 6-3
  - light armor company, 5-2
  - light armor platoon, 4-1 thru 4-4
  - light infantry battalion, 4-3
  - light infantry squad, 4-19 and 4-20
- other operations
  - continuous, 2-24 thru 2-27
  - light armor battalion, 6-20 thru 6-28
  - light armor company, 5-34 thru 5-37
  - light armor platoon, 4-76 thru 4-87
- overwatch, 4-19, 4-64, 4-83, 5-4 thru 5-6
  
- passage lane, 4-83
- passage of lines, 2-16, 2-18, 2-21, 4-83 and 4-84, 6-24 thru 6-27
- passage point, 4-83, 6-25 thru 6-27
- passive air defense measures, 4-6, 7-36
- patrols, 4-44
- peacekeeping operations, 1-2, 1-6, 3-4
- peacemaking operations, 1-6
- peacetime contingency operations, 1-1, 1-3
- penetration, 4-43
- perimeter defense, 4-70 and 4-71, 5-29
- permissive operational environment, 1-7
- personnel and administration services, 8-33 and 8-34
- personnel support, 8-33 and 8-34
- petroleum, oils, and lubricants (POL), 6-28, 8-6, 8-14 thru 8-17, 8-24, 8-30
- physical security, 2-24
- planning process, 2-2 thru 2-9
  - abbreviated/hasty planning, 2-8
  - tactical contingency planning, 2-8
- platoon early warning systems (PEWS), 2-24
- position location devices, 2-19 thru 2-21
- positions
  - alternate, 4-65
  - battle, 4-65
  - fighting, 4-64
  - primary, 4-87
  - strongpoint, 4-71 and 4-72
  - supplementary, 4-65
- postal services support, 8-42
- postconflict operations, 3-14
- precombat inspection, 8-23
- predeployment, 3-9 and 3-10, 8-8
- prescribed load lists (PLL), 8-6, 8-9, 8-16 thru 8-18, 8-30
- preventive maintenance checks and services (PMCS), 8-27 and 8-28
- priority intelligence requirements, 5-6, 7-10, 7-34
- priority of work, 8-12
- priority target, 4-64
- prisoners of war. See threat, EPW
- public affairs, 8-33
- pursuit, 1-9, 5-5, 5-20, 6-16
- quarantine and blockade, 3-3, 3-7
- quartering party, 4-79
  
- radar, 2-13, 4-68, 7-17, 7-29 thru 7-31, C-3, D-2, D-4
- radio. See communications
- raid, 4-58, 6-16 and 6-17
- rally points, 4-33, 4-36, 4-38
- react to air attack drill, 4-33
- react to indirect fire drill, 4-33
- readiness conditions, 2-5, 2-21 and 2-22 (Figure 2-6), 2-27
- rear echelon, 3-2

- rear guard, 4-6, 4-44, 5-6, 5-37, 6-12 and 6-13
- rear operations, 6-20, B-3
- rearward passage of lines, 2-16, 6-24
- reconnaissance
  - area, 1-9, 1-12
  - in force, 1-9, 1-12, 4-79, 6-3, 6-21
  - operations, 1-12, 2-26
  - zone, 1-9, 1-12
- reconnaissance and surveillance (R&S), 1-13, 4-76, 6-21, A-3
- redeployment and reconstitution, 3-14
- rehearsals, 2-18 and 2-19, 8-22, 3-9
- relief in place, 4-86 and 4-87, 6-27 and 6-28
- relief operations, 1-2
- religious support, 8-34
- rescue and recovery, 1-7, 3-4
- reserve forces, 1-10, 4-74, 5-4, 5-6, 5-32 and 5-33, 6-17, 6-20
- restrictive fire lines, 4-84
- restrictive terrain, 5-6
- resupply. See also supply
  - by air, 8-7, C-1
  - company LOGPAC, 8-22 thru 8-25
  - emergency, 8-19
  - helicopter, 8-8
  - night, 8-32
  - other methods of, 8-25
  - pre-positioning supplies, 8-19, 8-25 and 8-26
  - routine, 8-18, 8-27
  - service station method, 8-22 thru 8-24
  - tailgate method, 8-22 thru 8-25
- retirement, 1-11 and 1-12, 4-79, 5-6, 5-37, 6-20
- retrograde operations, 1-11 and 1-12, 4-77 thru 4-79, 5-35 thru 5-37, 6-3, 6-20
- reverse slope defense, 4-67 thru 4-69
- roadblocks, 1-2, 4-55, 4-76
- roadmarch, 2-20, 2-26
- role of light armor, 1-1
- rules of engagement, 3-4, 4-81, 7-35
- sabotage, 1-6, 2-12
- safety, 7-28, 8-36
- salvage services, 8-33
- scatterable mines (FASCAM), 1-12, 2-8, 5-7, 7-2, 7-40. See also family of scatterable mines (FASCAM)
- scheme of maneuver, 1-12 and 1-13, 2-7, 3-2, 4-17, 4-24, 4-49, 4-84, 6-26 and 6-27, 7-2, 7-4 thru 7-6, 7-11, 7-14, 7-18, 7-23, 7-34 thru 7-36
- scout platoon, 1-13, 4-4, 5-8, 6-3
- screen, 1-9, 1-12, 5-5, 6-4
- sealift, 3-9 and 3-10
- search and attack technique (movement to contact), 4-44 and 4-45
- sector sketch, 4-64
- security. See also operations security
  - assistance surge, 3-3 and 3-4, 3-7
  - convoy, 5-37
  - for M8s, 4-63 and 4-64
  - force, 4-79, 6-12, 6-17, 6-19 and 6-20
  - information, 2-27
  - light armor battalion, 6-21
  - operations, 1-9, 1-14, 2-25 thru 2-28
- semipermissive operational environment, 1-7
- shoring, 3-9, A-5 thru A-9
- shows of force (and demonstrations), 1-7, 3-3, 3-7
- signal security, 2-24
- sleep plans, 2-25 thru 2-27
- smoke employment, 2-23, 4-6, 4-18, 4-21, 4-35, 4-38 thru 4-40, 4-52, 4-55, 4-58, 4-60 and 4-61, 4-84, 5-7, 5-14, 5-23, 6-6, 6-15, 7-2, 7-15 thru 7-17, 7-19, 7-27 and 7-28, 8-30

- snipers, 4-94
- special operations forces, 3-4, 4-40
- special radio nets, 6-9
- spoiling attack, 6-20
- standing operating procedures (SOP),
  - 1-10, 2-16, 2-24, 2-26, 3-7 and 3-8, 3-11, 6-7, 8-8, 8-13, 8-15, 8-17, 8-21, 8-27, 8-30, 8-33, 8-35 and 8-36, A-3
- Stinger, 1-14, 7-35, A-5, B-2, C-3, D-3
- strikes and raids, 1-2, 3-4, 3-7
- strongpoint, 4-71 and 4-72. See also
  - attack, of a strongpoint; defensive operations, of a strongpoint
- supply. See also classes of supply; resupply
  - battalion LOGPAC, 8-19 thru 8-25
  - company level, 8-17, 8-35 and 8-36
  - distribution of, 8-7
  - in night operations, 8-18
  - phases of, 8-4
  - pre-positioned, 8-25 and 8-26
  - procedures, 8-17
- support
  - by fire, 4-18, 4-24, 5-5
  - considerations, 3-6
  - force, 4-39
  - foreign policy, 3-1
  - platoon, 8-12, 8-14 thru 8-16, 8-19 thru 8-26
- supporting arms liaison team (SALT), 7-3, 7-7, 7-20 thru 7-22, 7-31
- supporting fires, 5-18, 6-15, 6-20
- suppression of enemy air defense (SEAD), 7-28, D-2
- surgical support. See health services support
- surprise and ambush fires, 4-18
- survivability, 7-41. See also mobility and survivability
- sustainment
  - operations, 1-12 and 1-13
  - techniques, 2-30 and 2-31
- tactical air (TACAIR) support, 3-3, 7-23 thru 7-31
  - operations center, 2-26
  - road march, 2-20
- tactics
  - combined arms, 4-25
  - guerrilla/counterguerrilla, 2-12 thru 2-14
  - hit and run, 1-7
  - light armor platoon, 4-79
  - light infantry battalion, 4-40
  - of insurgent forces, 2-12, 2-14
  - small unit, 4-67, 5-30
- talk-through rehearsal, 2-19
- tanks. See M8 light tanks
- target area of interest, 2-15
- target reference point, 2-21, 4-62, 4-65, 5-26 and 5-27, 6-22
- task force trains, 8-11
- techniques
  - of engagement, 4-18
  - of fire control, 4-16
  - of light armor/infantry movement, 4-21 thru 4-24
  - of light infantry movement, 4-19 thru 4-21
  - of movement to contact, 4-44 thru 4-47
  - of using positioning location devices, 2-19 thru 2-21
- terrain
  - affecting M8 positioning, 5-25
  - analysis, 1-11, 2-11 and 2-12
  - arctic, 4-61
  - best use of, 1-13
  - changes in, 4-27
  - desert, 1-7, 4-61
  - forest, 4-61

**terrain (cont)**

- jungle, 4-61, B-1
- key, 1-11, 2-11 and 2-12, 4-65, 4-70, 4-71, 4-74
- mountain, 1-7, 4-61, B-1
- OCOKA factors of, 7-5
- restrictive, 1-3, 1-8, 4-44
- retention of, 4-66, 5-27
- urban, 1-7, 4-50, 4-55, B-1

**terrorism**, 1-2, 1-4 thru 1-6

**thermal sights**, 1-5, 1-13

**threat**, 1-6 thru 1-8

- enemy, 1-6, 3-7, 3-13 and 3-14, 4-4, 4-6, 4-62
- EPW, 1-6 and 1-7, 2-21, 5-23, 8-20, 8-24 and 8-25, 8-33 thru 8-35, A-3, C-2
- evaluation and integration, 2-13 thru 2-15

**training with light infantry**, 3-7

**trains**

- battalion, 8-12, 8-25
- combat, 6-6 thru 6-8, 8-15, 8-18 thru 8-22
- company, 8-11 and 8-13
- echeloned, 8-11
- security of, 8-13
- task force, 8-11
- unit, 8-11

**troop-leading procedures** 2-3 thru 2-5 (Figure 2-1), 2-18, 6-6

**turning movement**, 4-44

**unexploded ordnance (UXO)**, 6-5

**unit maintenance collection point (UMCP)**, 8-12, 8-16, 8-18, 8-25, 8-27 and 8-28, 8-31 and 8-32

**unit ministry team**, 8-12

**unopposed entry**, 4-77, A-1

**urban terrain**, 4-49 thru 4-57. See also **military operations in built-up areas**

**visual signals**, 4-8, 5-9

**walk-through rehearsal**, 2-19

**war (in operational continuum)**, 1-4

**wargaming**, 2-7

**warning order (WO)**, 2-4, 2-6 and 2-7, 2-9, 2-18, 3-9, 5-9, 7-7, 8-3, A-2

**water**

- points, 8-14

- trailers, 8-14

**waypoints**, 2-20 and 2-21

**weapons control status**, 7-35 and 7-36

**weather analysis**, 2-13

**wire communications**, 4-8, 5-9

**withdrawal**, 1-11 and 1-12, 4-78 and 4-79, 5-6, 5-36 and 5-37, 6-16, 6-20

**wounded in action (WIA)**, 8-23 thru 8-25, 8-35, 8-37

**X-hour preparation sequence**, 3-9

**FM 17-18**  
**8 MARCH 1994**

By Order of the Secretary of the Army:

Official:

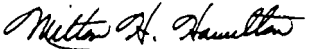
  
MILTON H. HAMILTON  
Administrative Assistant to the  
*Secretary of the Army*  
06056

GORDON R. SULLIVAN  
*General, United States Army*  
*Chief of Staff*

**DISTRIBUTION:**

Active Army, USAR, and ARNG: To be distributed in accordance with DA Form 12-11 E, requirements for FM 17-18, Light Armor Operations (Qty req block no. 5086).